

POPULAR ELECTRONICS BY RAYMOND FRANCIS YATES  
RADIO'S GREATEST MAGAZINE

# RADIO-CRAFT

Incorporating  
**RADIO & TELEVISION**

HUGO GERNSBACH, Editor



See Page 275

★ ★ ★ ★ ★ ★ ★ ★ ★ ★  
**MANY ARTICLES  
FOR THE  
RADIO  
BEGINNER**

FEBRUARY  
**25¢**  
NADA 30¢  
1943

OVER 100 ILLUSTRATIONS



# Listening Posts!

You will find Hallicrafters Communications Equipment working three shifts at our Country's "Listening Posts"... searching the airways for illegal programs and espionage messages.

Hallicrafters Communications Equipment is engineered to "take it" on this constant operating... there are no rest periods, no time out, it's constant performance!

The Hallicrafters Equipment you can buy—when communications equipment may again be sold for Civilian use—will incorporate all of the endurance and top quality performance you will ever demand.

Illustration—typical view of Hallicrafters Communications Equipment is a monitoring (listening in) station—somewhere in the U.S.A.

WORLD'S LARGEST EXCLUSIVE MANUFACTURER OF SHORT WAVE  
RADIO COMMUNICATIONS EQUIPMENT



# hallicrafters

CHICAGO, U.S.A.



Is this what you want to know?

# I Will Train You at Home KNOW RADIO for Good Wartime and Peacetime Jobs



Knowing the answers to questions like those above, and others which arise while doing work as a Radio Technician or Operator, has spelled the difference between success and failure for many men. Such knowledge represents the difference between a skilled, well-paid Radio Technician or Operator and the too-common "Radio screw-driver mechanic." If you do not know the answers, if you want to make more money in Radio. I will teach you at home in your spare time. I will train you to be a Radio Technician or Operator whether you are already in Radio or are a beginner without knowledge or experience.

Mail the Coupon. I will send you a Sample Lesson from my Radio Course FREE. You'll see that it is practical to train at home in spare time to be a Radio Technician or Operator. And with this lesson I'll send my 64-page illustrated book, "RICH REWARDS IN RADIO." It describes the many fascinating jobs Radio offers, tells how you can go after these good wartime and peacetime opportunities.

How the "N.R.I. Method" Helps Many Win Jobs Paying \$30, \$40, \$50 a week

The up-to-the-minute Radio Technician or Operator must have BOTH theoretical knowledge and a practical understanding of how to apply Radio principles. I give you thorough

**EXTRA PAY IN ARMY, NAVY, TOO**

Men likely to go into military service, soldiers, sailors, marines, should mail the coupon now! Learning Radio helps men get extra rank, extra prestige, more interesting duties. **MUCH HIGHER PAY.** Also prepares for good Radio jobs after service ends. Over 1,700 service men now enrolled.

training in Radio Theory—show you how to use your knowledge. N.R.I. trains you "from the ground up"—covers fundamentals thoroughly: Radio Terms, Symbols, Diagrams, Receiver Troubles, Servicing, Television, FM Receivers, Transmitters, Cathode Ray Oscilloscopes, Electronic Controls, etc. These are just a FEW of the subjects you'll cover before you finish my Course!

**Beginners Quickly Learn to Make \$5, \$10 a Week Extra in Spare Time**

Many N.R.I. students make \$5, \$10 a week extra money fixing Radios in spare time while still learning. I send **EXTRA MONEY JOB SHEETS** that tell how to do it. Many N.R.I. graduates start their own full time Radio businesses. Others take interesting jobs with Broadcasting Stations, Radio Manufacturers, rushing to fill Government orders, need more trained men. Radio Technicians and Operators are needed for Good Civilian jobs with the U. S. Government, Aviation, Police, Commercial Radio and Public Address Systems need trained Radio men. And think of the **NEW** Radio jobs that Television, Frequency Modulation, and Electronics will open after the war! I give you the Radio knowledge required for these jobs.

**Let This Great Organization Help You**

Throughout your training, the staff and resources of the world's largest home study institution devoted to training men for Radio will be squarely behind you. N.R.I. has stuck to the one job of teaching Radio for 23 years. My entire staff devotes full time to Radio training. Our combined efforts have made the Course so interesting, with hundreds of pictures, charts, and diagrams—so easy-to-grasp, with special teaching methods designed especially for home training—that we believe you will be "old friends" with Radio almost before you know it.

**START NOW—Mail Coupon for FREE Lesson and Book**

**MAIL THE COUPON**—I'll send you the FREE lesson and my 64-Page Illustrated book, "RICH REWARDS IN RADIO." No obligation. You'll see what Radio offers YOU. And you'll have my FREE lesson to keep. No salesman will call. Just **MAIL THE COUPON NOW!**—J. E. Smith, President, National Radio Institute, Dept. 3BX, Washington, D. C.

**TRAINING MEN FOR VITAL RADIO JOBS**

1. How to read Radio diagrams and analyze them.
2. How to run a Radio service shop successfully.
3. How to use and operate electronic controls.
4. How to locate parts in a chassis with and without service data.
5. How to know the cause of receiver trouble from observed effects.
6. How to make tests which isolate the defective stage and parts.
7. How to align Radio receivers without reference to specific instructions.
8. Short cuts in servicing midget universal receivers.
9. Learning how Radio circuits work through home demonstrations.
10. How to obtain additional basic Radio training for military, naval and war industry Radio jobs.
11. How accurately timed pulses are produced and used.
12. How the cathode ray tube works and is used.
13. How to adjust a Radio transmitter for best operation.
14. How to service without specialized servicing equipment.
15. How transmitters are modulated and keyed.
16. How Radio-electronic devices are used commercially as controls.
17. How Radio meters and testers work and how to use them.
18. How Radio waves are beamed and intercepted.
19. How Radio equipment is automatically and remotely controlled.
20. How a frequency modulated system works.
21. How timed circuits effect Radio circuit operation.
22. How the superheterodyne receiver works.

## Sample Lesson FREE

I will send a Sample lesson, "Getting Acquainted with Receiver Servicing," to show you how practical it is to train at home for a good-pay Radio job. It's a valuable lesson. Study it—keep it—without obligation. Tells how to fix Electrodynamic Loudspeakers, Output Transformers, Gank Tuning Condensers, I. F. Transformer—how to locate defective soldered joints—Antenna, Oscillator Coil facts—Receiver Servicing Technique—dozens of hints, facts, explanations. Get your copy at once—mail coupon NOW!



### GOOD FOR BOTH 64 PAGE BOOK SAMPLE LESSON FREE

**J. E. Smith, President, Dept. 3BX National Radio Institute, Washington, D. C.**

Mail me FREE without obligation, Sample Lesson and 64-page book, "Rich Rewards in Radio," which tells about Radio's opportunities and explains your 50-50 method of training men at home. (No salesman will call. Write plainly.)

Age .....

Name .....

Address .....

City ..... State ..... 4FR-2

# RADIO-CRAFT

Incorporating

**RADIO & TELEVISION**

**HUGO GERNSBACK**  
Editor-in-Chief

**KARL E. SCHUBEL**  
Associate Editor

**FRED SHUNAMAN,**  
Technical Editor

**G. ALIQUO**  
Circulation Manager

Contents **FEBRUARY, 1943** Issue

**VOLUME XIV -- NUMBER 5**

|  |     |
|--|-----|
| Mailbag .....  | 260 |
| Editorial: One War We Are Still Losing ... by Hugo Gernsback | 263 |
| Nikola Tesla .....   | 264 |
| English Women Spot Nazi Planes (Cover Feature) .....         | 275 |

## ELECTRONICS

|   |                              |
|---|------------------------------|
| Popular Electronics, Part I .....                                       | by Raymond F. Yates 266      |
| Capacitance Becomes Boss .....  | by C. Peter Johnson, Jr. 269 |
| Air Raid Alarms by Electronic Means .....                               | by Werner Muller 270         |
| Electronic Phono Pickup .....   | by Leslie Gould 271          |
| A Versatile Square Wave and Pulse Generator Part II<br>by Warren Miller | 272                          |
| Electronics Explodes Rivets and Glues Plywood .....                     | 273                          |
| Modern Aladdin's Lamp .....   | 274                          |
| Electronic Spot Welding .....   | 275                          |
| Recent Electronic Developments .....                                    | 275                          |

## WARTIME RADIO

|                                     |     |
|-------------------------------------|-----|
| Radio Logs Plane Data .....         | 276 |
| 50,000 Watter on Air From Rio ..... | 276 |

## RADIO INSTRUCTION

|  |     |
|--|-----|
| Radio Training in the Air Forces ..... | 277 |
|--|-----|

## SERVICING

|   |                           |
|---|---------------------------|
| Wartime Tube Replacements .....   | by Harold Davis 278       |
| <b>RADIO SERVICE DATA SHEET:</b><br>No. 330 Firestone Model No. S7406-7 ..... | 280                       |
| Aligning Superhets .....  | by Alfred A. Ghirardi 282 |
| Tentative List of Replacement Parts .....                                     | 283                       |
| Servicing Notes .....   | 283, 309, 310             |

## EXPERIMENTERS

|                                  |                        |
|----------------------------------|------------------------|
| Lenz' Law in Modern Speech ..... | by Fred Shunaman 284   |
| The Super T.R.F.-Nine .....      | by Ralph W. Martin 285 |
| A Real Phono Oscillator .....    | by F. E. Marsh 286     |

## TEST INSTRUMENTS

|  |                        |
|--|------------------------|
| A Simplified Electronic Voltmeter, Part II ..... | by Harold Davis 287    |
| Using the Old Meter .....                        | by John R. Kearney 288 |

## IN THE NEXT ISSUE

The March issue will contain the following:

- Carrier Communications
- The "Simplicity-1" Electrified
- Radio Direction Finding
- Tone Correction Filters and a further selection of articles for the
- **RADIO BEGINNER**

## SOUND

|  |                          |
|--|--------------------------|
| Practical Audio Amplifier Theory, Part I ..... | by Ted Powell 290        |
| Two-Way Inter-Communicator .....               | by Joseph H. Criscom 291 |

## BEGINNERS

|   |                          |
|---|--------------------------|
| Beginner's Dollar Radio .....                                     | 294                      |
| R. F. Amplifiers .....  | 296                      |
| R.M.A. Color Codes For The Beginner .....                         | 297                      |
| The Beginner's "Plasticette" Receiver .....                       | by Homer L. Davidson 298 |
| Automatic Volume Control in Broadcast Receivers<br>by S. J. Naste | 299                      |

## DEPARTMENTS

|   |                    |
|---|--------------------|
| Mailbag .....   | 260                |
| <b>RADIO SERVICE DATA SHEET (See Servicing)</b> ..... | 280                |
| Servicing Notes .....                                 | 283, 309, 310      |
| Latest Radio Apparatus .....                          | 293                |
| Question Box .....                                    | 300                |
| Radio Hook-ups .....                                  | 302, 303, 304, 306 |
| Radio Kinks .....                                     | 313, 314           |
| Book Reviews .....                                    | 319                |

★

Published by Radcraft Publications, Inc. Publication office: 29 Worthington Street, Springfield, Mass. Editorial and Advertising Offices: 25 West Broadway, New York City. Chicago Advertising Office: RADIO-CRAFT, 520 North Michigan Avenue, Chicago, Ill.

RADIO-CRAFT is published monthly, on the first of the month preceding that of date; subscription price is \$2.50 per year in U. S. (In foreign countries, 75c additional per year to cover postage; Canada, 50c additional.) Entered at the post office at Springfield as second-class matter under the act of March 3, 1879. All communications about subscriptions should be addressed to: Radio-Craft, 25 West Broadway, New York, N. Y.

★

Foreign Agents:

London—Gorrings' American News Agency, 9A Green St., Leicester Square, W. C. 2, England.

Melbourne—McGill's Agency, 179 Elizabeth St., Australia.

Dunedin—James Johnston, Ltd., New Zealand.

★

Text and illustrations of this magazine are copyright and must not be reproduced without permission of the copyright owners.

★

Copyright 1943 Radcraft Publications, Inc.

# 7 Days FREE TRIAL

Costs You Nothing to Examine This Amazing New Three Volume Set of REFERENCE BOOKS OF PRACTICAL



# ELECTRICITY

Each Book 8½ x 11 inches. Handsomely Bound in Harvard Red and Gold Leatherette.

**AT LAST!** A set of electrical books written in clear, understandable language for the "beginner" or "old timer." Solves your everyday electrical problems easily, quickly and thoroughly.

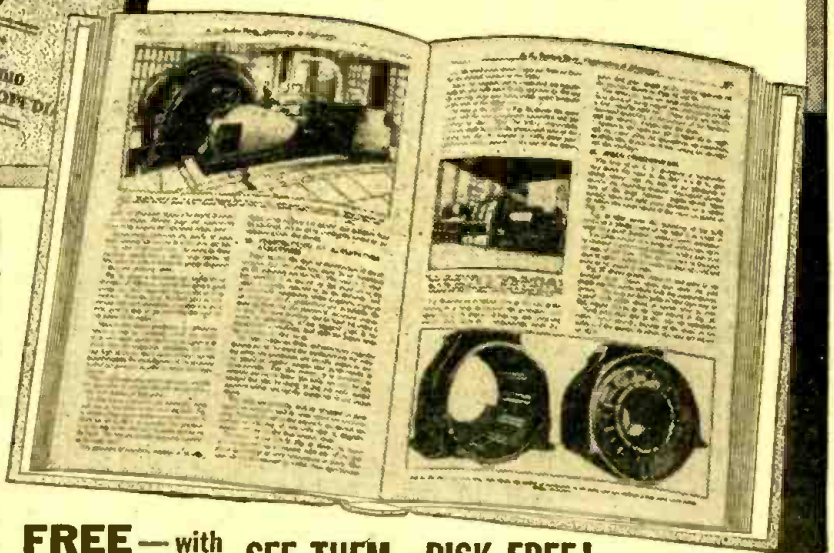
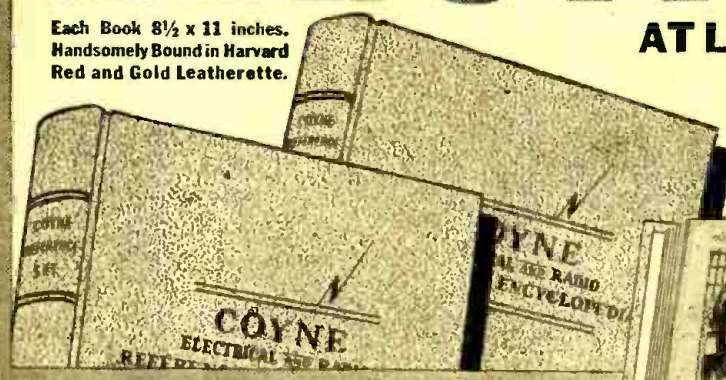

## SEND NO MONEY! COUPON BRINGS COMPLETE SET!

Now at last, it's easy, practical to get a knowledge of Electricity at home. Whether you want to learn Electricity or whether you are now doing electrical work, you need these books.

**AUTHORITATIVE. PRACTICAL**—prepared by experts. Used regularly on the job by hundreds of Electricians, service men, radio men, air cadets, students, maintenance men, etc. **EASY. COMPLETE.** Covers everything Electrical: Armature winding, A.C. and D.C. Motors, generators, electronics, automotive electricity, refrigeration, etc., etc. Answers your electrical questions quickly, clearly, completely. Also includes Radio, Television.

**FREE**—with Reference Books  
Send for these reference books now, and I'll include 1 full year of Technical Service—personal advice by mail on any Electrical or Radio subject.

## SEE THEM—RISK FREE!

Don't send a penny. Simply mail coupon below and receive your set. Examine books 7 days, with no obligation. Then, if you decide they are the finest, most practical reference set you ever saw, send \$3, and the same amount monthly until total price of \$12 is paid. I'll prepay all shipping charges. Offer is limited. Mail coupon NOW.

**H. C. LEWIS, Pres., COYNE ELECTRICAL SCHOOL**  
500 So. Paulina St. Dept. 23-T2 Chicago, Ill.

## HUNDREDS OF PICTURES AND DIAGRAMS! HUNDREDS OF ELECTRICAL SUBJECTS AT YOUR FINGER TIPS!

A few of the many branches of Electricity explained and pictured in this amazing set are:

- |                  |                 |                |
|------------------|-----------------|----------------|
| Air Conditioning | Refrigeration   | Power Plants   |
| Telephony        | House Wiring    | Diesel Engines |
| Auto Electricity | Electric Signs  | Motors         |
| Talking Pictures | Home Appliances | Armatures      |
| Generators       | Switchboards    | A.C. and D.C.  |

\*Complete Ready Reference Index of over 2000 listings tells you instantly where to look up any electrical fact.

H. C. LEWIS, Pres.  
COYNE ELECTRICAL SCHOOL  
500 S. Paulina St., Dept. 23-T2  
Chicago, Ill.

## NO RISK COUPON

Send me the big 3-volume Coyne Electrical and Radio Encyclopedia, postpaid. Within 7 days after receiving the books, I'll either return them or send you \$3, and \$3 a month until advertised price of \$12.00 is paid.

NAME.....  
 ADDRESS.....  
 CITY.....STATE.....  
 OCCUPATION.....AGE.....  
**SAVE 10%**—Send cash price, \$10.80, with order if preferred—you save \$1.20. Same 7-day free trial and return privilege.



**4 STANDARD TYPES**  
of Amperite Regulators replace over 400 types of AC-DC Ballast Tubes now in use.  
Amperites are real REGULATORS... have patented Automatic Starting Resistor which prevents initial surge and saves pilot lights... Ask Your Jobber.

**AMPERITE**  
THE *Simplest* WAY TO REPLACE **BALLASTS**

WRITE FOR REPLACEMENT CHART  
AMPERITE Co. 541 BROADWAY, NEW YORK, N. Y.



**Centralized Service on everything in Radio and Electronics**

Reach for your **ALLIED** Catalog...

Get Everything in Radio and Electronics from this one central arsenal of supply—over 15,000 items for the Armed Forces, for Radio Training, for Research Laboratories, for War Industries, and for Service Replacement. Our complete stocks speed delivery. Our experienced staff can help you.

Send for your Free Allied Buying Guide

Send for the new "ALLIED'S Radio-Formula and Data Book"

For Radio Students, Instructors, Technicians, Engineers. Contains valuable Formulas, Tables, Data and Standards commonly used in Radio and Electronics... 10c

**ALLIED RADIO CORP.**  
833 W. Jackson Blvd., Dept. 2-B-3, Chicago

**ALLIED RADIO**

## MR. RISK AND MR. MOODY

Dear Editor:

I have just received my copy of the December issue of your magazine. In the Mailbag section I notice a letter from George Risk, Omaha, Nebraska.

I realize that due to the difficulty of obtaining employees at the present time the editor of a magazine such as yours is extremely overworked, and as such cannot spend the time necessary to weed out letters such as these. For you see, Mr. Risk's difficulty arises not from an error in the article, but in his lack of understanding of electrical nomenclature. He does not distinguish between *current flow* which is from + to -, and *electron flow* which is from - to +. His explanation as given in his letter is perfectly correct, showing that he has evidently had a good background in electricity.

There are thousands of magazine readers like Mr. Risk, who have a good understanding of radio and a capacity to learn, but have not done so because they spend their time studying, not textbooks, but radio magazines, which refuse to allow space to authors of articles in radio fundamentals, but fill their pages with constructional and theoretical articles such as those of Mr. Moody which profess to explain to the reader the intricacies of the most complex subject in radio but which are, in actuality, lifts from highly mathematical electrical engineering texts glued together with paragraphs of Moody's own making.

The mathematical formulae no doubt duly impress (and scare out of their wits) the least technically minded reader, but the paragraphs written by Moody himself would be ludicrous were it not for the fact that he makes his statements in the utmost sincerity.

Take for instance his "Standards of Measurement" in *Radio-Craft* for August-September 1942. In this article he states that an erg of work is expended when one gram is raised one centimeter in one second. He then makes the statement, in the same article that a force of one dyne is required to move a mass of one gram one centimeter in one second.

A high-school sophomore blindfolded and with one hand tied behind his back could not have made so many statements and have gotten every one wrong. In this issue (December) of *Radio-Craft*, Mr. Moody states that power and work are synony-

mous! This is a flagrant error of course, and should have a correction notice posted in the next issue.

His mistakes are not limited to fields other than electrical, however, for in this same issue (December), he misleads readers such as Mr. Risk by stating that "megohms" can be substituted in the Ohm's law formula without being converted to ohms. PLEASE point out that if this is

done the fundamental formula  $I = \frac{E}{R}$

the current will be in *microamperes* and not *amperes*

It is an interesting fact that I have never read one of Moody's articles in *Radio-Craft* or *Radio News* that did not have some error in it.

The question is this: Why does a magazine "for the beginner," such as you advise on your cover, waste space and money in articles such as those of Mr. Moody and yet refuse to allow space for instructional articles on the fundamentals of radio, which your readers evidently desire?

EARL RAYMOND PETERSEN\*  
Pasadena, Calif.

\*Radio Instructor (ESMWT), Radio Amateur, Radio Serviceman (formerly), Radio Operator (Commercial).

(Mr. Petersen's letter brings to the fore the question of current flow versus electron flow. Those acquainted with the obvious confusion simply go by the rule that it makes no difference which concept is used, provided one sticks to it in his discussion.)

(As regards Mr. Moody, we hope that our readers understand that there must be something intermediate between beginners' A, B, C's, and the transcendental realms of the engineer. Mr. Moody in his articles tries to bridge this gap. His articles are valued by students who tie up his renditions with those of others for confirmation and expansion.)

(As regards ergs, dynes and centimeters, little harm is done, for any textbook tells us a dyne-centimeter is an erg; a unit of work. Work done in a certain time (rate) is power.)

(If Mr. Petersen believes he has something "for the boys" and if the boys would like to have it, *Radio-Craft* would gladly print it. We try to keep on our toes.—Editor)

### "THE SASKATCHEWAN"

Dear Editor:

In reply to your letter, received well over a month ago I am sending you another diagram. This is similar to the one I sent you before, except that it employs a 1A5GT instead of a 34 tube, and I have worked out a regeneration control.

This may be run from a power pack with plenty of volume. Set it on your loudest station, try a speaker on it and I am sure you will be delighted with all the pep that one tube has in it.

JOSEPH NIWRANSKI,  
Brooksby, Sask.

Mr. Niwranski's set is interesting and well-worth experiment and development by our readers (for diagram, see Hookup Section). It will be remembered that when the screen-grid tube first came out it was expected to have a greater future as a space-charge device than as a shield-grid tube—in fact the value of the "screen-grid" was almost entirely overlooked.

Now it is the space-charge feature which has sunk into the obscurity from which Mr. Niwranski is trying to rescue it.—Editor

### PHONO OSCILLATOR WORKS

Dear Editor:

In your December issue of *Radio-Craft*, you published an article and diagram of a phono-oscillator on page 182.

I think there has been an error either by Hadley M. Hopper who submitted the article or by the publishers.

In the diagram the signal is fed into the oscillator grid and the oscillator is connected to the control grid. If this procedure is followed, a poorly distorted signal if any is the result.

With the connections to these grids reversed the oscillator works very nicely.

CLIFFORD V. LOCKMAN,  
Kelly Field, Texas

(Mr. Hopper has tried the circuit and knows whereof he speaks. The diagram was printed because of its novelty, and like many circuits in the Hook-Up section, is intended to be experimented with. Other experimenters might try other tricks with it.—Editor.)

**CURRENT FLOW**

Dear Editor:

In a letter appearing in the December issue of *Radio-Craft* Mr. George Risk criticized several statements of the article, "Tracking Down Grid Emission," which appeared in the October issue of *Radio-Craft*. While Mr. Risk was right some of the time, he did err in some places.

Mr. Risk quoted the portion of the article that stated that because of grid emission a current would flow from the grid, through the various resistors to ground. Quoting this, he stated that since the current flows from negative to positive, that naturally this would put a more negative bias on the grid.

Mr. Risk overlooked one thing: The article was written on the assumption that current flows from plus to minus. All radiomen know that this is not technically correct; however, in radio work this is the standard that has been adopted and it makes no difference in the workings of a circuit. If Mr. Risk wishes to use his "minus-to-plus" rule, he will have to reverse the direction of flow of all the currents described in the article. He will then find that the grid becomes positive with grid emission as every radioman well knows.

And now about whether the electrons emitted by the grid, flow to the plate or the cathode. An electron emitting grid acts as a cathode. The whole problem is, which has the highest positive potential as meas-

ured from the grid; the tube cathode or the plate? Let us take an example. Suppose we have a tube with the grid exactly half way between the heater and plate; the bias is 25 volts and the plate is 100 volts (as measured from the cathode). As measured from the grid, the voltages would be plus 25 for the cathode and plus 125 for the plate. Five-sixths of the electrons would flow to the plate; one-sixth to the cathode. As tubes of higher mu are used, the number of electrons attracted by the cathode and the plate become more nearly equal.

Contrary to Mr. Risk, there most definitely would be a flow of electrons to the cathode when grid emission takes place, especially in hi-mu tubes. However, he was correct in assuming that there is a flow of electrons from the grid to the plate because, of course, that is the flow which is predominant.

I hope that the preceding will clear up, somewhat, the misunderstanding which was created by the "Grid Emission" article and Mr. Risk's letter.

I feel that it would be unfair not to tell you how much I enjoy your magazine. You are doing a great thing in publishing so many beginner's articles. They are just what we need right now when so many thousands of people are suddenly breaking into the field of radio.

MERL BECKMANN,  
Clarkson, Wash.

**MR. RISK AND ELECTRONS**

Dear Editor:

I fear that reader George Risk of Omaha, in his letter in your December issue, has made the often committed mistake of confusing electron flow and current flow.

Electrons are negatively charged particles and therefore flow from negative to positive. However, before anything about electrons was discovered, it became necessary to adopt some convention. Unfortunately, a wrong guess was made, for the convention adopted was that current flows from positive to negative.

Mr. Risk's complaint was about certain statements made in connection with figure 1 on page 14 of the October, 1942 issue. The solution is simple. The first tube receiving AVC bias has its grid emitting electrons. These electrons can come only from ground and they move from ground through the volume control, through resistor R to the grid and are emitted. Since electrons flow from negative to positive, the ground side of R is more negative than the point X, as

pointed out in the article. Mr. Risk went wrong when he said, "current always flows from negative to positive." Current always flows from positive to negative, electrons from negative to positive.

The one error I do find in this article is the statement that current flows from diode to grid. In normal operation, electrons flow from diode plate to ground causing the AVC voltage to be developed across the volume control, the grid side being more negative than ground. In normal operation no current should flow through R; the combination of R and the condenser to ground being a filter through which the bias is applied. By normal operation is meant no grid emission, etc.

A fairly good understanding of AVC circuits can be obtained from the RCA tube manual, page 29, series RC-14.

My compliments to Mr. Risk for his interest shown by writing and to the editors for a fine publication.

MATTHEW SHAPIRO,  
Brookline, Mass.

**JAPANESE-AMERICAN RADIO MAN**

Dear Editor:

I was very glad to receive my first copy of *Radio-Craft* and once more become a subscriber to your magazine.

In accordance with your announcement in the November issue of *Radio-Craft*, I wish to make an application for radio work.

I am an American citizen of Japanese ancestry and thereby have been placed by military ruling in a WRA project camp. This, I now understand, has been done for my protection. However, ever since my arrival here I have wanted to do my part to help the United States win this war. We are permitted to leave this project upon assurance of employment and so a few months ago I volunteered in the harvesting of sugar beets in Idaho, where the scarcity of labor was becoming serious. This type of work is only seasonal and I feel that I

can do more for the war effort by applying for employment in radio industries and list below my qualifications and experience.

I am twenty-seven years old and married. I majored in vocational electricity and shop in high school at Berkeley, California, and had two and one-half years of electrical engineering at Modesto Junior College. I have also taken a correspondence course in radio television. On this project I have been employed as a sound technician.

My records are now being cleared through the Army and FBI, pending the release of my permit to leave this project for any location outside of the Western Defense Area for employment.

I will greatly appreciate it if you will transmit my name to the available list for radio work.

SEIICHI OTOW,  
Newell, Calif.



It's the way Ohmite Resistors are designed and built that makes them so reliable for today's critical service on the war front, and the home front. These sturdy, wire-wound units stay accurate, prevent burnouts and failures—insure permanent performance under the toughest operating conditions from the arctic to the tropics.

This is your best assurance in maintaining the service of existing equipment or in developing new devices to defeat the enemy and build for tomorrow's peace.

**Send for These Handy Aids**



Ohm's Law Calculator—Helps you figure ohms, watts, volts, amperes—quickly, easily. Solves any Ohm's Law problem with one setting of the slide. All values are direct reading. Available for only 10c. (Also available in quantities.)

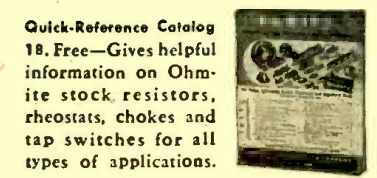

Quick-Reference Catalog 18, Free—Gives helpful information on Ohmite stock resistors, rheostats, chokes and tap switches for all types of applications.

Authorized Distributors Everywhere

Ohmite Mfg. Co., 4895 Flournoy St., Chicago



# OFF THE PRESS!

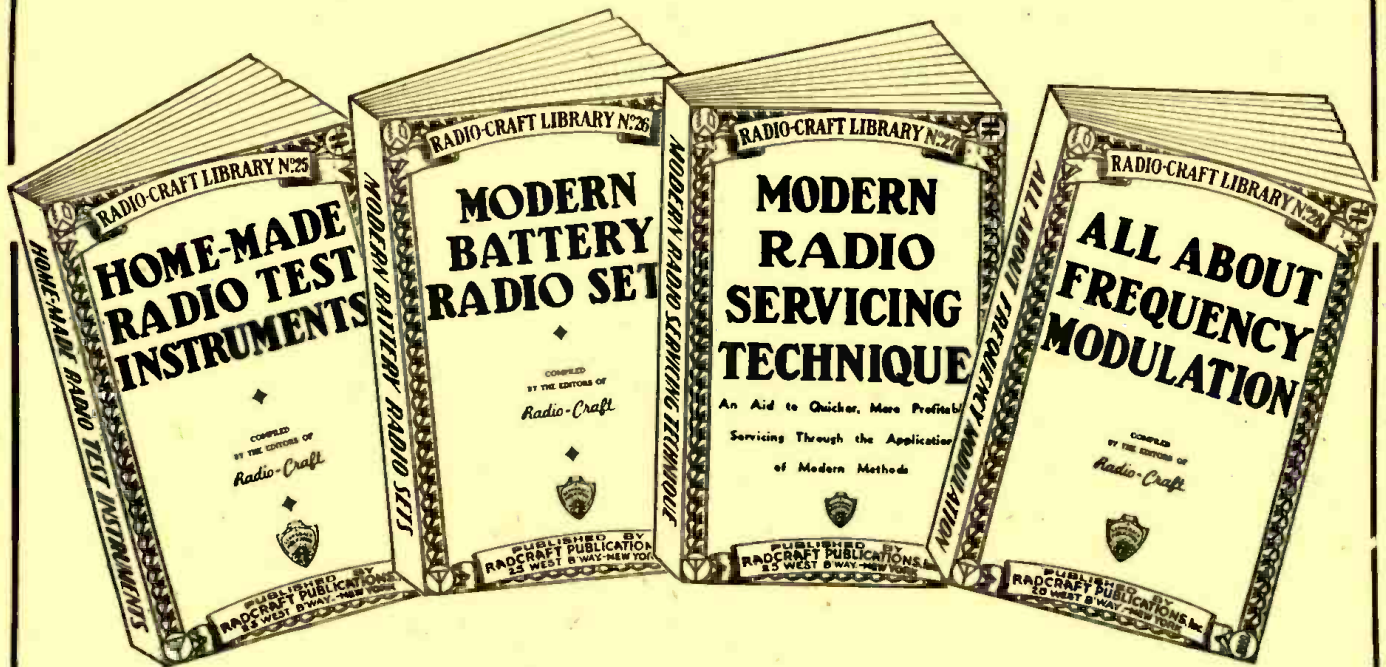

## New RADIO-CRAFT Library Books

THE four latest books of our well-known RADIO-CRAFT Red Books—Nos. 25, 26, 27 and 28—have just come off the press.

These four books are all on timely subjects and we recommend every one of them to you sincerely.

Now, more than ever, radio education has become a burning question. If you are to be in the National Service; in the Army, Navy or Air Force—practical radio knowledge is of paramount importance. **YOU CAN GET BETTER RATINGS AND ADVANCE QUICKER IF YOU HAVE A GOOD RADIO BACKGROUND.**

Conversely, if you are not with the armed forces, there is a whole of a job to be done at home. With more and more men going into the service, the demand for practical servicemen becomes greater each day. Therefore we say: **PROFIT BY THESE UNIQUE BOOKS, WHICH ARE PRICED SO LOW THAT THEY ARE WITHIN THE REACH OF EVERYONE'S PURSE.**

### No. 25—HOME-MADE RADIO TEST INSTRUMENTS

This book includes articles covering a wide range of test apparatus of live interest to every radio man. Servicemen will find many circuits in this book to make their work more profitable. New ideas in test equipment make it possible to service radio receivers more quickly.

Laboratory workers and experimenters will find many articles which describe in detail construction and use of all essential radio test units—multi-meters, oscillators, stage-analysis testers, oscilloscope equipment, V. T. voltmeters, etc. Even advanced technicians will be interested in the circuit arrangements showing the new and improved variations of well-known, basic test equipment. A MUST for every serviceman. This book contains 86 illustrations.

Outline of Contents: A Low-Cost Signal Chaser—Signal Tracer Test Unit—Simplified Practical Signal Tracer—A Home-Made Infinite-Resistance Tube Checker—Build This Direct-Reading V.-T. Voltmeter—How to Make a Modern V.-T. Voltmeter—Measuring High Values of A.C. Voltage and Current With a Low-Range Meter—How to Make a Meter-Range Extender—How to Build a Practical Tube Tester and Set-Analyzer Adapter—The Beginner's Simple Volt-Milliammeter—Build This Simplified Neon-Tyoe Test Unit—Midget Oscilloscope—How to Make and Use a Frequency Wobbler—Double Tracing Your Oscilloscope—Home-Made Frequency Modulator.

### No. 26—MODERN BATTERY RADIO SETS

Whether you are a radio man or a beginner, the articles in this book give you basic circuit arrangements or elementary radio receivers which serve the dual role of teaching the elements of radio reception, as well as making perfectly operating 1- and 2-tube radio receivers. Picture diagrams and bread-board layouts follow.

Advanced radio set builders are offered more complicated arrangements. Laboratory workers and engineers will find in many of the articles circuit and constructional features which have become commercial practice. Many entirely new ideas are given in this book. One of the most important volumes we recently issued. This book contains 76 illustrations.

Outline of Contents: Beginner's 1-Tube High-Gain All-Wave Receiver—Beginners-Build This 1-Tube Loop Receiver—A "3-in-1" Battery Portable—An Easily-Built "Fluorescing Superregenerative" 2-In-1 "Card File" Battery Set—A 2-Tube Superhet. With Pentagrid Regenerative 2nd-Detector—The 4-Tube Superhet. Vacation Portable—The "Lunchbox 5" Battery Portable—"The Seafarer" Loop-Type Boat Radio Set—4-Tube Permeability Portable—An All-Purpose Portable—A Typical Commercial 3-Way Portable (Pilot Models X-1452 and X-1453)—Switch for Varying "C" Bias on Battery Radio Sets—Making a Simple Portable Aerial—Making a Pilot-Light Fuse—Old Auto Sets for New Cars—Using a Loop Portable in Cars—Quasi-Electric Soldering Iron—Lamp Bulbs as Resistors.

### No. 27—MODERN RADIO SERVICING TECHNIQUE

Here is a book of great importance to every radio man, every radio engineer, and particularly all radio servicemen. A list of the contents which follows shows the importance of this book, literally jam-packed with over-flowing with radio-meat. Whether you are a servicing beginner or whether you are an experienced serviceman—you will find many important helps in this volume.

Book is eminently practical and will solve many problems for you. More important: It will show you many short-cuts, all calculated to save your time and patience. Practical everyday data on standard receivers appears throughout the book. A whole of a book compressed into a minimum of space. Contains 98 important illustrations.

Outline of Contents: Elementary Servicing Technique—Correct Procedure for the Servicing Beginner—Elementary Procedure for Servicing Radio Sets—A.F.C. Alignment Made Easy—Dynamic Servicing—Dynamic Testing Simplifies Servicing—Modern Receiver Test Requirements—Servicing Universal A.C.-D.C. Receivers—Servicing "Orphans" and Private-Brand Sets—Emergency Servicing Without Test Meters—Servicing Coils—Servicing R.F. Coils—Servicing Oscillator Coils—General Information—RMA Transformer Color Code—What Causes Echo, Fading?—Radio Service Puzzlers.

### No. 28—ALL ABOUT FREQUENCY MODULATION

Here is a complete compilation of pertinent data on the entire subject of the new coming art of Frequency Modulation.

There is no question but that Frequency Modulation is already revolutionizing radio broadcasting in this country. Were it not for the war, there would now be a tremendous boom in this new art—yet, even with war restrictions imposed upon it, Frequency Modulation is still jumping ahead by leaps and bounds.

With Frequency Modulation no longer a theory—with hundreds of stations already dotting the land and with countless hundreds of others to come when peace is achieved once more—every radio man should read up and know all there is to know on this most important subject.

This particular handbook is chuck-full with a tremendous amount of information which you probably will not find in any similar book in print.

Outline of Contents: The ABC of F.M.—Frequency vs. Amplitude Modulation—Basic Facts About F.M. Broadcasting—Construction—Build This Practical F.M. Adapter—Audio Amplification—F.M. Audio Amplifier, Part 1—F.M. Audio Amplifier, Part 2—F.M. Audio Amplifier, Part 3—F.M. Service—Part 1, Antenna Installation and Service—Part 2, Receiver Alignment and Diagnosis—Part 3, Test Equipment for F.M. Servicing, Engineering—Part 1, The How and Why of F.M.—Part 2, The How and Why of F.M.—Theory and Design Considerations of R.F. and I.F. Coils in F.M. Receivers.

### SPECIAL SEND-NO-MONEY OFFER

It is not necessary that you send money with order. If you wish to take advantage of our C.O.D. plan, simply cut out the coupon, paste it on a post card and send it to us. Books will be sent to you immediately.

All four books are listed uniformly at 50c each. No discount on less than three books.

If you wish to take advantage of our special offer, ordering three books or more, we make an unusual low price to you as follows:

3 books—\$1.25  
4 books—\$1.50

Do not fail to send coupon today!

RAD-CRAFT PUBLICATIONS, INC.  
25 West Broadway, New York, N. Y.

|   |  |     |
|---|--|-----|
| RAD-CRAFT PUBLICATIONS, INC.  |  | 243 |
| 25 West Broadway,<br>New York, N. Y.  |  |     |
| Gentlemen:  |  |     |
| Push to me by return mail, as per your special offer, the following books: (Check books selected.)  |  |     |
| <input type="checkbox"/>  | No. 25—HOME-MADE RADIO TEST INSTRUMENTS. |     |
| <input type="checkbox"/>  | No. 26—MODERN BATTERY RADIO SETS.        |     |
| <input type="checkbox"/>  | No. 27—MODERN RADIO SERVICING TECHNIQUE. |     |
| <input type="checkbox"/>  | No. 28—ALL ABOUT FREQUENCY MODULATION.   |     |
| I will pay postman \$1.00 (if two books are ordered) plus a few cents postage and charges, \$1.25 for three books, plus a few cents postage and charges, \$1.50 for four books, plus a few cents postage and charges. WE CANNOT SEND A SINGLE 50c BOOK C.O.D. |  |     |
| NAME .....  |  |     |
| PLEASE PRINT CLEARLY  |  |     |
| ADDRESS .....   |  |     |
| CITY ..... STATE .....  |  |     |
| <input type="checkbox"/> Save shipping and C.O.D. charges! Check here if you send cash with order. (Cash, U.S. new postage stamps, money order, check.) Foreign countries no C.O.D. Add 20% to all prices quoted.   |  |     |



# RADIO-CRAFT

Incorporating

RADIO & TELEVISION

"RADIO'S GREATEST MAGAZINE"

## ONE WAR WE ARE STILL LOSING

By the Editor — HUGO GERNSBACK

. . . Every patriotic radio man should give this problem his serious attention . . .

It is surprising to note when people are speaking about the present global war that they think of it only as ONE war when, as a matter of fact, there are THREE wars which are being fought simultaneously. The present war, indeed, is a 3-dimensional war—the war on the surface of the earth; the war in the air; and the war below the surface, i.e., the submarine war. This is the first major war that this planet has ever had which can really be called a 3-dimensional war.

Up to comparatively recent months, the United Nations did not fare well in their war efforts, but it may be said that we have now obtained, as a whole, supremacy in the air; and we are beginning to get supremacy on the surface of the globe—that is, by land and by sea.

But the United Nations are still losing the third war—that is, the submarine war. Recent dispatches from England and from our own country indicate that the greatest menace at the present time is the submarine. Late in January, dispatches from London told that Germany is building 20 to 30 submarines a month, which is twice as fast as the United Nations have been able to sink them. It is also stated that Germany will have between 500 and 700 submarines fighting against the United Nations supply lines by the spring of this year. As the *New York Times* says, editorially: "We are still far from winning the war against the submarine. Our losses in this battle, in fact, imperil what we have managed to gain in every other battle."

What can be done about the menace? It is impossible to convoy every ship of the United Nations. Some ships cannot, in the very nature of things, be convoyed; and even if the ship is armed, it cannot hope to win a battle with a pack of submarines. A ship may, with luck, win a battle or escape when a single submarine is attacking, but when three or four or more lie in waiting, the contest usually becomes hopeless.

Even the convoys are not wholly safe, no matter how good the protection that the American and British Navies can give them. It takes too many destroyers, too many corvettes, and too many other defense means to protect a convoy 100% during its entire trip.

While accompanying airplanes and blimps are of great help to convoys during the daytime, they are almost helpless during the night when neither airplane nor observation balloon can see the submerged U-boat.

It would seem, therefore, that we must fall back to the *POSITIVE DETECTION* of the submarine, when it is still far enough away and therefore cannot do much damage. A submarine more than several miles away from a ship cannot launch its torpedoes with accuracy. Therefore, if a means can be found to accurately plot the course of the submarine from a ship in motion, the U-boat would lose much of its inherent advantage that it has now.

I believe that it is possible to improve upon the present detecting devices by means which have not been seriously employed up to now. We still use systems which were more or less in vogue in World War I—which, to be sure, have been improved upon—but the underlying principles are still the same. Most of the modern submarine detecting is done by sound wave which is reflected back to the ship that is making the observation. I believe that the sound system methods could be replaced by better means, because they do not carry far enough and there are other disadvantages. These disadvantages are the sea noises themselves. The motion of the waves, the noise of the ship's machinery, and even the passing of a whale or a school of fish is known to create doubts in the minds of the listening personnel as to what they are listening to. Then, too, it takes a highly trained personnel and long practice

in learning to distinguish the sounds and to interpret the reflected sound waves. Frequently it is impossible to distinguish where the sounds are coming from. If a submarine, for instance, is lying in shallow water, it is often difficult to know if the sounds are reflected by the submarine or by an overhanging shelf on the ocean floor.

I advocate the use of an *under-water radio short-wave means*; in other words, a purely radio means instead of the present-day sound systems. It is known that at certain frequencies it is possible to transmit radio waves underneath sea water. Inasmuch as the submarine is a metallic object of some size, the reflected wave could be caught and recorded by radio on the ship making the observations.

I can visualize such a system whereby the radio impulses are translated back into audio impulses, so that the listener could hear by ear exactly what was going on underneath the surface of the water. A binaural system could also be devised by sending several waves at the same or near-same frequencies together from two widely-separated points on the ship, and listening for them on an audio channel after the waves have been reflected.

It should even be possible to have two sets of radio waves leaving the ship at different angles and both striking the submarine simultaneously, where they would set up an interference pattern. This, when reflected back to the observer, could be used as a means to get accurate information as to how far the submarine was away and also at what angle it was, that is, whether it was deeply submerged or just cruising underneath the surface.

I appreciate that there are many problems connected with such a scheme and that it will not be possible to solve it overnight; but I do believe that it is possible to solve the submarine menace by using radio instrumentalities alone.

If by such radio means we can locate a submarine—say 5 or 10 or 50 miles away—and continuously draw a bead, so to speak, on the submarine, then the U-boat will no longer be a menace. The reason for this is simple. If the captain knows exactly where the submarine is located, most surface vessels can escape in time, because usually they can travel much faster on the surface than the submarine can travel submerged. Even a pack of submarines can be outwitted and outrun if we know exactly where they are. The submarine is dangerous only because so far we have had no satisfactory means to exactly tell where it is and where it lies in ambush.

It seems to me that it is up to the radio fraternity as a whole to do a lot of thinking and engage in research work on the problem. A good deal of experimental research remains to be done, but we are in the midst of a destructive and total war where our authorities in charge will be anxious to hear of any new and practical means that can be brought about to defeat the submarine.

It is suggested to all who read this and who have ideas on the subject, to communicate with the Navy Department in Washington. It should be remembered, however, that our authorities get hundreds of plans every week, and that before you do write, you should be convinced that you have something that is workable. Do not rely solely upon your own judgment. Even if you are expert in radio, seek advice from an authority in physics, too. A physics instructor, a professor of physics, can be of much help here. The problem by no means will be easy to solve, but if you are convinced that you have a plan, make it your business to see that it is presented as clearly as possible—with suitable drawings—so that it can be understood without too much guesswork by the Navy people.

# NIKOLA TESLA

FATHER OF WIRELESS

1857 - 1943

By HUGO GERNSBACK

ON January 7, 1943, there died in New York at the age of 86, Dr. Nikola Tesla, one of the world's outstanding electrical pioneers and inventors. Indeed, in the writer's opinion, Nikola Tesla ranked first as the world's greatest inventor.

Nikola Tesla was not only an inventor and a mathematician of a very high order, but he was also a great discoverer. In the opinion of many, including the present writer, Nikola Tesla had a greater inventive genius than even Edison.

Edison, indeed, discovered few of the things for which he is famous. Neither the electric light, nor the photograph, nor the motion picture were invented by Edison. This was the case with many other inventions credited to him. These three particular inventions had been made by others, but had been made practical by Edison, whose stature does not at all shrink on account of this. Most ideas are plentiful and cheap, and many of them are impractical until someone else comes along and labors in perfecting them.

Edison has deserved the world's everlasting gratitude for the monumental work which he did in perfecting impractical ideas of others, but Edison was not, strictly speaking, an inventor of new principles—certainly not in such a measure as the great discoveries of Nikola Tesla.

I am forced to make this rather sweeping

statement, because like so many other outstanding men, Nikola Tesla never reaped either the fame or the fortune that his illustrious work deserved.

Having been personally well acquainted with both Edison and Tesla, it was my privilege to observe both men closely and draw the conclusion as to why the name of Edison is known by every school child, and why the name of Tesla is known to only

reason was tremendous, and the result was inevitable.

Tesla also, unlike Edison, was never very much interested in human beings. He had practically no confidants; he never married and therefore had no family. Indeed, his only relative in the United States was a nephew. Tesla died as he lived—alone. On Thursday, January 7th, he was found dead (Continued on page 307)

comparatively few scientists, radio men, technicians and the like.

The answer lies in the one word—PERSONALITY. Edison always worked with a large staff. He surrounded himself with excellent people who, even at his earliest successes, saw to it that he obtained the publicity and fame which he deserved.

Tesla, to the contrary, was strictly by nature a "lone wolf." He made few friends, and even at the height of his fame never surrounded himself by men who could fight his battles and obtain for him the fame and fortune which certainly were his heritage.

Tesla liked to work in seclusion. Practically all of his life he was a hermit, having few close friends. He was at all times not too easily approached while his mind, unlike Edison's, did not run along practical lines.

Tesla invented because there was in him a constant urge to invent—Edison was interested only in the practical side of inventing. The difference between the two men for that

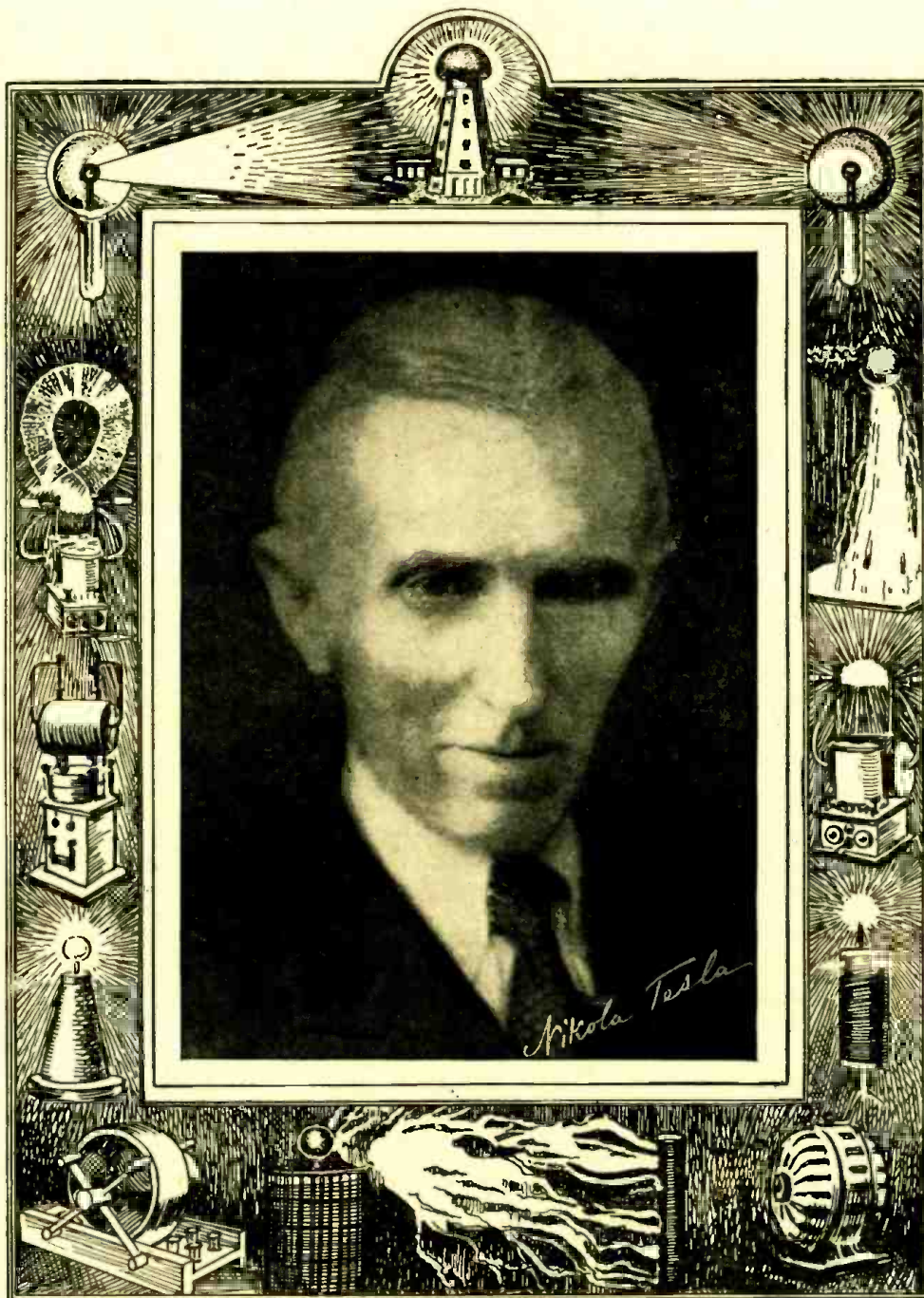

This photograph of Dr. Nikola Tesla was one of the last ones taken of the great inventor. He posed for it in 1936—on his eightieth birthday.—Photo by Sarony.

**T**HE editor of RADIO-CRAFT invited America's leading radio men and scientists to contribute their views on the outstanding achievements of Dr. Nikola Tesla. Their expressions follow:

**FROM THE PRESIDENT OF THE RADIO CORPORATION OF AMERICA**

COL. DAVID SARNOFF

**N**IKOLA TESLA'S achievements in electrical science are monuments that symbolize America as a land of freedom and opportunity. Fascinated by electricity, Tesla in the 80's naturally heard of Edison. He read that in America the Electrical Age was opening. To such a brilliant mind, a mind that dreamed of a world run by electricity, America was a powerful magnet. It attracted him across the Atlantic.

A dream came true and ambition was served when, soon after arrival on these shores, he went to work designing dynamos and motors in Edison's laboratory. American freedom and Tesla's spirit of independence led him as an original thinker to work free-lance. To him freedom and solitude were more important than money or a big laboratory. He dealt in new ideas—ideas, which to many others were fantastic. Throughout his life he kept on dreaming, and living more and more alone with his dreams.

Tesla, however, was not one whose dreams became his master. He mastered them, especially in the Nineties when he gave to the world the induction motor that made it possible for power transmission from Niagara to run the street cars in Syracuse, 160 miles away. He discovered the rotary magnetic field principle, invented the Tesla coil or transformer and many other electrical devices.

He pioneered in wireless. His novel ideas of setting the ether in vibration and then tuning for the waves put him on the frontier of wireless. Tesla's mind was a human dynamo that whirled to benefit mankind.

**FROM "THE FATHER OF RADIO"**

DR. LEE De FOREST, PH.D.; Sc.D.; D. ENG.

**N**IKOLA TESLA'S brilliant achievements, especially in the then new realm of high-frequency currents, were the guiding inspiration of my education in electrical engineering.

I aspired then to follow in his footsteps, for he convinced me that the next further development in the electrical art lay in wireless transmission, either of power, as for lighting purposes, or for signalling over large distances.

My personal debt therefore to Nikola Tesla is inexpressible.

The transcendent brilliance of his early career, as pioneer in polyphase currents and in the science of long-distance power transmission, places his name high among the few immortals, founders of the Electrical Age.

**FROM THE PRESIDENT OF THE INSTITUTE OF RADIO ENGINEERS**

ARTHUR VAN DYCK

**T**HE advance of science, and the advance of civilization itself, result from the contributions of many individuals to the integrated whole. The process is like putting together a jig-saw puzzle, which becomes more easy as the complete picture is approached, and is more difficult in the early stages where guiding signs are few.

Much credit is due to those individuals who conquer the early stages of a new science and show the way to those who follow. Such a one was Nikola Tesla, who showed the way through the early stages of alternating current applications. The "Tesla Coil" pointed the way to an understanding of high frequency phenomena.

His passing makes us pause to remember those early pathfinding struggles and triumphs, and that we owe a debt to Nikola Tesla for his contributions to the situation we now enjoy. The radio engineering profession for which I speak, acknowledges that debt and gives tribute to Tesla, one of its pioneers.

**FROM THE CHIEF SIGNAL OFFICER OF THE U. S. ARMY**

DAWSON OLMSTEAD, Major General

**I**T is with a deep sense of appreciation that I join, on behalf of the ARMY

SIGNAL CORPS, in this testimonial to one of the pioneers of electrical science, Nikola Tesla. As a young man, during the last years of the 19th century, Tesla made fundamental contributions to electrical engineering. In his later years, he lived to see his inventions incorporated into the very fabric of our civilization and play a vital part in the technology of modern war.

Tesla's place in history rests on his early discoveries in alternating currents. In the years since those discoveries were made, alternating currents have been extended from the low-frequency field of power engineering to the high frequency and ultra-high frequency field of signal communication, as well as to other electronic applications of utmost importance both in peace and war. A great proportion of the work of the Army Signal Corps is based upon the application of these alternating current phenomena. The armed forces of the United Nations have good cause to be grateful for Tesla's work and to pay tribute to his memory.

**FROM THE INVENTOR OF THE SUPERHETERODYNE AND FREQUENCY MODULATION**

MAJOR EDWIN H. ARMSTRONG, Sc.D.

**N**IKOLA TESLA'S inventions in the field of polyphase currents and the induction motor would alone perpetuate his fame. On this work, because of its early date I hardly feel able to comment; others are better qualified than I. But of his later work in the field of high frequency, high potential alternating currents, I do feel qualified to speak, for it was to exercise a most important effect on my career.

Who today can read a copy of "The Inventions, Researches and Writings of Nikola Tesla", published before the turn of the century, without being fascinated by the beauty of the experiments described and struck with admiration for Tesla's extraordinary insight into the nature of the phenomena with which he was dealing? Who now can realize the difficulties he must have had to overcome in those early days? But one can imagine the inspirational effect of the book 40 years ago on a boy about to decide to study the electrical art. Its effects was both profound and decisive.

And in the companion book, published in 1904, entitled "Experiments With Alternate Currents of High Potential and High Frequency", there is a remarkable chapter headed "The Transmission of Electric Energy Without Wires". Concealed, perhaps, by its too prophetic style (although a surprising number of the prophecies have come true), there is a complete appreciation of the use of radio in the broadcasting of information, with full emphasis on its social implications.

(Continued on page 310)

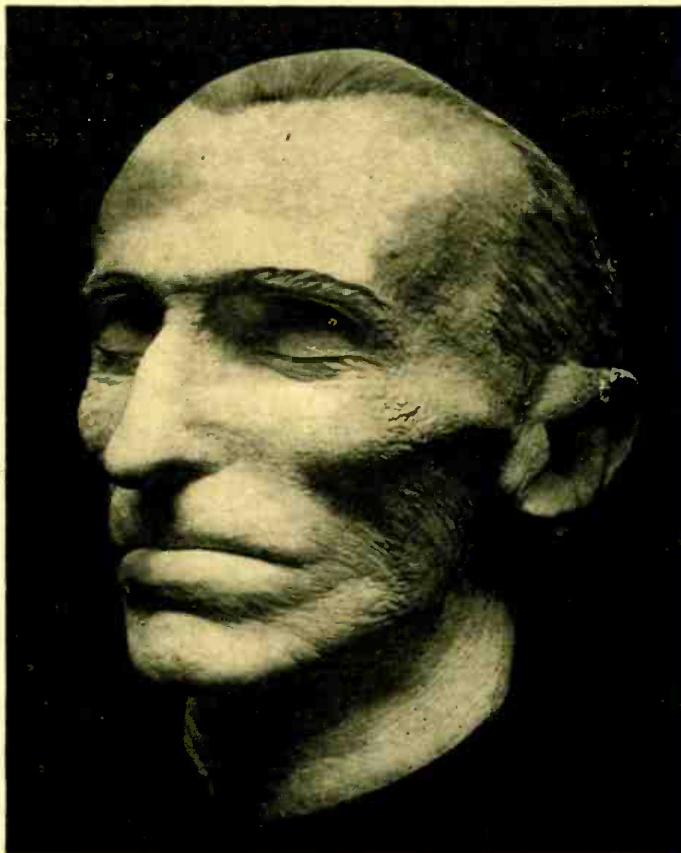

Before the burial of Nikola Tesla a death mask was ordered made by Hugo Gernsback, publisher of RADIO-CRAFT. This is a photograph of the death mask. The latter, made of plaster of paris, will soon be heavily metal plated. A suitable metal base with name plaque will then be added. Later Mr. Gernsback will offer it to the Metropolitan Museum of Arts to be preserved for posterity.

# POPULAR ELECTRONICS

By RAYMOND FRANCIS YATES

*Under the above heading we are beginning an important series of monthly articles on Electronics by Mr. Yates. The art of electronics encompasses Radio in all its phases, and then branches out into so many new fields that it becomes difficult to keep track of its triumphant march. In these articles, Mr. Yates will not only tell RADIO-CRAFT readers the whole amazing story of Electronics and all its almost incredible applications, but we asked Mr. Yates to keep in mind Experimental Electronics as well. Beginning with the second article in our March issue, this phase will be thoroughly covered. Mr. Yates is a well known writer and author. He was editor of "Popular Radio" in the early 20's. He is the author of over 15 scientific and Radio text books, including "Elementary Electronics," and his recent book on electronics "Super-Electricity."*

## PART I

**A**BOUT 70 years ago, so the story goes, a presumably bright young man employed as a clerk in the United States Patent Office went to his superior and offered his resignation because, as he thought, over 200,000 things had been patented and American genius had exhausted itself. He wanted a job with a future!

Curiously enough, we have many young men working in radio and electronics today who lack perspective, and what one great manufacturer calls "imagineering." True, we have come a long way since Johnstone

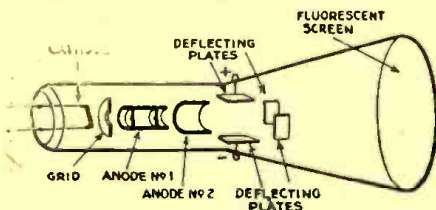

**CATHODE-RAY TUBE**  
(ELECTROSTATIC DEFLECTION)

Elementary diagram of a cathode-ray tube, one of the marvels of modern science, and a symbol of Electronics.

Stoney christened the electron and Fleming conducted his faltering experiments with the crude diode, but let us not mistake the mere beginning of things for the end. We are approaching a threshold leading to a fabulous age and this is no time to permit familiarity with the present to breed contempt for the future.

In our present contribution to this series of articles our purpose will be that of surveying the whole electronic field, its length, breadth and depth. Many of those working in or on the fringes of electronics have failed to take the measure of the craft. They do not really know what has happened to date, nor do they understand the tremendous significance of the field in which they labor.

We are now about ready for a summary of the tricks that can be done by the new family of electron tubes.

The following list is in no sense complete.

- |                                      |                        |
|--------------------------------------|------------------------|
| Acidity                              | Invisible light        |
| Alkalinity                           | Light intensity        |
| Area                                 | Linear speed           |
| Colors and hues                      | Pressure               |
| Counting                             | Revolutions per minute |
| Density                              | Ruptures and fractures |
| Distance                             | (metals)               |
| (for measuring)                      | Sound                  |
| Expansion or contraction             | Synchronism            |
| Frequency (electrical or mechanical) | Temperature            |
| Gas                                  | Transparency           |
| Humidity                             | Turbidity              |
|                                      | Visibility             |
|                                      | Weight                 |

Anyone failing to be impressed by this list should surely consult a psychiatrist. What are we going to do about it? Frankly, we don't know yet.

### THE CATHODE-RAY TUBE

But we still have adventure ahead. As yet we have to investigate that crowning invention, the cathode-ray tube. That awkward name may conjure up, to some people, all sorts of technical bogies, but we shall try to rob it of some of its terror. Really the device is quite simple, bared of the maze-like circuits that we find associated with it.

Let us picture a glass vessel about the size of a thermos bottle with two plates or electrodes sealed-in at each end, and connected to a vacuum pump. Connected to the plates or electrodes is a source of high-voltage electricity, say 20,000 or 30,000 volts. Inasmuch as about 35,000 volts are required to push a discharge, or spark, across an inch of space at ordinary atmospheric pressure, nothing will happen when we turn on the voltage in the air-filled tube. The electrons will refuse to budge, even with a 30,000-volt kick in the pants.

### ELECTRON BEAM

To make them move, we have to take away the barrier of air lying between the electrodes. The vacuum pump is set going. Down, down, down goes the air pressure, until a point is reached where a purely insensible amount of air is left in the glass

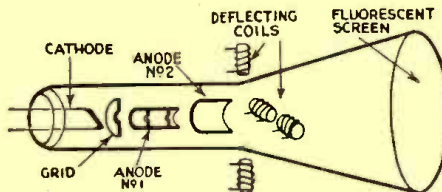

**CATHODE-RAY TUBE**  
(ELECTROMAGNETIC DEFLECTION)

Basic form of the cathode-ray tube with electromagnetic deflection coils, as used in some types of television tubes.

chamber. Now let us turn on the current. Zip, there she goes; a fine, fast-moving stream of pure electrons, electric current in the raw. The little air left in the tube will cause the electron stream to blaze a slightly luminescent path so that we may trace the course taken by the tiny particles.

If we carried the vacuum still higher, the electrons would still be there but we should not be able to see their effects. So down goes the physicist into his bag of tricks, and up he comes with a fluorescent paint, which, when placed on the inside of the tube, causes a bright spot to appear when the electron stream strikes it. Now we have something; but it is still incomplete.

### ELECTRON TRACE

Did we not say that electrons, being negatively charged particles, could be attracted by positive charges and repelled by negative ones? Sure enough. So let us place

two more metal plates in the tube, in such a way that the electron beam will have to pass between them. Then we place a positive charge on one plate, and a negative charge on the other. Now things turn out just as we had expected; the electron beam shifts, or is bent toward, the positive plate. The shift is noted on the fluorescent screen. The slightly inhibited action of the material used on this screen permits us to trace the beam's motion.

We know, (or should know, if we entertain any notion of keeping pace with this brave new world of ours), that an alternating current fluctuates; dashes back and forth in its circuit many times a second. First the impulse is negative, then positive, alternately. Connecting such a current to the little plates in the cathode-ray tube permits us to watch the dance of the current. Its picture would appear as a well-defined wave as the electron beam moves under its changing impulses. Should we use a direct current instead and connect that direct current to a microphone, the minute variations of the singing or talking voice would become plainly visible. They would not change any faster than the ability of the electron beam to follow. Electrons are practically inertialess mites.

With a pair of magnets added (electrons can be twisted out of their normal paths by the magnetic fields) we have before us the cathode-ray tube that will trace our television pictures for us.

So many things may be done by it that we are still trying to compile a list of them. Fortunately, it may be used at the end of a series of vacuum tubes. That permits us to amplify weak currents until they become able to influence the electron beam passing between the guiding plates. Then, if we replace our fluorescent screen with a photographic film, we are able to catch a permanent record of the dancing currents. Researchers at Harvard University amplify the currents generated by the human mind in its thinking and dreaming state, push them through a recording Einthoven galvanometer, and catch them in films. The

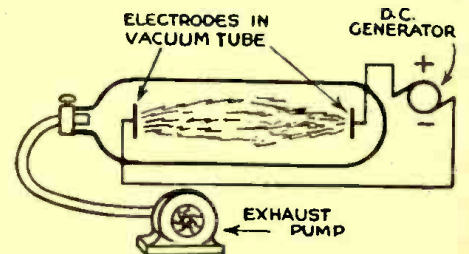

**ELEMENTARY ELECTRONIC GUN**

With air in the tube and 30,000 volts on the plates nothing would happen. But with the air removed, and the high potential applied, the electrons emitted show themselves in pretty sparks.

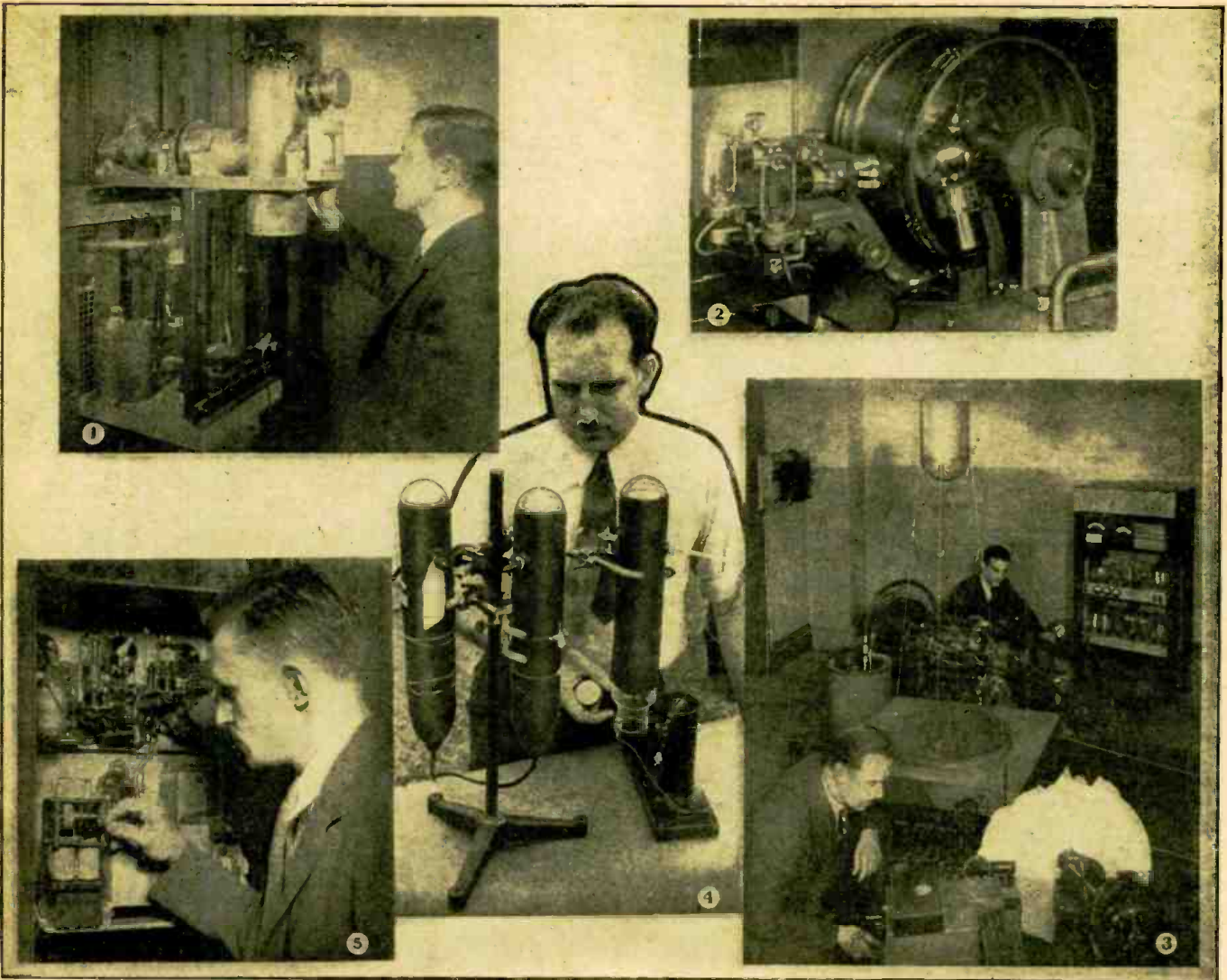

Illustrations of some of the thousands of electronic devices in use today. (1) The X-ray diffraction camera. (2) In certain telephone exchanges, it is necessary to transfer calls from dial to manual stations. If a subscriber on a dial exchange calls a number on a manual system, this robot converts the dial impulses into actual speech. (3) Studies of effects of earthquakes on structures. (4) D. E. Henry, Westinghouse engineer, adjusts the device which measures the strength of ultra-violet rays from the sun, in cloudy weather or fair. (5) This compact apparatus synchronizes widely separated broadcasting stations.

cathode-ray will turn this trick tomorrow or perhaps this evening.

**USES OF C-R TUBE**

Unless we have an imagination that reduces Jules Verne to the level of a half-wit, we shall never be able to forecast the future of the ray tube. The discovery of life in its essence may be only a matter of measuring and charting the rhythmic heat of electrical disturbances taking place within the body or organism. Through the use of this tube, we are just now beginning to learn things about sound that Helmholtz never dreamed. The following list notes some fields of science, art and industry that are already beginning to feel the effects of the application of the cathode-ray tube.

- |                       |                   |
|-----------------------|-------------------|
| Aeronautics           | Oil and mineral   |
| Ballistics            | prospecting       |
| Detection             | Physiology        |
| Electric current      | Power             |
| analysis              | Psychology        |
| Geophysics            | Radio             |
| Industrial processing | Sound             |
| Music                 | Teaching the deaf |

**CHALLENGE TO INGENUITY**

Just what the cathode ray is doing for  
**RADIO-CRAFT for FEBRUARY, 1943**

these fields of work and research forms a nice little bundle of knowledge for some prodigy to master. Ours is a vibrating world and here in the cathode-ray is the perfect analyzer of all vibrators and rhythms. "Oscillology" we shall probably be calling it when it reaches its stride, and heaven only knows the nature and breadth of its ultimate gifts to mankind.

It was not long after the discovery of the electron, late in the 19th century, that that modern miracle of miracles, the vacuum tube, was invented. When matter is heated, electrons are literally boiled out of it. A vacuum tube has a heated filament. An electrostatically charged plate carrying a positive or plus sign, sucks these electrons away from the filament as fast as they are produced, and succeeds in marshalling them into order for the creation of a sort of secondary current in an independent associated circuit.

Lee de Forest stuck a "grid" between the plate and the filament of the early tube, and thereby began to exercise a new degree of control over these electrons. We are just beginning to discover the importance of his work. We cannot pause for a full discussion of the mechanism of the advancement, but it promises to have startling social and economic repercussions.

**MAGNITUDES THAT STARTLE**

From this modest seed, the new art of electronics has grown. Perhaps we shall catch the significance of the invention of the vacuum tube when we say that it permits us for the first time to actually amplify energy—that is, to take a tiny source and to add local energy to it, and so increase it to large usable quantities. In a certain sense it is a sort of electrical lever that permits us to take a very small, insensible effect and so to magnify it that it becomes capable of controlling a locomotive or a rolling mill. The effect may be made highly accumulative by "cascading" the tubes so that the output of the first one is amplified by the second one, and so on.

Roughly, one tube has an amplifying factor or power of 10,000; it will release 10,000 times the voltage applied to the first grid. In the case of two tubes, it will be 10,000 x 10,000; in the case of three, it will be 10,000 x 10,000 x 10,000. Here is something new and exciting. Let's see what it means in practical effects.

We have a wonderful example of the power of the vacuum tube to amplify, in our home radio sets. A house-fly walking a distance of 12 inches up the wall dissipates enough energy to make a modern radio set  
*(Continued on following page)*

## POPULAR ELECTRONICS

(Continued from previous page)

to give an audible signal for at least ten years! Or if all the people in New York City talked at once, the energy converted into sound would not be sufficient to brew a cup of tea.

But what would happen if all of New York's 2,000,000 radio sets were turned on at once, all tuned to the same broadcaster? The voice of a single man would reach the stentorian heights of 13,000 horsepower!

Still that does not sufficiently portray the awesome ability to amplify. Let's try this: We know how small a single electron, is, and we have been told that three billion billion electrons per second are required by a 50-watt lamp. We have a vacuum tube today that will detect a flow of only six electrons per second. That should mean something even to the hard-to-shock reader of the Sunday supplements. It is just like saying that we can measure and amplify 1/100,000,000,000,000th of an ampere. We dissipate millions of times more energy than this every time we flick an eyelid in winking at a pretty girl. Compared to this sensitivity, we have the skin of an elephant, the eyes of a mole and the delicate touch of an enraged rhinoceros.

### SMALL START—BIG RESULT

And then there is the machine. We, crude and stupid as we are, are still more wondrously equipped than the electron, even though we are pretty heavily insulated from the really small effects around us. Light from a sodium flame has a wavelength so small that 509 trillion of the waves will pass a given point per second, but so long as this does not affect the price of butter or an admission ticket at the movies it is of small consequence indeed.

We shall come back to the vacuum tube; we shall have to, if we want to continue our modest education in robotry. For the moment, just let us keep in mind that here is a principle alarmingly new that is going to exercise an increasing effect on our lives whether we like it or not. When we pull the trigger of a shotgun, a small amount of muscular exertion instantly sets free a ripping, tearing force of much larger size. In a sense, a vacuum tube does the same thing, but its trigger may be a billionth of a watt or less, by far, than the flicking of a gnat's eyebrow.

In the growing vacuum-tube family, there is another member that will bear watching. It is called the grid-glow tube, and it comes in three styles; the cold cathode, the hot cathode, and the mercury cathode. This dry terminology hides a multitude of marvels. Taking the energy that may be drained from a single ounce of coal, and dividing it by the figure 20,000,000,000, gives a quotient which represents the amount of energy needed to pull this new electric trigger.

If that is not small enough for us we shall have to look for our excitement elsewhere. To this tube, one-fiftieth of a fly-power is the energy equivalent to the sound of a sock on the jaw. Sixty million times as much energy is needed to light a 50-watt bulb (coming back to the bulb-vs. tube method of comparison). All we need do is to throw the grid-glow tube into an unbalanced state of electrical excitement, to disturb a few of the poised electrons. Even just breathing, in the proximity of such a trigger, is sufficient to send it into an electrical tantrum. (If we are burglars, we had better watch out!)

We could go on and on with our list of vacuum and gaseous tubes. Several hundred highly specialized types bearing different trade names are now available. In

the General Electric "Greedo-Schenectady series," as Dr. Lee de Forest once jokingly called it, there is, besides the ordinary breed of radio tubes, the Plotron, Magnetron, Thyatron, Phanotron, FP-126, PJ-11, FP-54 and a host of others the invention of which would only confuse us, let alone the description.

We have stated that our breathing close to a grid-glow tube would set it off. We did not say, however, that our breathing

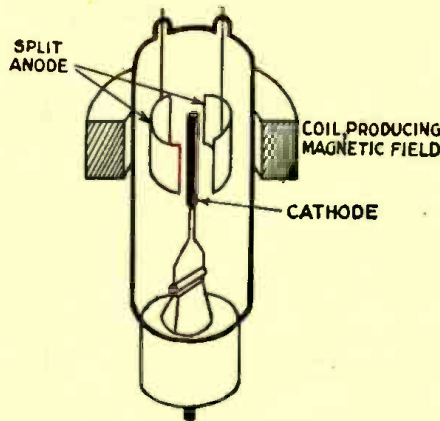

MAGNETRON

The magnetron is used to create oscillations. The external coil sets up a magnetic field which accelerates the electrons like a whirlpool. The two anodes (or plates) therefore yield a fluctuating current as the stream of electrons hits and misses them.

might throw a 10-horsepower motor into operation; which could happen. How? Well, that will require a little explaining. After all, a 10-horsepower motor is no mere propeller of baby carriages. We could not take a series of ordinary vacuum tubes cascaded electrically and breathe on the first one to initiate the movement of a progressively amplified effect that would be great enough

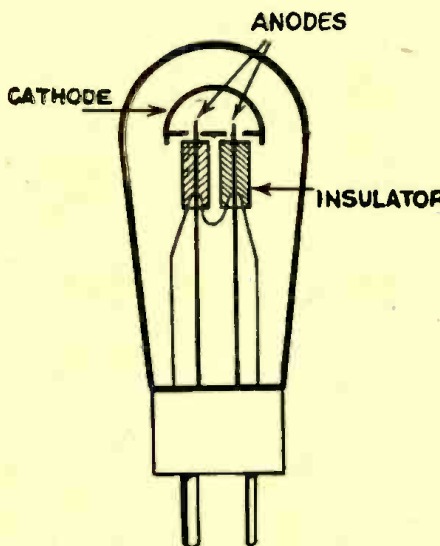

GASEOUS RECTIFIER  
(COLD-CATHODE TYPE)

This type of tube, once widely used as the "8H" rectifier, has the advantage that it does not require any energy for heating its cathode.

to squirt into the motor anything by a small and trivial percentage of the current needed to operate it. We can, however, use a single vacuum tube or grid-glow tube to close a relay, which would close the larger power circuit.

## PRESENT DAY USES

In the following listings we have a partial summation—and the word "partial" is emphasized—of the application of electronic devices made to date. Each application is followed by the code letters of the electronic device employed. "P.E." refers to photoelectric cell; "Amp." to vacuum tube amplifier; "OSC" to oscillator; "Rect." to rectifier, etc.

## COUNTING AND MEASURING

- Production lines (motors, automobiles, radios, refrigerators, etc.) (PE)
- Traffic in tunnels, on bridges, etc. (PE, Amp.)
- People passing, or entering theaters, etc. (PE)
- Animals, livestock, etc., in stockyard pens (PE)
- Recording beats of master clock (PE)
- Printing and engraving (PE)
- Tabulating statistics, quantities (PE)
- Measuring lamp, candle-power (PE)
- Timing races (PE)
- Integrating irregular areas by measuring light transmitted (PE)
- Astronomical measurements (PE)
- Color measurement (PE)
- Turbidity measurement (PE)
- Projectile velocities (PE)
- Calipering steel balls (PE)
- Control of sprays in lumber painting (PE)
- Boiler-gage-level alarms (PE)
- Counting printed items on cards, totalizing and analyzing (PE)
- Life tests of floor materials (PE)
- Automatic inspection of razor blades (PE)
- Measuring transmission of glass, goggles, etc. (PE)
- High-speed counting (Thyatron)
- Noise surveys (Amp.)
- Vibration measurement (Amp.)
- Comparing auto-tire noises (Amp.)
- Measuring luster in textiles (PE)
- Testing fuses (Cathode rays)

## INDUSTRIAL

- Reversing rollers in steel mills (PE)
- Motor-speed control (Amp.)
- Removal of soaking-pit covers (PE)
- Control of cut-off saws (PE)
- Calibration of watt-hour meters (PE)
- Calibration of frequency meters (PE)
- Control of cathode coating machine (Amp.)
- Regulation of clocks (Grid-glow)
- Furnace temperature control (PE)
- Limit switch control for motor travel (PE)
- Control of thickness of sinter beds (PE)
- Flue-gas control (PE)
- Elevator-door guards (PE)
- Filament winding machine control (Grid-glow)
- Testing welds (X-ray, Amp.)
- Humidity control (Amp., PE)
- Induction furnace (Osc.)
- Indicators in smoke stacks (PE)
- Detecting cracks and flaws (PE, Osc.)
- Opening doors for trucks (PE)
- Hydrogen ion concentration control (PE)
- Wire diameter recording (Osc.)
- Metal flotation control (PE)
- Moisture regulation (Osc.)
- Mine ventilation-door operation (PE)
- Photographic printing exposure (PE)
- Oil and ore prospecting (Osc., Amp.)
- Package-machine register control (PE)
- Welding current and timing control (Rect.)
- Operating valves, switches (PE)
- Safety protection of machines (PE)
- Analysis of card records (PE)
- Sludge-level control in sewage plants (PE)
- Alarm for smoke, water hardness, etc. (PE)
- Turning threads on pipe, conduit (PE)
- Paper break detection, manufacture presses (PE)
- Bag piling by conveyors (PE)
- Feeding to rubber-cutting table (PE)
- Automatic weighing of batches (PE)
- Pre-selective conveyor system (PE)
- Automatic folding, registering (PE)
- Synchronizing conveyors (PE Thyatron)
- Automatic titration (PE)
- Correcting for elevator-cable stretch (PE)
- Leveling elevators (PE, Osc.)
- Flagging tote-pans on conveyors (PE)
- Pulp control in paper mills (PE)
- Inspection of battery-caps for vents (PE)
- Detecting borers in timber (Amp.)
- Control of enamel thickness of wires (PE)
- Viscosity measurement and control (Amp.)
- Speed regulation of motors (Amp., Rect.)
- Voltage regulation (Amp., Rect.)
- Wire drawing control (Thyatron)
- Gyroscope stabilization (Thyatron)
- Thickness of rubber-sheet control (Osc.)
- Cheeking speed and synchronism (Stroboscope)
- Coating sandpaper (Rect.)
- Geophysical prospecting (Osc., Amp.)
- Detecting leaks in water mains (Amp.)

(Continued on page 316)

# CAPACITANCE BECOMES BOSS

By C. PETER JOHNSON, JR.

**T**HE beat-frequency meter is a new type of detecting and measuring device that has recently been introduced into industry. Its primary purpose is to detect small objects at large distances and to measure with extreme accuracy the dimensions of small articles.

In its ability to detect the presence of objects and to measure them, it far surpasses even the electric eye, and hence is one of the most promising of measuring devices. Indeed, it has proved so highly successful that it has been accepted throughout a large part of industry as a means of sorting objects and of controlling their manufacture.

The beat-frequency meter belongs to a class of radio-frequency instruments known as the tuned-circuit or capacitance-operated group. The fundamental operation of any tuned-circuit detector is based on the effect of detuning being caused by a small amount of capacity being introduced into it.

If an external body is brought near the tuned or resonant circuit, the capacitance of the circuit is increased. As a result, the circuit is detuned and a great change in its electric properties takes place. The impedance, or effective resistance, of the resonant circuit drops from an extremely high value to a very low one, and the voltage and power developed by the tuned circuit are consequently greatly decreased.

Almost any one of the changes in the circuit properties can be used as a means of detecting the outside body.

If the tuned circuit is in the plate circuit of a radio-frequency oscillator, the rise in plate current accompanying the loss of impedance of the tuned circuit when it is detuned can be made to operate a relay. Or an amplifier can be operated by the voltage developed across the resonant circuit in the plate circuit of the oscillator. The decrease in resonant-circuit voltage accompanying detuning decreases the bias on the amplifier and thus increases its plate current, which can then operate a relay.

## HOW IT OPERATES

The beat-frequency meter contains two radio-frequency oscillators which are tuned almost exactly to the same frequency. The outputs of the two oscillators are mixed in a frequency converter vacuum tube, and the frequency difference, or *beat frequency*, of the two oscillators, emerges.

After passing through a tuned circuit, the beat-frequency current is used to bias another vacuum tube, the plate current of which passes through a relay.

A small metal disk or piece of wire is attached to the tuned circuit of one of the oscillators. When an external body approaches the disk or piece of wire, capacity is introduced into the circuit of the oscillator, and the oscillator frequency decreases. Since the two oscillators were originally tuned almost exactly to the same frequency, there is a large variation in the beat frequency, or frequency difference, of the oscillators.

The tuned circuit through which the beat frequency passes, is no longer tuned to the beat frequency, and the voltage de-

veloped across the resonant circuit, which biases the amplifier, decreases. As a result, the amplifier plate current rises and operates a relay. Fig. 2 shows what happens to the outputs of the two oscillators.

## LIMITS OF SENSITIVITY

The meter is an exceedingly sensitive instrument. Theoretically, the only limit to

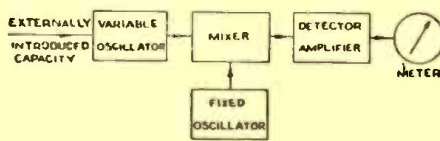

Fig. 1  
Block diagram for a typical beat-frequency meter.

its sensitivity is the stability of the oscillators; and by the use of quartz crystals and temperature-compensating devices, this stability can be increased almost indefinitely. In practice, moreover, the meter is far more sensitive than is necessary for its applications. For example, it is quite easy to make one so sensitive that a slight motion of the hand can be detected at forty feet.

Instruments have been made that can measure and sort articles far better than the most accurate mechanical tool. Further-

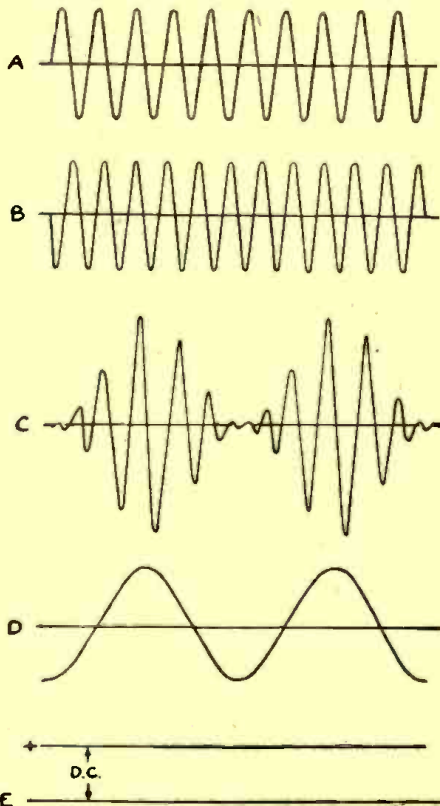

Fig. 2  
(a) The output of the fixed-frequency oscillator. (b) The output of the variable-frequency oscillator. (c) The mixed wave of the two oscillators produced in the frequency converter. (d) The voltage developed across the beat-frequency tuned circuit. (e) The final output after detection and amplification.

more, the sorting is a very rapid one. Within a fraction of a second the beat-frequency meter will register the deviation of an object from standard dimensions.

Practically the only fault accompanying its many uses is that it is *sometimes too sensitive*, too easily influenced, by small variations.

However, its widespread adoption in industry shows that this fault is of minor importance.

## USES OF THE METER

As one would suspect because of the marvelous properties of the beat-frequency meter, the instrument has a myriad of uses.

However, two of its most important applications are sorting small objects and controlling their manufacture. (Although it is readily adapted to controlling the manufacture of articles, purely mechanical limitations in the producing machine prevent the complete realization of the tremendous accuracy of the meter.)

If a very small clearance is required between two kinds of articles, the beat-frequency meter can sort the two kinds of objects and match those that will best fit together. Furthermore, the sorting ability of the instrument is so rapid that even objects having large tolerances of dimensions can be profitably sorted.

If an endless belt carrying small articles is run beneath the meter, the objects are rapidly sorted into groups of articles having the same dimensions, and at the same time articles which are undersize or oversize are rejected.

Similarly it is frequently used for counting the number of articles passing off an assembly line. Its great advantages over the electric eye for this use are, that the objects do not have to follow a set path, and can be counted and sorted at one and the same time.

The beat-frequency meter is also used for many other purposes. In stores it is frequently used for starting displays to attract the customers' attention, for when a person walks near, a relay can be made to close and operate a demonstration. Furthermore, it is frequently used for detecting unauthorized entry into a building because it can easily detect the presence of a person. The beat-frequency meter cannot be evaded or put out of order by an intruder because it can be completely concealed, even in a wall, and cannot be approached from any direction without being operated.

Because the beat-frequency meter is non-directional, it can count objects passing in all directions. Its ultra-sensitivity to the human body makes it useful for store displays, burglar detection, and, in general, for counting people passing it, even if other large objects are moving around. The beat-frequency detector could thus be readily used in an industrial plant to count personnel and to detect any intrusion.

The cost of the instrument is, unfortunately, extremely high. However, the reason for the great cost is not the cost of

(Continued on page 299)

# AIR RAID ALARMS BY ELECTRONIC MEANS

By WERNER MULLER

*A summary of present practice in the use of remote signaling devices in air raid alarms and blackout controls including electronic applications.*

**B**EING a keen observer and always on the lookout for new ways of applying electronics to new uses, the idea of turning on and off any form of signal and lights by the medium of radio became quite obvious. It was in the spring of 1941 that the difficulties of blackouts during air-raids in London were discussed in one of the New York papers. Since then other important issues have crept upon us, and we are faced with the same problems that London had to face.

A number of devices have appeared on the market that cover our needs more or less, but as yet still another method is needed to give greater performance and assurance of operation.

After a rather complete survey I became vitally interested in the possibility of improving the present suggested methods and obtaining instantaneous signal control for blackouts.

Since blackout control is primarily to be used during war time, it follows that a system of utter reliability has to be evolved. Furthermore, a thorough study of power distribution in the city limits had to be made.

It was my good fortune to be able to discuss the problems with some of the leading officials in the city of New York. Much data and information was thus obtained. After several conferences the problem of turning street lights on and off was considered a rather complicated affair since the power-lines supplying the lights supplied other apparatus and equipment that must be kept running at all times.

This fact automatically necessitated considering a more practical method of control than using manual means. Electronic means seemed to be the answer but *what form of control* was also an important question.

## TYPES OF CONTROLS

The most common form and the simplest on the surface of the problem, seemed to be a radio type of control. This would chiefly consist of a simple receiver and a radio sensitive relay.

This radio sensitive relay in turn controls a secondary relay that turns the power off. Of course this device can also be used for turning off electric signs, house lights and a number of other functions. The operation of the unit is simple in that it relies on any

existing radio signal being transmitted from a radio station. The receiver receiving the radio signal rectifies this signal and produces a D.C. voltage that operates the relay. When the radio station stops emitting its carrier, the D.C. current or voltage in the receiver stops, and the relay completes its function by either closing or opening its controlled circuit. This form of system is rather limited in its use, as follows:

1. Once the lights are turned out by the device they must be reset manually.
2. Sensitivity of the receiver must be kept low, that is, it must be highly squelched so that static and other forms of interferences will not cause disturbances in the device which may give relay chatter.
3. The device is subject also to interference from heterodyne action which may take place in the neighborhood. For example a powerful radio receiver of the super-heterodyne type may emit a radio wave (by its oscillatory circuit) sufficiently strong enough to prevent the operation of the device (if the oscillatory frequency should accidentally be tuned to the blackout device's receiving frequency). This can be partially remedied by using a modulated signal for operating the relay in the receiver.
4. Due to the fact that it has to be reset manually, it is subject to sabotage, tampering and human error.

Having established these four facts covering the simplest forms of blackout device, we are sure that it is not a universal system.

Next in our mind comes the blackout device similar to the one previously described but instead of being controlled by a CV carrier through the air, this device obtains its control by radio frequency waves transmitted over the power lines. This system, which also can be very fundamental, consists of a simple receiver and a radio sensitive relay controlling a secondary relay is operated by a number of radio impulses or a tone-modulated radio-frequency carrier super-imposed on the power lines by a transmitter situated in the powerhouse sub-stations.

In this device the operation can be of two types; one using a cold cathode type of receiver, the other a conventional radio receiver operating on any convenient frequency, preferably low frequency, using conventional tubes.

With the cold cathode tube type of re-

ceiver modulated or unmodulated frequency pulses giving relay control can be used, but considerable power from the transmitter is required to overcome the difficulties presented by the power lines (variable loads, etc.). Using the carrier radio frequency receiver, the transmitted power can be considerably less, since the sensitivity of the receiver can be of a higher order.

Both types of devices have their shortcomings, those of the cold cathode type being:

1. High transmitter power.
2. Subject to static disturbances.
3. Permits only lights to be turned off.
4. Subject to sabotage and errors.

The carrier receiver type control device,

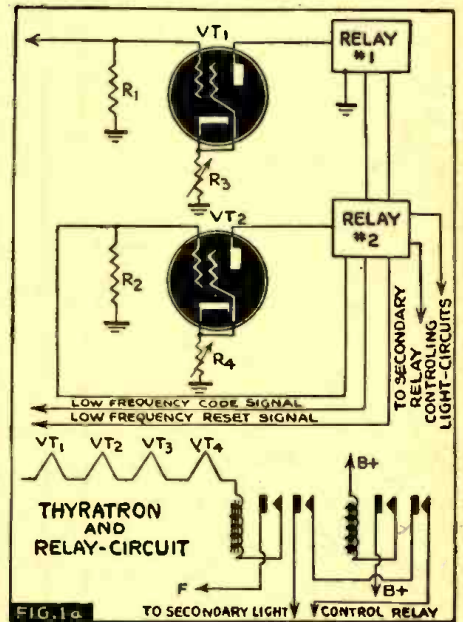

FIG. 1a  
Typical relay circuit, thyatron-controlled, initiated by remote signaling. No values of components nor statement operating conditions are given, as this combination is not to be considered for construction. It is for reference only, in connection with the text.

even though it requires less power, is subject to:

1. Static discharge interferences.
2. No protection in case of failure.
3. Subject to sabotage.
4. In case of pulse operation any independent source of pulses will operate the device.

Aside from the aforementioned difficulties, one of the biggest problems of carrier control via power lines lies in the power lines themselves. Aside from the variety of loads which may upset carrier operation, the fact that several large areas throughout the country are supplied with either A.C. or D.C., presents, perhaps, one of the biggest difficulties. That is, carriers transmitted over power lines carrying alternating current is fairly simple, but carrier transmission over power lines supplying direct current is a very difficult problem, and its ultimate solution lies in the future. Thus it can be seen that carrier control of lighting

Block diagram of a typical system of R.F. controlled lighting system. This diagram is for reference purposes only, and no details of elements in any of the stages is available. Those familiar with the art are well acquainted with the make-up of the combinations possible. It is not intended that any of these various devices be considered for construction.

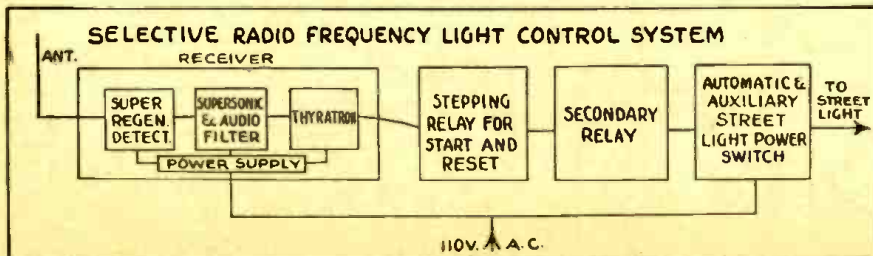



systems is useful only when additional devices are incorporated in the receiver.

The three systems roughly described are the simplest forms, and having analyzed their shortcomings, we must now overcome each one of the objections or failures. I shall list numerically the combined faults

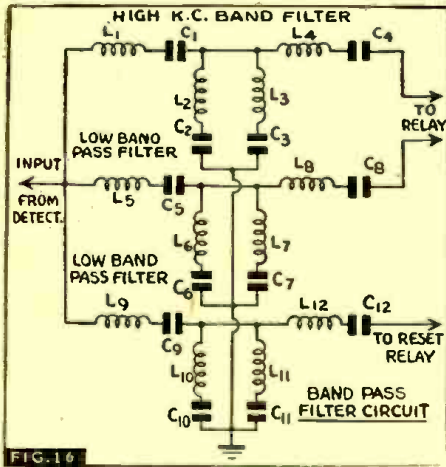

of the systems, and then will individually elucidate the manner in which they can be properly overcome; finally evolving a device which is foolproof, basically sound, and whose cost is reasonable compared with its all around performance. Furthermore, this device is such as to enable its use in the future as well as at present, since it does not necessarily have to be restricted to war-time application only.

To group the derived results, the performance point comes first.

1. The device must be foolproof and sabotage-proof.
2. Must be secret selective.
3. Must be compact in size.

From the standpoint of cost, the device must be so designed as to permit its manufacture and distribution at the lowest possible price, without sacrificing any of the foregoing features.

The above two demands as outlined can be very well covered, and a complete description will be given of just such a system; a system that is secret selective for turning devices on and off, and that is as foolproof and troubleproof as can possibly be made.

Power for operation of the unit is of course derived from the power lines, and since the unit must be in operation 24 hours a day, protective devices have been installed, consisting of two relays. The function of the relays is to break the controlled power line circuit in case of a breakdown or a tube blowout within the device.

Since all component circuits and parts are of the best quality, little trouble is to be expected. The protective relays act in such a manner that if a filament burns out, the associated relay opens, opening the controlled power line relay also. This results in shutting off the street lights or electric signs. Or if the B-supply "shorts," the corresponding relay will react on the controlled power line relay in such a manner as to shut off the power line (opening the line circuit).

The other main requirement, of course, is a transmitting station. This transmitter should be so located as to give adequate

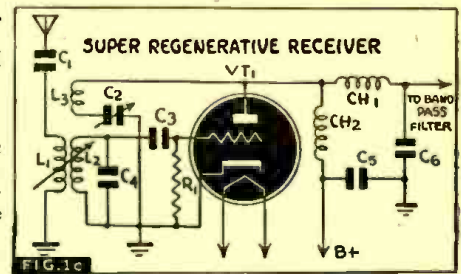

coverage. This is available in those communities which have municipal transmitters that operate in the high-frequency band (25 to 60 megacycles). The signal to be transmitted consists of a carrier, modulated by a series of 3 pulses of different frequencies. These frequencies can be any convenient ones between 50 to 30,000 cycles. For example, 7,000, 11,000 and 13,000 cycles. The function of these frequencies is as follows:

1. One frequency is used for turning a circuit off, in code.
2. One frequency is used for turning a circuit on, in code.
3. One frequency is used for clearing relay circuits, in code.

These pulse signals can be sent by automatic means, or manually. They can be tied-in with any general alarm system from any observation point.

If additional secrecy is required for the settings by code, it can be done, as outlined later.

RECEIVER LAYOUT

The receiver proper consists of three  
(Continued on page 319)

ELECTRONIC PHONO PICKUP

By LESLIE GOULD

HERE is something new in the way of phonograph pickups for the constructor and experimenter to work on that is different and interesting.

It uses as the tone arm, a bar of Lucite, the transparent plastic which conducts

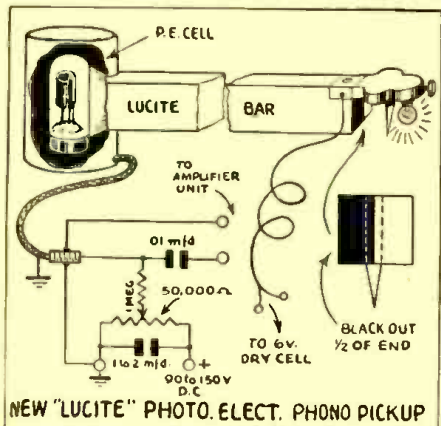

light along the length axis and does not radiate it at right angles.

The pickup head in which the stylus and light is mounted, is made of an old crystal pickup holder, or something similar to it.

On it is mounted a pilot-light type of lamp, of the 2.5 or 6.3 volt series, mounted in such manner that its beams must pass across the stylus to enter the end of the lucite bar. Note that the end of the bar on which the stylus is mounted is half blacked-out, so that the motion back-and-forth of

the stylus cuts the rays of light from the pilot bulb in such a way as to give a pulsating wave, which of course can be picked up by the photoelectric cell and amplified.

The pulsating wave is conducted through the lucite bar and strikes the photoelectric cell which is mounted (and shielded) at the support end (or back end) of the pickup arm. The photoelectric cell can be of any type—caesium; selenium-on-iron; etc.—which responds to ordinary electric light. The band of light frequencies of ordinary light, by the way, are similar to those of

human vision, which on the Angstrom scale runs from about 4000 to 8000 Angstrom units. This information is given so that the proper photoelectric cell may be selected, or different ones tried out.

In all cases, the cell should be mounted so that the concave plate, or the "receiving" plate, faces the beam of light.

If an iron selenide type cell is used, the input circuit shown is not needed, but a suitable matching transformer is.

A lot of experimenting was done with  
(Continued on page 299)

The lucite bar phono pickup as built by Mr. Gould, shown in actual use. Note the neat, trim appearance of the assembly; partly achieved by the shielding of the photoelectric cell.



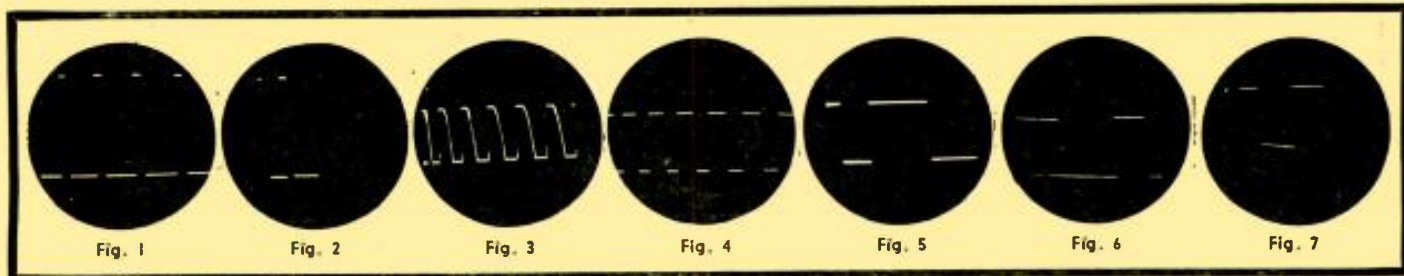

Actual photographs of square wave waveforms on the oscilloscope. Reading from left to right the figures show: (1) Single 50-cycle square wave. (2) Single 200-cycle square wave. (3) Single 1000-cycle square wave. (4) A series of 4000-cycle square waves, (5) A series of 50,000-cycle square waves. (6) 200-cycle pulse generated by the instrument. (7) 1000-cycle pulse generated by the instrument, and (8) 4000-cycle pulse generated by the instrument.

# A VERSATILE SQUARE WAVE AND PULSE GENERATOR

By WARREN MILLER

## PART II

In the first article a description of the actual apparatus for generating square waves was fully described.

To understand the following it is essential that the reader be fully acquainted with the preceding part.

### PANEL CONTROLS

If one inspects the front panel the following is to be observed. At the bottom center is the frequency-change switch SW2. To right of that same is the fine frequency control R4. Above SW2 in the center is the output-control, R11. To the right of this control is the pulse width-control, R6.

In laying out the panel arrangement no particular scheme was followed, and any other layout will do. If the builder desires to rearrange the location of the controls for better symmetry, he may do so.

The power switch is at the left. The output terminals are in the left upper corner. Only one set of binding posts is shown.

namely B2. Binding posts B1, are not used, but should be installed and wired, as per diagram. These posts, with R1 and C7, are used for synchronizing with any standard signal source within the range of the generator, if it should be so desired. In the model constructed it was left out, since the unit was stable enough in its operation.

### FREQUENCY COVERAGE

The following frequencies are covered with SW2 and R4, with R6 in the "off" position, where it must be kept.

- With SW2 in Position 1, R4 at minimum,  $f = 22$  cycles  
R4 at maximum,  $f = 130$  cycles
- Position 2, R4 at minimum,  $f = 60$  cycles  
R4 at maximum,  $f = 400$  cycles
- Position 3, R4 at minimum,  $f = 100$  cycles  
R4 at maximum,  $f = 560$  cycles
- Position 4, R4 at minimum,  $f = 550$  cycles  
R4 at maximum,  $f = 3250$  cycles

- Position 5, R4 at min.,  $f = 3250$  cycles  
R4 at max.,  $f = 10,600$  cycles
- Position 6, R4 at min.,  $f = 10,600$  cycles  
R4 at max.,  $f = 22,000$  cycles
- Position 7, R4 at min.,  $f = 22,000$  cycles  
R4 at max.,  $f = 100,000$  cycles

As can be seen the range is from about 25 cycles to well over 100 kc. Distortion, as actually measured, is very low; that is, is noticeable only below 50 cycles, and above 40 kc. In-between ranges are uniform for all practical purposes.

Fig. 1 shows a single 50 cycle square wave. Fig. 2 shows a single 200 cycle square wave. Fig. 3 shows a single 1000 cycle square wave. Fig. 4 shows a series of 4000 cycle square waves. Fig. 5 shows a series of 50,000 cycle square waves.

In the last case distortion can be seen; but this is due entirely to the amplifier of the oscilloscope not being able to reproduce the waveform properly. If the signal were fed directly to the deflecting plates, the picture of a perfect square wave would have resulted. Figure 6, 7, 8 represent pulses as generated by the instrument, the pulses being respectively 200, 1000 and 4000 cycles.

### PULSE GENERATION

In case it is desired to produce or generate pulses, the following procedure is recommended:

Select the desired square-wave frequency, and then adjust R6 until the pulse width is of the desired nature. If the generator is synchronized to a standard frequency, of say 400 cycles, then the observed square-wave of 400 cycles (as seen on the oscilloscope of course), can be changed slowly by varying R6.

As the control is increased, the 400 cycle pulse will become narrower and narrower, as can be seen in the photographs. The chief interest from the operating standpoint, is the width of this pulse, when it starts, that is, from its broadest point to its narrowest point. The top of the pulse is called the duration of the pulse, and is determined mathematically.

In this generator the time can be varied from a few milliseconds down to 4 microseconds or better, depending on the frequency used and the width of the pulse. As can be observed, the rise and the fall (called

(Continued on page 315)

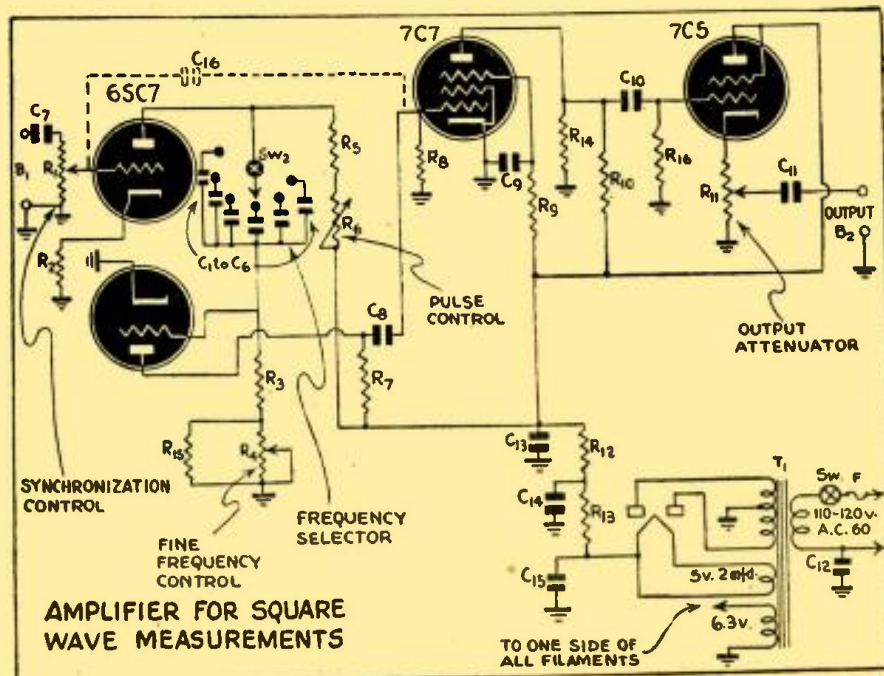

# ELECTRONICS EXPLODES RIVETS AND GLUES PLYWOOD

**T**HROUGH development work done by RCA and DuPont engineers, ordinary rivets, such as are used in airplane work, are set 15 to 20 per minute as compared to the old way, which had a top speed of 1 or 2 a minute.

The story on this goes back a little way to the time when DuPont developed the idea of having the rivet hollow in the shank end, which is the end "butted" by the helper in the riveting operation.

This little hollow was provided in order that a small charge of explosive might be placed therein. Then on the job, one man (not two) sets the rivet by igniting the charge.

The charge when ignited, "explodes," and expands the metal of the shank against the metal it is to fasten against, and holds far more securely than by the "butted" method, which sometimes weakens the rivet by thinning out the metal.

The gadget used to ignite the charge looked something like a soldering iron and was just about as awkward and as time-wasting to handle. It could not be too hot or it would ignite prematurely. If it were too cool, the operator had to wait for it to warm up to proper temperature.

This is where the electronics part comes in. It was known that radio-frequency currents (at certain frequencies) can induce heat in metals (and in dielectrics as well), and it was conjectured that if a steady controllable source of such heat could be used it would facilitate the work, simplify the operation, and increase the production.

So the engineers cooperated and worked out the device shown in the illustration.

They worked out a compact portable source of R.F. currents which could be placed on a bench or inside an enclosure, with convenient lengths of cable for the output coils. They redesigned the igniting tool so that it now transfers the maximum of energy in controllable amounts and at the point where needed.

So all in all they improved a production tool, speeded up production, and saved labor.

Besides saving a helper, the rivets can be placed in advance, and held by scotch tape, which does not interfere with the action of the R.F. currents.

## ELECTRONICS MOLDS PLYWOOD

Another use for R.F. currents is in the molding of plywood such as is used in aircraft and boats of all sorts. Instead of using glue as heretofore, *thermo-plastics* (bakelite and other synthetic resins which set when hot) are used as the bonding agent between the plies.

Here again a generator of R.F. currents is used, being applied at the time of pressing, supplying the needed heat without burning the wood or making an awkward production arrangement. The arrow in the photo points to the general location of the

The electronic exploder at work. The sketch in the upper right-hand corner shows the hollow rivet with explosive charge, and its appearance after the charge has been detonated by the electronic riveter. The electronic riveter is really a heater, the heat coming from the R.F. currents generated in the device on the bench.

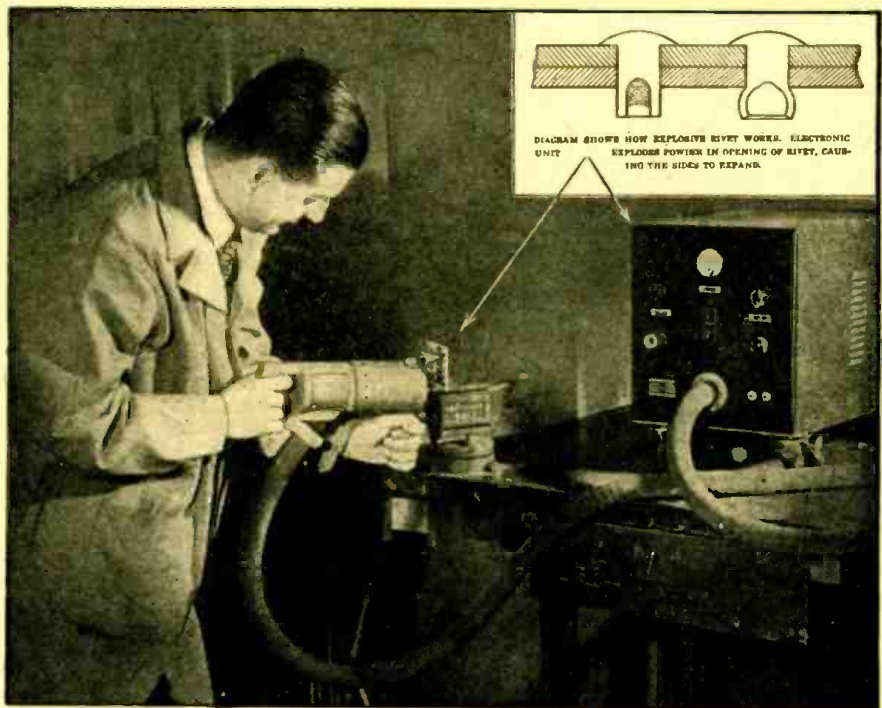
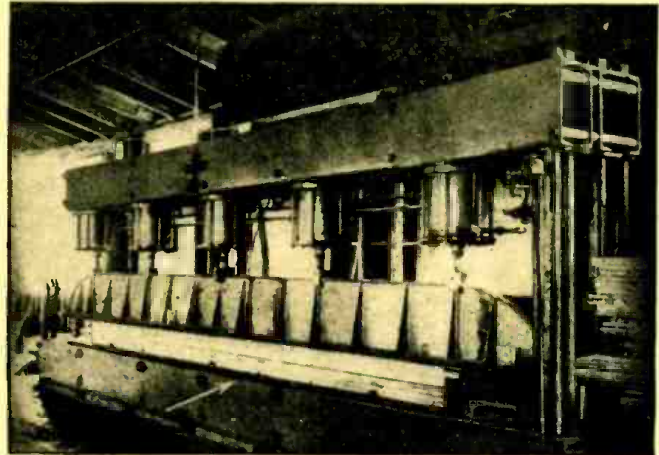

DIAGRAM SHOWS HOW EXPLODES RIVET WORKS. ELECTRONIC UNIT EXPLODES POWERS IN OPENING OF RIVET, CAUSING THE SIDES TO EXPAND.

The arrow indicates the general location (below the boards and in the base of the press), of the electronic heater which provides the heat necessary for the thermo-plastic binder to set. This huge press is making plywood out of the 8 original boards.

coils beneath and behind the boards as they are pressed.

It can be seen what a tremendous help this is in the manufacture of airplane propellers (which have been found to have greater tensile strength than their aluminum prototypes), and airplane fuselage.

One manufacturer uses a 10-Mc. frequency generator to replace the old steam process or the slow-baking process.

Wooden masts, hulls, bulkheads—all these can now be made this faster, cheaper, way, with great reduction in weight and an increase in strength.

The possibilities are tremendous and will no doubt have widespread adaptation.

The engineers call this form of heating of non-conductive materials, "dielectric" heating, as contrasted to the heating of metallic conductors, which is called "induction" heating.

It is the dielectric type of heating of course which is used in the processes described above, much like the familiar diathermy machines which generate deep heat in the body tissues because of "dielectric losses."

It has been suggested by an inventive mind to call this field of furnishing heat by radio-frequency currents, *Radiothermics*.

It sounds good, and ought to catch on.

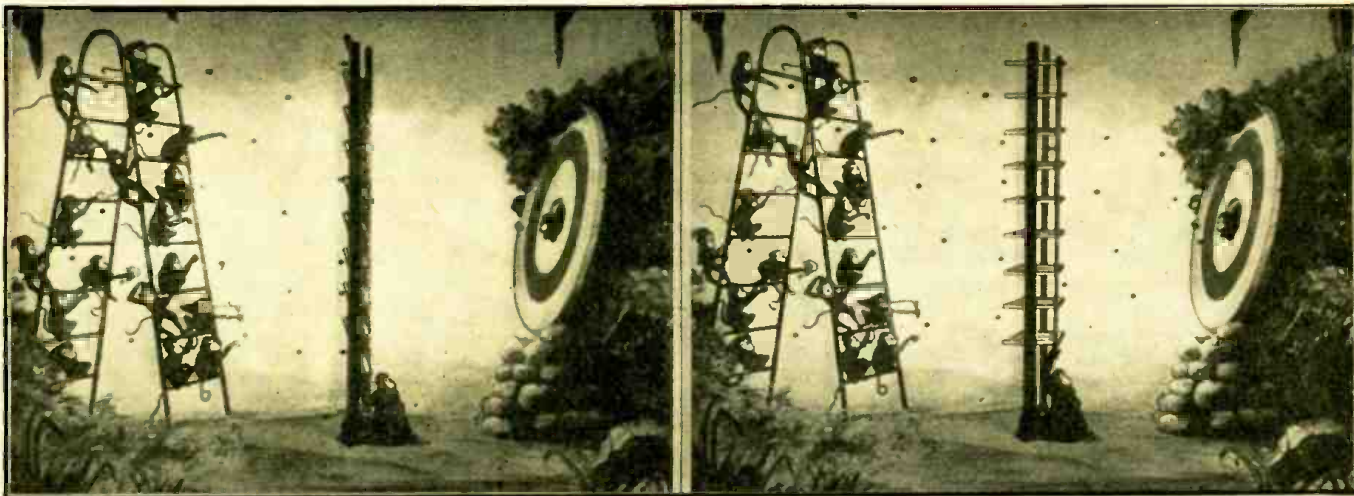

Sample "stills" from the Western Electric short movie on electrons in a vacuum tube, and how vacuum tubes work. The photo on the left illustrates repulsion of electrons by the grid when the grid is negative. The photo on the right shows the electrons reaching the plate when the grid goes positive.

## MODERN ALADDIN'S LAMP

**I**N a new motion picture, available from Western Electric Company in one-reel and two-reel versions, is told the story of the development, manufacture and uses of modern vacuum tubes.

One of the most interesting parts of the picture, to radio men at least, is the clever

and lucid way in which the action of the electrons in a vacuum tube is told.

In one example, a group of monkeys mounted on a ladder (the filament or cathode), are shown tossing coconuts at another monkey, who has his head sticking out of a target (the plate), through a shutter

arrangement (the grid) opened and closed by a third monkey.

The monkeys throwing the coconuts are throwing them all the time, but only when the shutter is opened do they manage to toss a few through that go on to the target.

This is about as close an analogy as can be made of the actual electronic process that goes on inside of a vacuum tube. Pictured in the film is still another one, showing a traffic cop as the grid, who alternately stops and passes the traffic of electrons to flow to the plate.

In such clever ways the usual abstruse and tedious technical and theoretical explanations are avoided and basic ideas are clarified and impressed upon the minds of the viewers. Continuing the motion picture tells the story of the development of the vacuum tube from the crude days of Edison and DeForest, to the modern powerful and efficient tubes of today, as used in radio, in long-distance telephony, public-address systems, sound motion pictures, and in the modern electric phonograph.

Then the scene swings over to the tube shop, where the tubes are made. Here is shown how precision workmanship is required to make broadcast and telephone repeater tubes.

The camera moves from one intricate operation to another, showing how the skilled workmen and modern machines, transform the spools of wire and the rods of glass into those useful things we call radio and electronic tubes.

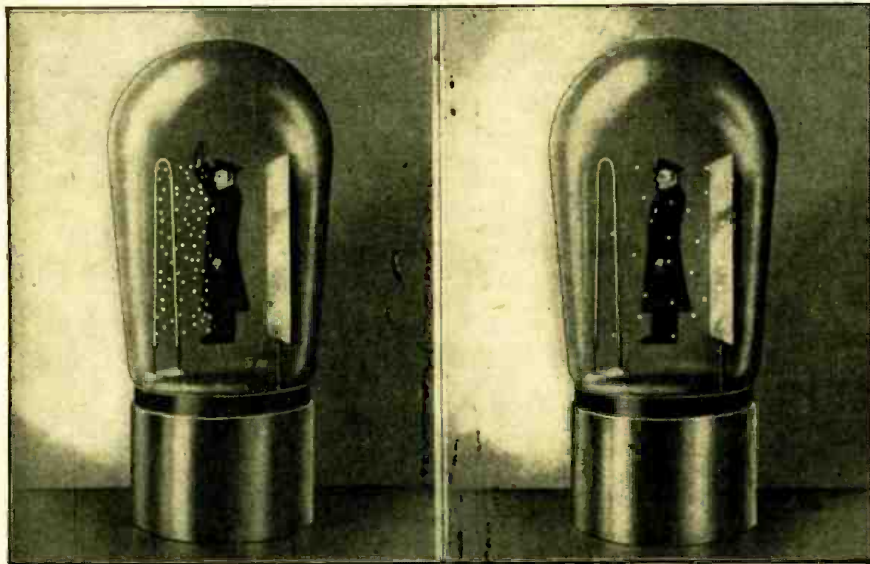

Another set of stills from the movie on electronic action. In the photo on the left the cop represents the grid when it is negative, repelling the electrons coming from the filament. On the right he permits the traffic of electrons to pass, thus indicating the grid when it goes positive.

## FUTURE OF ELECTRONIC TUBES

**T**HE electronic tube, used mostly for radio until a few years ago, is now finding increased application in war plants throughout the nation. This was pointed out in a talk to the American Marketing Association, last month, in New York City, by Dr. W. R. G. Baker, General Electric vice-president in charge of the company's Radio, Television and Electronics department.

Electronic motor control, for example, boosts the war production of machine tools by as much as 50 per cent, he explained. Electronic control for resistance welding is speeding the production of aluminum planes. Electronic rectifiers are helping to produce

millions of tons of aluminum and magnesium. Electronic control devices are helping to tinsplate 50 per cent faster and with a saving of one-third of the precious tin.

In the consumer electronics field—radio, television, and FM—Dr. Baker said that war research and engineering will bring many improvements. But, he cautioned, consumers should not be led to believe that the day after peace comes they will be able to buy television and FM radio sets for \$9.95. It will take a long time to reduce new wartime knowledge to peacetime practice.

If the war lasts until 1945, probably

only 50 per cent of the nation's radio receivers will be in operation.

This will mean a big demand for receivers when peace comes, and will keep workers employed while engineers are converting their new wartime knowledge to better peacetime products.

When the electronics industry returns to making consumer peacetime products, it will start where it left off when it converted to war production. New wartime developments will eventually be incorporated in these products but it won't be done overnight, he emphasized.

# ELECTRONIC SPOT WELDING

**A** NEW electronic half-cycle synchronous control for the precise operation of resistance-welding machines was announced last month by the General Electric Company. Mounted in a protecting cabinet, the control is furnished in two types, for bench and wall mounting. Both types can be used either with tongs or with a suitable bench welder.

The control uses a new tube, the GL-415, and a new circuit makes higher-speed welding possible. The initiating-circuit is simple and improves performance and reduces maintenance. The new design also incorporates heat-control by the phase-shift method. The heat adjustment is made by a dial mounted on the front of the cabinet.

## WELDS COPPER, STEEL AND ALLOYS

The control facilitates the welding of tinned copper, steel, or alloy wires; of studs from 0.01 to 0.05 inch diameter to flat surfaces, with little or no indentation on the opposite surface of the metal; and the spot welding of unusually thin (less than 0.01 inch) pieces of stainless steel, mild steel, nickel, or silver, to brass or bronze, with negligible oxidation or discoloration.

The control also makes possible the welding of low-resistance joints which are unaffected by temperatures considerably in excess of 257 deg. Fahr., the point at which certain types of soldered joints weaken and often collapse.

This results in the complete elimination of solder, with a corresponding saving of tin, and a saving of 50% in time.

Also, in many cases it greatly simplifies the problem of training new employees, since the technique of resistance-welding is learned much quicker and with much less waste of material than in the case of soldering.

This is another instance of the many modern time-saving, material-saving and temper-saving devices, operated electronically, which have been developed under the impetus of wartime demands at busy factories. Principles long known or used in the radio art, are being adapted to industrial use through electronics.

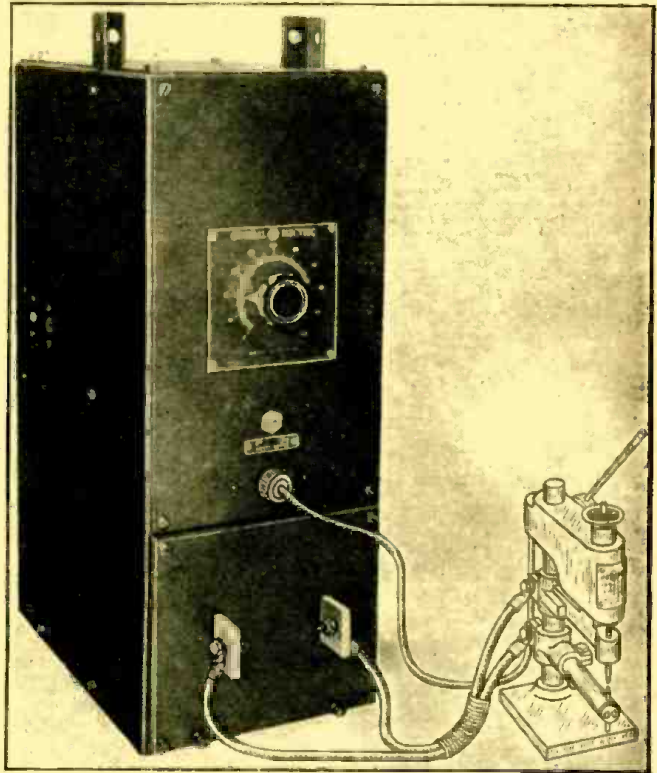

## ENGLISH WOMEN SPOT NAZI PLANES (Cover Feature)

**O**UR front cover shows a young member of the Auxiliary Territorial Service (usually abbreviated A.T.S.), intent on the job of spotting enemy planes.

Note that the device seems to call for the use of two senses—sight and hearing—requiring concentration and constant alertness.

Britain's radio manufacturers did a terrific job, early in the struggle, when they concentrated all their energies on fabricating the radiolocation sets that later contributed to a great extent in winning the Battle of Britain.

Now that the location stations are set up, they help enormously in speeding up the take-off of defense planes over England.

So part of the tribute must go to these gallant lassies of the A.T.S. who have come from all walks of life to take the place of men in "desk jobs," enabling the men to take their places in combat or supporting ranks. These girls in the special services are specially selected and trained. The training is intense and requires intelligence and keen perceptive powers.

It might be mentioned here also that the new women's units of the Navy, Army, Coast Guard and Air Force will probably perform similar functions in this country.

Some of them have already had extensive experience with the interceptor commands in tracing the flight of planes in and about our coastline.

Others, trained in code and message handling, as pertains to interception, also will fill men's jobs in the various services.

When this gets under way we visualize a terrifically efficient handling of all modes of defense in this global war.—*Photo British Combine.*

## RECENT ELECTRONIC DEVELOPMENTS

**T**O tell the whole story of the electronic industry's research developments during the past few months is impossible, yet the research scientists though busy with the problems of war, have brought about new devices and apparatus that will benefit all when peace comes.

In the laboratories of the General Electric Company the induction electron accelerator, capable of producing X-rays and electron streams at 100,000,000 volts nears completion. The electron accelerator does for electrons what the cyclotron does for protons, and gives the high acceleration, without the use of high voltage in its production.

The portable electron microscope, which brings the instrument within the reach of all, and having a resolving power better than 10 times that of the ordinary microscope which depends on illumination, was announced. This portable model uses electrostatic fields for focusing, so needs only one unregulated voltage to ground, which can be supplied by the ordinary house circuit. The last stage of magnification is achieved through light-optics, permitting flexibility in magnification by the conventional interchange of lenses.

Rack-and-panel construction has now been extended to the carrier-current transmitter-receiver assemblies.

Telemetering load control, and protective relaying operations over high-voltage lines in carrier-current channels also was achieved.

A water-cooled transmitting tube for use in wide-band television amplifiers was designed to incorporate such features as inverted anode and short lead-lengths,

with multiple terminal-mount connections, thereby reducing lead inductance and giving stable and efficient performance at high frequencies.

A small light-weight gas-filled metal thyratron incorporating many of the features of small metal radio receiving type tubes, was developed for applications where space and weight are important.

For the steel industry there was built a 20,000-KW electronic frequency-changer, Grid control will regulate the power flow automatically, compensating for fluctuations in frequency and voltage. Power reversals can be made without any switching in the power circuit.

For resistance welding of heat-treatable steel alloys there was developed a special electronic control of such accuracy and flexibility that it was possible to control automatically both the magnitude of the welding current and the time of flow in order to control accurately not only the welding temperature but, even more important, the temperature for grain refinement or tempering of both. A simple form of current regulator was applied in the seam welding of oil drums, holding the welding current constant regardless of variations in line voltage or the addition of magnetic materials in the throat of the welding machine.

The development of new and improved products was not the only matter to occupy the attention of engineers during the year. Even before the start of the war, attention was being devoted to finding alternate materials to replace rubber, tin, aluminum, and all the other materials which had become precious.

# RADIO LOGS PLANE DATA

Perhaps the outstanding contribution to the development of American warplanes since the nation entered World War II is the radio test flight recorder, perfection of which was announced last month by engi-

neers of Vultee Aircraft, Inc., at Downey, Calif.

The new device, a radio-operated mechanism, instantly transmits from an experimental airplane to laboratory crews below,

a complete picture of the strains and flutters, characteristics, performance and reactions which in today's high performance aircraft occur too rapidly for a test pilot's eyes and hands to notice and record.

The automatic recorder makes it possible for the technicians on the ground to know more, actually, about the new airplane's condition while in flight than does the pilot at its controls, so that should dangerous indications develop the pilot can be warned, and in the event of a crash, no data are lost, as factors contributing to the failure have been recorded instantaneously and permanently. Thus, months and even years of time, which hitherto were lost in such failures, now can be saved.

The fact that the radio recorder covers seventy points throughout the structure of the airplane makes it possible for the technicians to observe and record more structural and engine indications in one flight than hitherto have been possible to record in a score of such flights, a tremendous factor in time saving during aircraft development.

The radio test flight recorder is the invention of H. D. Giffen, former motion picture sound engineer who now is on the Vultee staff of development engineers.

The device is the result of fourteen months of development work.

Among the indications reported by the pick-up units located in several points about the plane, are air speed, engine manifold pressure, altimeter, tachometer (both engine and turbo-supercharger), flowmeter, accelerometer, temperature indication (fuel, oil, air, engine, coolant), liquid pressure gauges (fuel, oil, prestone, etc.), air pressure gauges (carburetor ram, radiator cooling air flow, engine cooling air flow, air oil pressure survey, etc.), strain (control cable loads, hinge loads and other structural loads), push-pull control rod loads, position and movement indicator (control surfaces, cowl flap, landing gear, wing flaps, etc.)

The instrument indications are transformed by equipment located in the airplane into an electrical frequency in the audio range. The frequency of each signal depends upon the voltage of the pick-up, the voltage itself being a function of the instrument indication. This signal frequency is transmitted over an audio frequency radio, which may be the standard equipment of the airplane, to the ground, where it is automatically recorded.

Recording is accomplished by a standard 16 mm. sound recorder, or, in the case of continuous indications, by a standard high-fidelity disc recorder.



The new radio test flight recording device perfected by engineers of Vultee Aircraft, "feels" reactions of new airplane during test flight, and radios them to apparatus on ground which records them instantaneously and permanently, thereby relieving the test pilot of such duties. He may thus lose glamour, but it speeds up the completion of American warplanes. The inventor, Harvey Giffen, foreground, former movie sound technician, and Duncan Griffith, assistant, are shown loading the aerial unit into the plane.

## 50,000 WATTER ON AIR FROM RIO

A powerful voice rose on the radio front of the Western Hemisphere when Radio Nacional, the new 50,000 watt shortwave station went on the air from Brazil's Rio De Janeiro on New Year's night.

Dedicated to the strengthening of inter-American friendship and understanding, Radio Nacional now beams a nightly program to North America on 26.5 metres, using talks, skits and Brazilian and American popular music to give its shortwave audience a picture of South America and its people.

The station equipment was built and installed by the RCA Victor Division of the Radio Corporation of America, which spon-

sored the initial program in Rio. The equipment was completed ceased commercial production last year. Radio Nacional was opened with a gala inaugural program. Master of Ceremonies was Lieutenant Commander Walter Winchell, USN, who was on a special mission in Brazil. Guests of honor were Oswaldo Aranha, Brazilian Foreign Minister, Jefferson Caffrey, American Ambassador to Brazil, and Senor Morales, Chilean cabinet minister.

The program was picked up in N. Y. and wired by direct line to NBC and WRC.

Highlight of the program was a toast for the Americas introduced by Lt. Commander Winchell and since adopted by the South

American press. With Mr. Caffrey and Senors Morales and Aranha clinking coffee cups, Winchell declared the scene was symbolic of North America's feeling for her Southern neighbors: "Never above you; never beneath you; always beside you."

Now the most powerful shortwave broadcast station in South America, Radio Nacional is a symbol of the might and power of radio in the present war.

She takes her stand with other radio stations all over the world now battling the Nazi-Jap axis and strengthening the bonds of friendship and understanding among the peoples of the United Nations.

Below—Fledgling radio operators get a kick out of their first experience calling the ground station from the plane.



Below—studying operating procedure on an aircraft unit.

Left—Installing an antenna on a bomber while other students have a look at the radio system.



## RADIO TRAINING IN THE AIR FORCES

EVERY four-motored bomber has two radio operators, and every coastal airport in this country, bound in the network of air defense, has its complement of radio operators.

Without these skilled operators and their brother mechanics and trouble shooters, the Air Forces would be grounded.

The task of the Army Air Forces Technical Training Command is to supply these vitally needed radio operator-mechanics. To this end, the Technical Training Command operates five radio schools which are producing thousands of radiomen. Scott Field, Ill., a base for training flyers in World War I, is the parent radio school of the TTC. Others are located at Madison, Wis., Sioux Falls, S. D., and Chicago.

The importance of the radio operator cannot be over-emphasized. It is the radio operator who keeps in contact with the home base and receives orders, instructions and weather data. In actual combat, when radio apparatus must be silenced to prevent giving information to the enemy, the radio operator mans his own gun when Jap and Nazi fighter-planes attack, or he might replace some other gunner who has become a casualty.

How is a radioman trained for actual combat? First of all, he is selected on the basis of his rating in the army aptitude test conducted at reception and basic training centers. He must make a high grade.

After being assigned to one of the radio schools, he studies six days a week, seven hours a day. The first courses are in radio operating and mechanics, and take 18 weeks to complete. Upon completion, the student is graduated as a radio operator-mechanic.

The first subject the student covers in Radio Mechanics is a 70 hour course in direct and alternating current theory. In this course the student studies elements of electricity, both A. C. and D. C., Ohms Law for A. C. and D. C., the phenomena of magnetism and induction, and the generation of electrical power. Series and parallel circuits containing resistance, inductance and capacitance, the principles of transformers, rectifiers and electrical measuring instruments, etc., are also taken up.

The next 70 hours covers the theory of antennas, vacuum tubes and the construction of radio transmitters, oscillators, and amplifiers.

Fundamental training includes a 35-hour course in radio receivers, embracing the principles of radio reception, detection, radio frequency and audio amplifiers, and elementary theory of the operation of tuned radio frequency and superheterodyne receivers.

Upon successful completion of the fundamental course the student moves to the Aircraft Radio division of the school. There he studies radio transmitters and receivers, and spends a total of 175 hours on the op-

eration, tuning, trouble shooting, maintenance and inspection of aircraft transmitters, receivers and radio compasses. This phase of the training usually is climaxed with ten days of actual operation of ground stations.

Three and one half hours of the student's day is spent in learning the International Morse code.

Previous formal education has little relation to the progress of a student in mastering the Morse code. All start from scratch and inherent aptitude is the main factor.

Students advance by successive stages from four words per minute until they reach the required maximum of 16 words per minute, although some are capable of speeds as high as 50 words per minute.

Instruction takes place not only in the classrooms, but also in mobile units, and, for the more advanced students, in "Flying Classrooms" which circle high above the field.

Upon graduation, many radio operators are sent to gunnery schools where they learn how to operate .30 and .50 calibre machine guns. After a short course they are sent to the operational training centers to be welded into bomber crews—to become part of a team that will eventually see service overseas. Some of them, transcending their routine training, become modern warriors of the clouds, because, sooner or later, every radioman has to drop his earphones and grab a machine gun instead.

## RADIO INSTRUCTORS NEEDED

THERE is an urgent need for men and women to serve as civilian instructors in radio at the Army Air Forces Technical School, Sioux Falls, South Dakota. Starting salaries range from \$1620 to \$2600 per annum, depending upon the education and experience of the applicant. Minimum requirements include a high school education (which may be waived in some cases), plus one of the following:

1. Holds, or has recently held, an amateur or commercial radio operator's license.
2. One year's experience as a radio op-

erator, radio engineer, or radio repairman.

3. Successful completion of a six months' resident course in radio, or an E. S. M. D. T. radio course.

4. One year of college work in a recognized institution.

Applicants who have had at least six months' experience in advanced and difficult radio work, who have taught radio or allied subjects for at least six months or who have a degree in electrical or radio engineering or the equivalent, will qualify for a starting salary of \$2000.

Those with certain additional experience may qualify for a starting salary of \$2600 per annum.

For full particulars write to the A. A. F. Employment Officer, Army Air Forces Technical School, Sioux Falls, South Dakota.

Here is a chance for a lot of you fellows who know your radio.

In answering these appeals for those interested in applying, please be prepared to act on your decision if your qualifications enable you to accept.

# WARTIME TUBE REPLACEMENTS

By HAROLD DAVIS

**F**INDING the correct replacement for defective radio tubes looms as the most vexing problem facing the few remaining radio servicemen. Although there are hundreds of types on the market, each carries its peculiar characteristics that prevent it from being readily exchangeable with some other type. Some differ only in filament voltage or in the type of base used. It is these in which we are primarily interested, because it is relatively easy to change a socket and sometimes just as simple to regulate the filament voltage.

the correct values for the particular plate voltage being used. Bias and screen voltages are controlled by the size of the respective cathode and screen resistors.

Another important consideration is the load into which the tube works. High-gain voltage amplifiers, R.F. and audio, work into high impedance or resistance loads. Power tubes, on the other hand, work into comparatively low loads. It is not practical to work high-gain audio tubes into transformers, because of the difficulty in building high resistance transformers. It is like-

the old 24-A. At least this was the first popular one. This was followed by the 58, 78, 6D6 and later the 6K7, and its many variations. Any of these tubes are good R.F. tubes, and when fitted with the correct voltages, will perform satisfactorily in most circuits.

All modern R.F. amplifiers are either pentodes or tetrodes. Low inter-element capacity is essential for efficient R.F. amplification. Screen grid tubes (tetrodes) meet this requirement, and pentodes go a step further by providing a third grid called the "suppressor," which collects the secondary emission from the plate and adds additional stabilization.

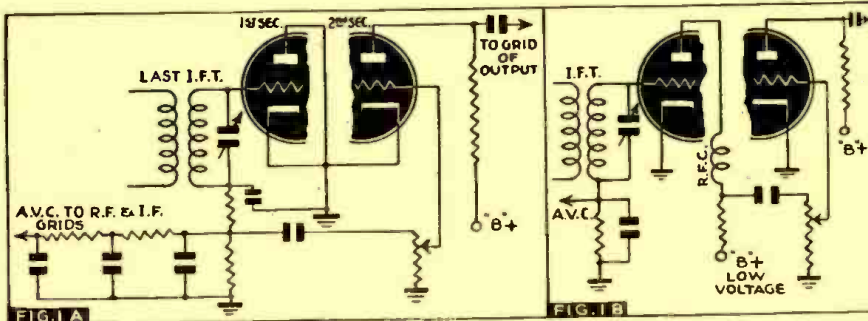

FIG. 1A—Duo-triode used as diode-triode. Here the control grid of one section replaces the diode. Note that the plate is grounded. Fig. 1B—Duo-triode replacing duodiode-triode. The grid supplies AVC. The plate supplies the audio component.

However, as time goes on and the pinch of priorities is felt more and more, it is quite likely that entire circuits will have to be changed to fit the particular tube on hand. This article is being written to give the servicemen an idea of what can be done along this line. It is not to be misconstrued to be absolutely official. Instead, much of the information contained is suggestive, and was originated by combining logical reasoning with past experience.

The first step in attempting to replace a tube with a different number is a careful study of the characteristics of both tubes,

wise unpractical to resistance couple R.F. amplifiers because if the resistance were made sufficiently high to match the tube, it would require a voltage supply running much higher than normal in order that the correct amount would reach the plate after flowing through this high resistance.

However, the correct matching of input and output circuits take care of itself in most cases, if the *correct type* of tube is selected.

## CLASSIFICATION OF POPULAR TUBES

In the modern superheterodyne receiver

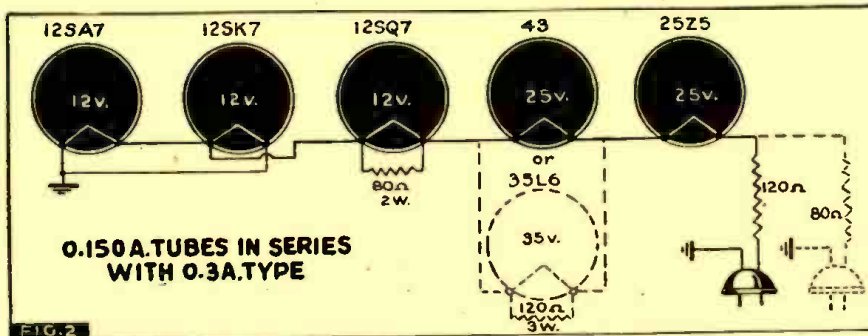

FIG. 2—12-volt .150 Amp. tubes used in series with .300 Amp. tubes by use of parallel resistor and parallel tubes to balance the circuit at .300 Amps. Optional circuit shown in dotted lines.

as given in a good tube manual, paying particular attention to the control grid bias; screen grid and plate voltages and their ratio to each other.

Most radio tubes will operate over a wide range of voltages, provided these voltages are kept balanced; i. e., the control grid and screen voltages must be regulated to

there are only five general types of tubes: Radio frequency amplifiers (I.F. included)

Converters—Mixers

2nd Det.—1st audios

Outputs

Rectifiers

The first real R.F. amplifier was probably

## CONVERTERS-MIXERS

Frequency converters are of two general types; those providing for internal oscillators, 6A7, 6J8G, 6K8 and their many equivalents with different bases and filament voltages, and those requiring a separate tube as an oscillator like the 6L7. This tube is different from regular R.F. amplifiers in that it provides a grid for the induction of the externally generated oscillator signal.

The 6SA7, while falling into the first group of converters, warrants special mention because of its unusual circuit. In this tube there is no oscillator anode (plate), which accounts for there being only two high voltage points on the socket instead of the customary three found on the 6A7 types. The oscillator anode or plate is connected internally to the screen grid. This suggests that a good substitute for a 6SA7 would be a 6A8 with the oscillator plate tied to the screen grid.

The 6SA7 might be used in some cases to replace a 6L7, grid No. 3 being the injector grid.

## 2ND DET.—1ST AUDIOS

There are two general classes of 2nd. Det.—Audio tubes; the duo-diode-triode and the duo-diode-pentode. The first group contains both high and low mu tubes, interchanging of which should require only adjusting the plate resistor. Duo-triodes can be used as 2nd. Detectors and first audios, one section being used as the detector and the other the 1st. audio, Figs. 1A and 1B.

## OUTPUT TUBES

Output tubes fall into two general groups also; triodes and pentodes, the exception being the beam type such as the 6L6. The only differences in outputs are in the output loads and the amplification factors. Power output is of little consequence, as practically any of the power tubes will afford enough volume for normal listening.

Practically the only triode output still in existence is the 45, or perhaps an occasional 31 in the battery type. The 2A3 was not generally used in receivers. A 47 with the screen tied to the plate replaces a 45 very well. So will most other pentode types if the filament and grid voltages are adjusted.

The pentodes are many and varied, beginning with the once popular 47 and ending with the old reliable 6F6. Practically



all pentode output tubes can be interchanged with adjustment of voltages.

The beam types, headed by the popular 6L6, are closely related and should be easily interchanged. They can also be interchanged with the pentodes by changing the output transformer.

**RECTIFIERS FOR A.C.-D.C. RECEIVERS AND A.C. CATHODE TYPES**

Rectifiers are more difficult to classify than other radio tubes. The most outstanding features from a replacement standpoint are the open filament and the cathode types, for the A.C. sets, and the A.C.-D.C. high voltage types. In the first group the old 80 heads the list and can be substituted in most circuits by simply changing the socket. In the second group the 6X5 is most popular and unless the set has a separate filament winding, there are few substitutes.

The A.C.-D.C. rectifiers are primarily different only in filament voltages, but care must be taken in substituting close cathode types such as 25Z6 in circuits where large input filter condensers are used. These large input condensers may draw enough current when they first take a charge, to blow the rectifier.

**TUBES INTERCHANGEABLE WITH SLIGHT VARIATIONS**

In attempting to interchange a tube, the first consideration is the type. For instance, a 6K7 is an R.F. amplifier, and only a tube of the R.F. amplifier family can be used. However, there are some tubes that serve two or more purposes. For example, a 6J7 could be used as an R.F. amplifier, although it is generally used as a high-gain audio amplifier. A 6J7 is directly interchangeable with a 6K7 as far as base connections are concerned. A comparison of characteristics will find them very similar.

Other tubes may be used to substitute for the 6K7 or vice versa without a change in circuit, provided the socket is changed. We have in mind particularly the 78 and 6D6. They should be shielded if they replace metal tubes, and the circuit realigned. (Always realign R.F. circuits.)

Converters will be found more difficult to interchange than most other types. However, 6A8 and 6A7s are interchangeable with a change in socket. The single-ended types like the 6SA7 can usually be matched out of the 10ktal family with a change in socket. (Radiomen might just as well get used to this "change in socket" idea because there is going to be lots of it.)

The duo-diode-triode, or 2nd. Det.-1st. audio should be easy to replace. It is not critical and many similar tubes are on the market. 6Q7, 6R7, 6T7 and 75 are all very similar, and the 6C7 will require only a simple terminal change. Most circuits use only half-wave rectification, which requires only one diode, and the second is left floating or tied directly to the one being used.

Duo-diode pentodes can be used with a change in socket connections and the addition of a screen circuit.

Output tubes are already causing trouble. 6L6s are available only on high priority. 6F6s are scarce.

The 6L6s may be interchanged directly with their smaller equivalent the 6V6. Either can be replaced directly with the 6U6GT or the 6Y6G, by adjusting the bias resistor. Also with the 7C5 by changing the socket only.

The popular 6F6 can be replaced directly with the 6G6 or 6K6 in most cases; and with a change in the bias resistor in others. Also with the 7B5 by changing the socket.

The high voltage outputs such as the 35L6, 50L6, etc., can also be used by providing the proper filament voltage.

Practically any available output tube can be used in any set provided the proper output transformer and the filament voltage is used.

**RECTIFIERS OF THE UNAVAILABLE TYPE**

Finding substitutes for unavailable rectifiers should be simple. The old reliable 80 will replace the 83 and 5Z3 directly if too much current is not drawn, and it seldom is in receiving sets. Current requirements may be lowered in large sets by replacing high powered output tubes with ones requiring less current. The 80 will also replace practically any of the 5 volt series with a change in sockets. This is true even of the cathode types, although in replacing the latter it is wise to see that a good bleeder resistor is installed if not already incorporated in the circuit. The reason for this is that the open filament rectifier like the 80 begins to deliver current before the other tubes warm up and the voltage goes high without a bleeder, sometimes blowing

Where 1st tube is one being replaced and the 2nd tube is one replacing.

Example:

$$\frac{(35)}{(.300) - (.150)} = \frac{35}{(.15)} = 233 \text{ ohms}$$

The fact that tubes drawing only .150 Amps. cannot be used in series filament arrangements with tubes drawing .300 Amps. is unfortunate because in all probability the former, which are higher voltage tubes like the 12, 14 and 35 volt series require only .150 amperes, will be exhausted first, while the old 6-volt line requiring .300 Amps. will be available longer.

This is also true of the 35Z5 which draws .150 amperes and the 25Z5 requiring .300. The 35Z5 is already difficult to obtain, while the 25Z5 is still plentiful.

Should it be necessary to change a 35Z5 to a 25Z5, the output tube should be changed

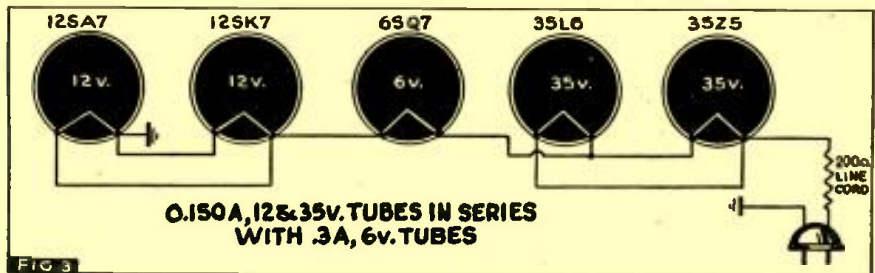

One 6-volt .300 Amp. tube may be used in a network of 12- and 35-volt .150 tubes if connected as shown. The parallel arrangement of the 12- and 35-volt tubes raises the current of the network to .300, but lowers the voltage drop of the entire network from 106 volts to 53 volts, making it necessary to add a 200 ohm line cord.

the filters or arcing over in the tube.

In the case of A.C.-D.C. sets with the filaments in series, many replacements can be made with a change in sockets and regulating of filament voltage. Most of the sets use simple half-wave rectifying circuits and even a triode or a pentode with screen tied to plate will do the rectifying job, provided the filament voltage is correct.

**TUBES IN SERIES**

An important word of caution is in order.

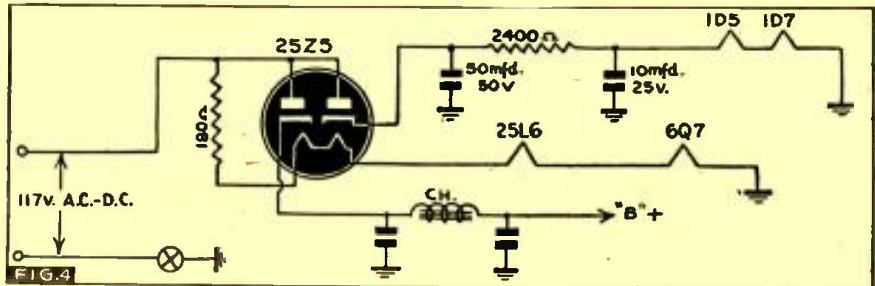

One cathode of a 25Z5 may be used to supply D.C. for battery tube filaments used to replace 6-volt types.

Tubes used in series must draw the same current. (Current in a series circuit is always the same at all points.) Accordingly a 25Z6 could not replace a 35Z5, because the former draws .300 Amps and the latter only 0.150. However the latter could be used to replace the former by placing a resistor of 230 ohms across the filament. The formula for this resistor which can be calculated for any tube is as follows:

$$\text{Heater shunt-resistor ohms} = \frac{\text{Heater Voltage}}{\text{Heater current of first tube minus heater current of 2nd tube}}$$

rent, and the wattage found by I<sup>2</sup>R. Example:

$$R = \frac{(12.6)}{(.15)} = 84 \text{ ohms}$$

$$\text{and } W = (.15)^2 (80) = (.0225) (80) = 1.8 \text{ watts}$$

The value of the resistors in line cords is calculated by the regular formula, R = E/I, where E equals (117 minus the sum of all the voltage drops across the filaments or heaters), and I equals the current through the heaters. For I, use the current value of any tube. (All tubes must pull the same current in a series circuit.)

(Continued on page 289)

FIRESTONE MODEL NO. S7406-7

ANTENNA AND GROUND

A Firestone "Powerscope" is built into this receiver and under normal conditions will give satisfactory reception. In locations remote from broadcasting stations, or where poor receiving conditions exist, it may be necessary to use an outside antenna. This antenna may be a single wire from 35 feet to 75 feet long, including the lead-in wire, erected as high as possible and as far from electric light wires (or other sources of noise) as possible. When an antenna is used a good ground should also be used. The antenna wire is connected to the screw marked "A" and the ground to the terminal, marked "G", located at the rear of the chassis.

The "Powerscope" in these instruments is rotatable and may be turned by means of the middle knob on the panel (see Fig. 1). A stop is provided to prevent the "Powerscope" from turning too far. This knob should be used to adjust the "Powerscope" towards the station, or that direction which gives the best reception, i. e., loudest signals with least interference. In



The "Hepplewhite" console, radio-phonograph combination, Model No. S7406-7.

some locations it may be found that stations can only be received with the "Powerscope" in one position. This is a local condition and may be due to local shielding.

INSTRUCTIONS FOR SETTING STATION TUNING BUTTONS

At the rear of the cabinet directly back of the dial assembly are six (6) pairs of screws (See Fig. 1). A paper cover is provided which shows the frequencies covered by each pair of screws. The right hand pair of screws, looking at the rear of the set, are connected with the left hand station button when looking at the front of the set.

Allow the set to warm up for about one-half hour before starting to set up the buttons.

1. Make a list of the six (6) stations you desire to tune in by the buttons, arranged in order of their frequencies.
2. Select the buttons which correspond to the above frequencies.
3. Press the button marked "Manual" and carefully tune in the station on the above list having the lowest frequency.
4. Press the button selected for this station.
5. Adjust the upper brass screw of the pair corresponding to the button selected for this

station until the wanted station is heard most clearly. These are marked Adj. Screws, Osc. Coil Trimmer Strip in the accompanying illustration, (Fig. 1).

CAUTION: When setting up the stations it is well to select a time when they are not carrying "chain" programs, as the adjustment might be made on the wrong station.

Care should be exercised when adjusting the screws for if they are forced damage may result to some associated parts.

If tubes are removed from set, for any reason, make certain they are replaced in accordance with Fig. 2.

Speed of Motor: 76.59 to 80.00 R.P.M.

Lubrication: 2 or 3 drops of oil every six months on the two felt washers in spindle gear bracket, and in motor on the two in the motor.

One drop of oil on pin for roller of tone arm lift lever.

Light application of white vaseline on teeth of main cam; also some on face of cam where tone arm swing lever rides.

One drop of oil on 10" and 12" plungers. Keep oil off motor pulley, idler pulley or rim of turntable.

Do not oil friction trip assembly.

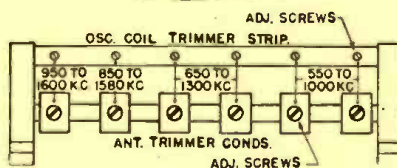
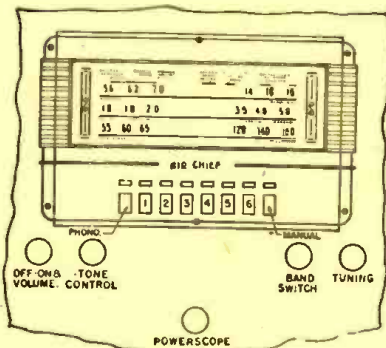

VIEWED FROM REAR OF CABINET  
Fig. 1

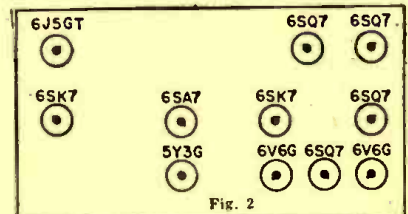

Top view of chassis showing location of tubes.

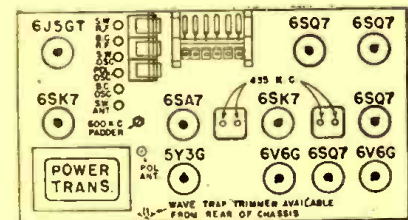

Front of Chassis

ALIGNMENT DATA

| Dummy Ant. In Series with Sig. Gen. | Connection of Sig. Generator Output to Receiver | Signal Generator Frequency | Band Switch Position | Receiver Dial Setting                         | Trimmer Description                 | Type of Adjustment  |
|-------------------------------------|---|----------------------------|----------------------|---|-------------------------------------|---|
| .1 MFD Condenser                    | Lug on Rear Section of Gang Cond.               | 455 KC                     | Broadcast            | Any Point Where It Does Not Affect the Signal | 2nd I.F.<br>1st I.F.                | Adjust for Maximum Output. Then Repeat Adjustment.  |
| 250 MMF.                            | "Ant." Terminal                                 | 455 KC                     | Push In No. 6 Button | Any Point Where It Does Not Affect the Signal | Wave Trap                           | Adjust for MINIMUM Output. Using a Strong Generator Signal.   |
| 250 MMF.                            | "Ant." Terminal                                 | 1600 KC                    | Broadcast            | 1600 KC                                       | Broadcast Oscillator (Shunt)        | Adjust for Maximum Output.  |
| 250 MMF.                            | "Ant." Terminal                                 | 1500 KC                    | Broadcast            | Tune to 1500 KC Generator Signal              | Broadcast R.F. Loop Trimmer         | Adjust for Maximum Output.  |
| 250 MMF.                            | "Ant." Terminal                                 | 600 KC                     | Broadcast            | Tune to 600 KC Generator Signal               | 600 KC Padder                       | Adjust for Maximum Output. Try to Increase Output by Rocking the Gang until Maximum Output is Obtained.   |
| 400 OHM Carbon Resistor             | "Ant." Terminal                                 | 5.4 KC                     | Intermediate         | 5.4 MC  | Police Oscillator                   | Adjust for Maximum Output. Check to see if Proper Peak was Obtained by Tuning In Image at Approx. 4.5 MC. If Image does not appear, Realign at 5.4 MC, with Trimmer Screw farther out. Recheck Image.   |
| 400 OHM Carbon Resistor             | "Ant." Terminal                                 | 5 MC                       | Intermediate         | Tune to 5 MC Generator Signal                 | Police Antenna                      | Adjust for Maximum Output.  |
| 400 OHM Carbon Resistor             | "Ant." Terminal                                 | 18.1 MC                    | Foreign              | 18.1 MC                                       | Shortwave Oscillator                | Adjust for Maximum Output. Check to see if Proper Peak was Obtained by Tuning In Image at Approx. 17.2 MC. If Image does not appear, Realign at 18.1 MC, with Trimmer Screw farther out. Recheck Image. |
| 400 OHM Carbon Resistor             | "Ant." Terminal                                 | 16 MC                      | Foreign              | Tune to 16 MC Generator Signal                | Shortwave Antenna<br>Shortwave H.F. | Adjust for Maximum Output.<br>Try to Increase Output by Rocking the Gang until Maximum Output is Obtained.  |

# Radio Service Data Sheet

330

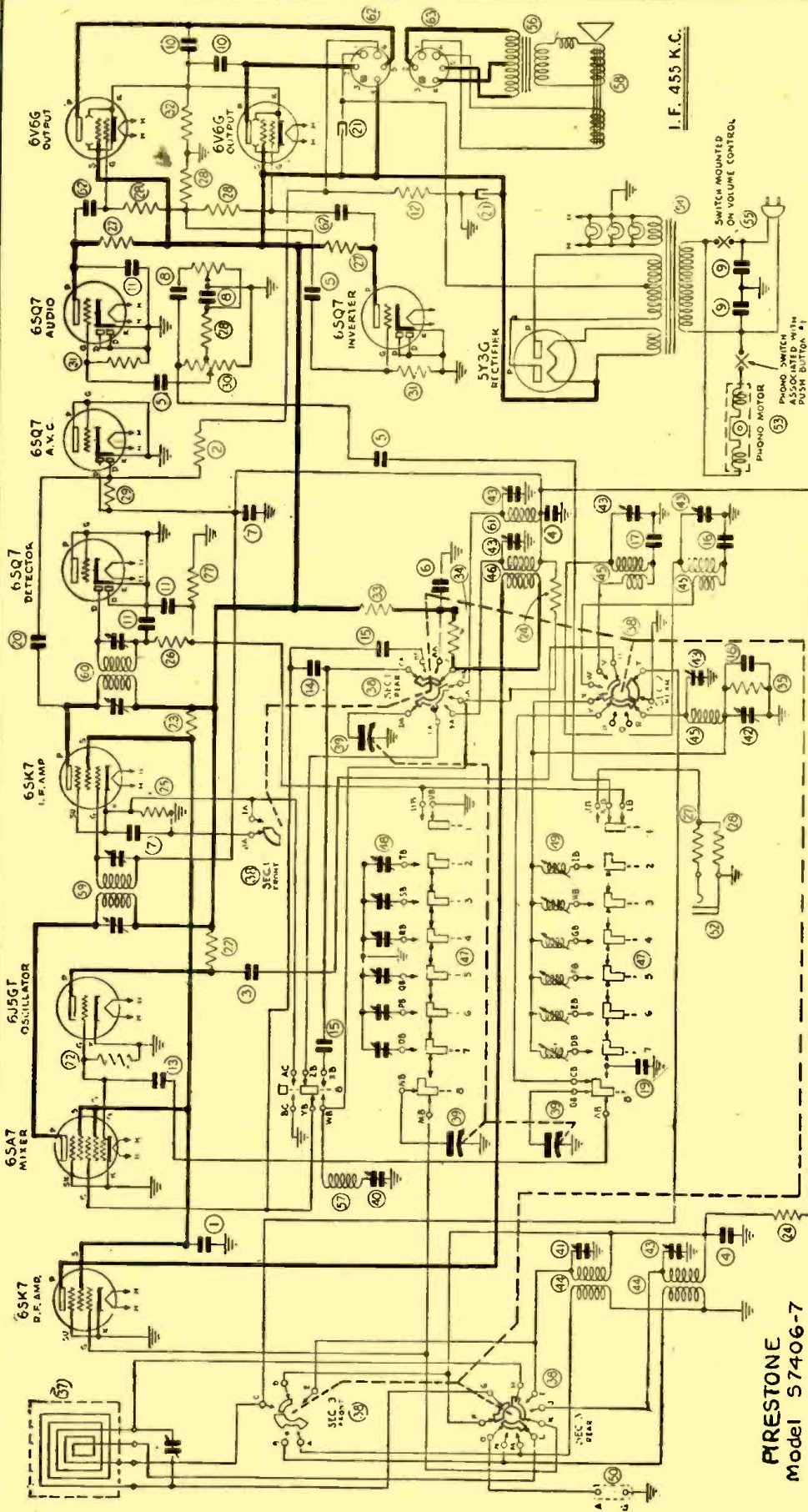

**FIRESTONE**  
Model S7406-7

Parts List

| Diagram No. | Description                             | Diagram No. | Description                     | Diagram No. | Description                    |
|-------------|---|-------------|---------------------------------|-------------|--------------------------------|
| 1           | .1 mfd., 600 Volts                      | 31          | 10 Meg. Ohm, 1/2 Watt           | 47          | Push Button Assembly Switch    |
| 2           | 2.2 Megs., 1/2 Watt                     | 32          | 220 Ohm, 2 Watt                 | 48          | Push Button Trimmer Switch     |
| 3           | .005 mfd., 600 Volts                    | 33          | 1500 Ohm, 1/2 Watt              | 49          | Button Oscillator Coil Strip   |
| 4           | .05 mfd., 200 Volts                     | 34          | 4700 Ohm, 1/2 Watt              | 50          | Antenna and Ground Strip       |
| 5           | .01 mfd., 400 Volts                     | 35          | 10 M Ohm, 1/2 Watt              | 51          | Pilot Lamp                     |
| 6           | .05 mfd., 600 Volts                     | 36          | 2.2 Meg. Ohm, Tone Control      | 52          | Phono Input Jack               |
| 7           | .1 mfd., 200 Volts                      | 37          | Loop Assembly                   | 53          | Phono Motor                    |
| 8           | .002 mfd., 600 Volts                    | 38          | Band Switch Assembly            | 54          | Power Transformer              |
| 9           | .01 mfd., 600 Volts, Molded Con- denser | 39          | Tuning Condenser Gang           | 55          | A. C. Cord                     |
| 10          | .01 mfd., 600 Volts                     | 40          | Short Wave Trimmer              | 56          | Output Transformer             |
| 11          | 100 mmf., Mica                          | 41          | Wave Trap Trimmer               | 57          | Wave Trap Coil Assembly        |
| 12          | 22 Ohm, 1/2 Watt                        | 42          | Trimmer Padder                  | 58          | Speaker Complete               |
| 13          | 50 mmf., Mica                           | 43          | Antenna Coil Assembly           | 59          | I. F. Trans.                   |
| 14          | 10 mmf., Mica                           | 44          | Oscillator Coil Assembly        | 60          | I. F. Trans.                   |
|             |   | 45          | Mixer Coil Assembly, Short Wave | 61          | Mixer Coil Assembly, Broadcast |
|             |   | 46          | Mixer Coil Assembly, Short Wave | 62          | .02 mfd., 600 Volts            |

# ALIGNING SUPERHETS

By ALFRED A. GHIRARDI

It should be stated at the outset that if factory service instructions for a receiver are at hand they should be consulted for any special alignment instructions. Such instructions have been prepared by the engineers who designed the receiver and they are familiar with the difficulties connected with proper operation and alignment of the receiver.

It must be understood that the underlying reason for the following data is to furnish a standard basic alignment procedure that will apply to most cases.

Fundamentally the most satisfactory sequence of alignment consists of:

1. Preliminary preparations.
2. Peaking the I.F.
3. Adjusting the oscillator.
4. Aligning the R.F. stages.

## PRELIMINARY PREPARATIONS

The signal generator to be used, and the receiver to be aligned, should be turned on so they can heat up to operating condition.

A study of the circuit, and the location of the various stages and parts on the chassis, should be made so that it is known whether the circuit contains A.V.C., A.F.C., Q.A.V.C., etc., and where the trimmer adjustment screws for the I.F., R.F. and oscillator circuits are located.

An important precaution is to be observed when using an output indicator with sets having A.V.C. That is, to "kill" the A.V.C. action. The reason for this is that the A.V.C. reduces the sensitivity when the output signal tends to rise on alignment. This tends to give constant output, and it would therefore not be possible to tell when correct adjustment for exact resonance had been made.

The best method to use for interrupting the A.V.C. action depends on the arrangement of the particular receiver, but where the A.V.C. originates in a diode-triode detector-amplifier, the simplest procedure is to use a weak signal from the signal generator so that the A.V.C. action does not take place.

Another method would be to open the lead which picks off the A.V.C. voltage from the A.V.C. circuit and distributes this voltage to the controlled tubes. The part of the lead which goes to the grid circuits could then be grounded directly to chassis. This places only the small residual bias on the tubes, which raises the sensitivity of the receiver to maximum, necessitating a reduced signal from the signal generator. This latter method is of value with 6Q7, 6B6-G, 7C6, 6B8, 75, 55, 85, 2B7, 6B7 type tubes. Bear in mind however, that it is not possible to disconnect these A.V.C. circuits without affecting the detector and first audio sections appreciably also.

If the receiver has A.F.C., with an "A.F.C.—Manual" switch, just simply turn the switch to the "Manual" position.

Short out the oscillator of the receiver before aligning the I.F. stages. Two simple ways to do this are:

1. Connect a short piece of wire between the stator and rotor plates.
2. If, as in some special cases, there is D.C. voltage present across these two points, it is best to substitute a 0.5-mfd.

capacitor to eliminate the possibility of shorting out this circuit and burning out the oscillator coil.

Perhaps it is best to use this capacitor in all cases just to be sure. The capacitor should be connected between the stator of the oscillator tuning condenser and ground,

*The procedure for performing routine service alignment on superheterodyne receivers has been explained in so many signal generator instruction manuals, manufacturer's service bulletins, and service magazines, that most radio service men understand it thoroughly.*

*However, for the benefit of beginners in the art of service work, and for those who know all about how it should be done, but who have permitted careless habits to develop in this important work, Mr. Ghirardi reviews it briefly here.*

or between the oscillator tube control grid and ground.

## PEAKING THE I.F.

Since maximum output from the I.F. amplifier will be obtained when it is adjusted to the exact frequency applied to it by the mixer, it is wise to align or peak the tuned circuits of each I.F. amplifier stage at the specific I.F. (or several frequencies close to it) for which the I.F. amplifier is designed.

First make sure that all the tubes are in their proper sockets, all control grid leads properly connected, and all shields properly in place.

Disconnect the aerial wire from the receiver. (But if there is a ground wire and it is usually in use when the set is operating, leave it connected.)

Connect the shielded output cable from the signal generator to the receiver, connecting the shield to the ground post of the receiver or to chassis. (if chassis is grounded), and the inner wire to the control-grid of the first detector or the mixer tube. This is the best connection for the I.F. alignment of most receivers. It is well to make this connection and then put the control grid clip and tube shield back in place.

Set the signal generator to deliver the correct intermediate-frequency, and hook up the output indicator (vacuum-tube-voltmeter; cathode-ray oscilloscope, etc.), to receiver output. Adjust the receiver volume control to "full."

Adjust the modulated signal from the generator to correct frequency and attenuation, until the output indicator reads about half-scale.

Work on the last I.F. first, i.e., the one before the detector, and adjust its condensers with an insulated screw driver or socket wrench. Turn the secondary condenser first, till indication is greatest.

If it is found that a transformer won't peak, check the trimmer condenser. It may

have been screwed down too tight and may need replacement.

Adjust primary trimmer condenser for greatest deflection. It will be necessary, as these adjustments are made, to decrease the attenuation on the signal generator, to keep the output indication on the scale.

Check secondary again, after adjusting primary, for often the adjustment of the primary changes the adjustment of the secondary slightly.

Repeat this for the primary condenser to make sure. Work back, stage by stage, toward the first detector. In each case, first the secondary, then the primary, tuning condenser is adjusted for highest reading on output indicator.

If the receiver is way out of alignment it is wise to follow the alignment procedure twice, in order to make certain that all circuits are in final correct alignment.

In receivers of the high-fidelity type, where the I.F. resonance curves have a flat top, exercise care not to cut the side bands. These transformers are not supposed to be peaked at any single frequency, but rather to a band of frequencies, say 4 or 5 kilocycles on each side of the main I.F. frequency, or in some cases 7.5 kilocycles each side.

The secondary is tuned to the higher frequency, and the primary to the lower. As a final check the signal generator dial should be rocked back and forth, and a more or less constant indication, with a slight dip in the center, should be noted on the output meter.

An alternative method consists of peaking the transformer and then detuning the primary below and the secondary above, peak frequency.

In both cases the criterion is that the deflection of output indicator should be the same on each side of the main I.F.

## ADJUSTING THE OSCILLATOR

Remove the short-circuiting wire (or the .5-mfd. used to short the oscillator tuning condenser when peaking the I.F. transformers).

If oscillator tracking is to be checked and adjusted, the output cable of the signal generator should be connected to the Ant. and Gnd. posts of the receiver; and all tubes, shields, and control-grid leads should be in their proper places.

First set the signal generator frequency to 1400 kc. This frequency is the one at which the adjustable high-frequency tracking trimmer of the oscillator is commonly adjusted so that the ganged oscillator-tuning condenser will track properly with the R.F. tuning circuit condensers at the high frequencies.

Tune in the 1400 kc. signal on the receiver. If not heard at the proper setting, but at some "off" point, say 1300 kc., adjust the R.F. tuning circuits to produce maximum output there.

Then turn the dial to a point nearer 1400 kc. and adjust the oscillator trimmer for maximum output, following with the R.F. condensers.

Repeat this alternate process, coming closer to the 1400 kc. dial division each

(Continued on page 312)

# TENTATIVE LIST OF REPLACEMENT PARTS

THE assurance of continued operation of home radio sets is the object of a task being undertaken by the American Standards Association, on the simplification and standardization of radio replacement parts.

The final standards will contain data on construction, dimensions and performance, and every effort will be made to make the parts mechanically interchangeable with present parts, with the minimum of difficulty.

The simplified standard line of parts will enable more efficient use of manufacturing facilities to be made, as contrasted to limited production of a large variety of parts as in the past.

The present tentative list of capacitors, volume controls, transformers, chokes, and coils, is presented herewith.

## CAPACITORS

### A. Dry Electrolytic.

| Capacity Mfd. | Rated D-C Voltage |
|---------------|-------------------|
| 100           | 25                |
| 10-10         | 50                |
| 20            | 150               |
| 20-20         | 150               |
| 40-40         | 150               |
| 10            | 450               |
| 10-10         | 450               |
| 40            | 450               |

Note: Capacitors are to be tubular type in cardboard container. Dual units to have separate sections.

### B. Paper.

| Capacity Mfd. | Rated D-C Voltage |
|---------------|-------------------|
| .01           | 120               |
| .05           | 120               |
| .1            | 120               |
| .0001         | 600               |
| .00025        | 600               |
| .0005         | 600               |
| .001          | 600               |
| .002          | 600               |
| .005          | 600               |
| .01           | 600               |
| .02           | 600               |
| .05           | 600               |
| .1            | 600               |
| .25           | 600               |

Note: Units to be in tubular cardboard containers.

## VOLUME CONTROLS

### A. Untapped Composition Type.

| Resistance | Taper   |
|------------|---------|
| 10 M ohms  | reverse |
| 25 M ohms  | reverse |
| 250 M ohms | audio   |
| 500 M ohms | audio   |
| 1 Meg.     | audio   |
| 2 Meg.     | audio   |

### B. Tapped Composition Type.

| Overall Resistance | Tapped Resistance   |
|--------------------|---------------------|
| 500 M ohms         | 150 M ohms          |
| 1 Meg.             | 300 M ohms          |
| 2 Meg.             | 15 M and 500 M ohms |
| 2.25 Meg.          | 500 M and 1 Meg.    |

### C. Wirewound.

| Resistance  | Taper  |
|-------------|--------|
| 10,000 ohms | linear |

Note: Controls to be furnished with fixed 1/4 inch steel shaft with .156 inch flat or with fixed shaft of split, knurled type. Shaft length 3 1/2 inch beyond 3/32 bushing. 3/8 inch long. Controls to be of "midget" or "junior" type, approximately 1 1/2 inch in diameter. No nuts, washers, ground terminals or bias resistors are to be furnished with controls.

All controls to be suitable for use with adaptable switches.

### Volume Control Switches

- Single pole, single throw
- Double pole, single throw
- Single pole, double throw
- 4 pole, single throw, shorting

Note: Switches to be of adaptable type and have U.L. rating of not less than 1 amp, 250 v and 3 amps, 125 v.

## RESISTOR TYPE LINE CORDS

|          |
|----------|
| 180 ohms |
| 350 ohms |
| 600 ohms |

## TRANSFORMERS AND CHOKES

### A. Power Transformers

| High Voltage  | Fil. 1             | Fil. 2            | Rect. Fil.    |
|---|--------------------|-------------------|---------------|
| 1. 325-0-325 V at 120 ma  | 2.5 V at 12.5 amps | 2.5 V at 3.5 amps | 5 V at 3 amps |
| 2. 250-0-250 V at 40 ma   | 6.3 V at 2 amps    | 2.5 V at 2 amps   | 5 V at 2 amps |
| 3. 325-275-0-275-325 V at 70 ma   | 6.3 V at 3.0 amps  | 2.5 V at 9 amps   | 5 V at 3 amps |
| (This transformer to be designed to deliver 22.5 watts maximum at any time from Fil. windings 1 and 2.) |                    |                   |               |
| 4. 350-300-0-300-350 V at 120 ma  | 6.3 V at 4.7 amps  | 2.5 V at 3 amps   | 5 V at 3 amps |
| 5. 350-0-350 V at 200 ma  | 6.3 V at 5.5 amps  | 2.5 V at 5 amps   | 5 V at 3 amps |

### B. Filament Transformer

| Fil. 1                    | Fil. 2          | Fil. 3          | Fil. 4        |
|---------------------------|-----------------|-----------------|---------------|
| 1. 2.5/1.5 V at 5.25 amps | 2.5 V at 3 amps | 2.5 V at 3 amps | 5 V at 3 amps |

(This transformer to be used in combination with those listed above, where necessary.)

Note: All transformers to be suitable for use on 50 or 60 cps current. An additional line of transformers similar to those listed except with a more humidity resistant construction for use in seacoast areas and Latin America will also be available. These units are to be tapped for 105, 120, 150, 210 and 240 volt operation.

### C. Chokes

- 7.5 Henries. at 200 ma maximum d-c, 200 ohms resistance.
- 15.0 Henries. at 120 ma maximum d-c, 350 ohms resistance. (It is felt smaller chokes can best be replaced with the least use of critical materials through substituting resistors and increasing the size of the filter capacitors.)

## D. Audio Transformers

- Interstage.
  - 3:1 ratio small transformer with 10 ma d-c maximum primary current.
  - Universal with 1:1, 3:1, 6:1 ratios possible. 10 ma d-c maximum primary current. Mounting space about 2 3/8 in. high x 2 3/8 in. wide x 2 in. deep, 2 3/8 in. mounting center.
- Driver. Universal type with 1:1, 1.5:1 and 2:1 ratios possible, 35 ma d-c maximum primary current. Mounting space about 2 in. high x 3 1/8 in. wide x 1 1/8 in. deep, 2-13/16 in. mounting center.
- Output. (All universal types, tube to voice coil.)
  - 4 watts maximum audio power, 50 ma d-c maximum primary current. Mounting space about 1-15/16 in. high x 2 3/8 in. wide x 1-1/16 in. deep. 2500 to 25,000 ohms primary impedance to 2, 4, 6, 8 and 15 ohm voice coils.
  - 8 watts maximum audio power, 70 ma d-c maximum primary current. Mounting space about 1-9/16 in. high x 2 3/8 in. wide x 1 1/8 in. deep. 2500 to 13,000 ohms primary impedance to 4, 6, 8 and 15 ohm voice coils.
  - 15 watts maximum audio power, 90 ma d-c maximum primary current. 2500 to 13,000 ohms primary impedance to 4, 6, 8 and 15 ohm voice coils.

Note: All windings to terminate in 3 inch wire leads except voice coil windings, which will have terminal lugs. Power transformers to be core and coil construction. Universal mounting brackets to be available as separate item. Audio transformers and choke to be open channel frame construction.

## REPLACEMENT COILS

### A. Antenna and R-F Coils

Compact universal type coils with adjustable iron core and without shield cans to be available.

### B. I-F Transformers.

- 456 kc. cartwheel type, with trimmer
- 175 kc, standard type in shield, 1 1/4 sq. by 2 1/2 high
- 262 kc, standard type in shield, 1 1/4 sq. by 2 1/2 high
- 456 kc, standard type in shield, 1 1/4 sq. by 2 1/2 high

### C. Slipover Primaries.

Units with following O.D.'s to be available:  
1/2 in.; 3/4 in.; 1 in.; 1 1/4 in.

### D. Oscillator Coils.

Unshielded adjustable iron core coil with inductance of approximately 90 to 220 microhenries to be available, so as to be suitable for all i-f frequencies from 175 to 470 kc with usual tuning capacitors.

## SERVICING NOTES

### Trouble in . . .

#### PILOT PORTABLE RADIOS

On Pilot portables, the complaint may be a bad hum. Immediately you think it is a poor filter condenser because of pronounced hum. On these radios, the aerial is attached to the back of radio and connected to chassis by means of a 3-pin plug. Tighten female prongs on aerial because

hum is due to poor contact causing open grid on r.f. tube.

VITO F. DAIDONE,  
Newark, N. J.

#### BUICK 1940-1941 CARS

Complaint of intermittent reception, static, no reception. Before removing receiver from car, check built-in aerial above mirror. Some you will find have shorted

aerial lead, others have corroded joints, and others poorly assembled at factory.

VITO F. DAIDONE,  
Newark, N. J.

#### RCA MODEL K80

In this model if whistling exists on the high and low frequency end of the dial, try

(Continued on page 309)

# LENZ' LAW IN MODERN SPEECH

By FRED SHUNAMAN

*Mr. Shunaman started to give a little theory as an introduction to his article on transformer design, but it was found better to filter the theoretical and practical into two separate articles. This is the theoretical half.*

GET a magnet—a strong bar-magnet if possible. Wind a coil of No. 20 or bigger wire—12 to fifty turns, the more the better. A drinking glass is a good form. Slip it off and bind it in a few places with string or twisted wire. Attach the ends to a 1 MA meter (lower-reading, if you have it). You are now ready to prove that "If a magnetic field is made to cut an electrical conductor, a voltage is set up in that conductor." This is one of those experiments that always go off according to Hoyle. Simply shove one pole of the magnet vigorously into the coil, and you will see the needle flick. If it doesn't move enough to satisfy you, use more turns of bigger wire, or use a good magnet next time. See Fig. 1 for the setup.

While we have our set-up we can note

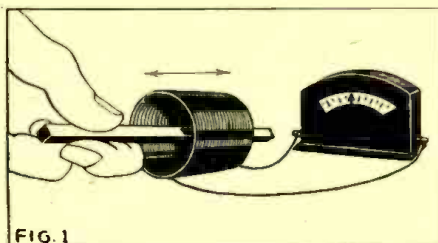

FIG. 1

that the strength of the current is varied by a number of factors: Speed of cutting (push the magnet in faster); Number of conductors cut, (use a coil with more turns); Strength of field, (a weaker magnet, or same relative motion nearer to and further from the coil).

Note also that only axial motion of the magnet (which causes the field to strengthen and weaken) causes current. Sideways or circular motion inside the coil has no effect.

So now we know how to make electricity.

We know also that passing a current through a coil of wire sets up a magnetic field around it—having played with magnets, doorbells and relays enough to make no experiment necessary. If any of you haven't, go out and buy a doorbell and a dry cell to operate, and you will learn some things about magnetism you probably never got from the textbooks.

Now—someone is bound to ask—if a magnetic field sets up a current, and a current sets up a magnetic field, does the current set up by the magnetic field set up a second magnetic field, and how do you tell the two fields apart?

Exactly this does happen, and it is the second most important thing in magnetic induction. A second magnetic field is set up and this field is always in such a direction as to oppose the first field. To prove this, get a compass and check on the direction of the magnetic field when the magnet is thrust into the coil.

Now hook up a dry cell and a 2,000-ohm resistor (to avoid burning out the meter) in series with the coil and meter as shown in Fig. 2.

When you get the meter reading in the same direction, try the compass in the coil and note that the North end of the needle is pointing in the opposite direction to that of the field required to produce a current flowing the same way.

This explains, among other things, where we get our current. We know that nothing is gotten for nothing in this world of conservation of energy, but our current seems to come from nowhere.

Really, when we push the magnet into the coil, the current set up in it produces a field which pushes back at us—tries to shove the magnet back out of the coil. We have to use more energy to drive our magnet into the coil than we would if no current were flowing; and it is this energy which is converted into the electric current that shows on the meter.

Knowing these two laws: 1.—Electric force is set up in a conductor when cut by strengthening or weakening magnetic fields, and 2.—When such field sets up current in a closed loop, the current sets up a second field which opposes the first—we are ready to see what makes a transformer go.

## TRANSFORMERS

A transformer consists of two coils of

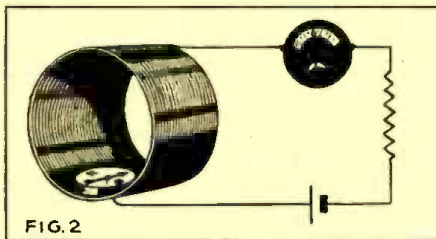

FIG. 2

wire wound on the same iron core, so that a current passing through one coil sets up a magnetic field which cuts both coils equally. The iron core provides an easy path for the magnetism, which is at least several hundred times as strong as if no iron were there, and may, in good transformers, be several thousand times as strong.

Look at Figure 3. C is an iron core coil. The primary is connected across a 115-volt, 60 cycle, A.C. line. For convenience in calculating, we will wind "Pri" with 115 turns of wire. Since our line is A.C., the current is changing direction 120 times a second, and 120 fields, (60 in each direction) are set up around it in that time. These fields set up counter voltages, (or attempted

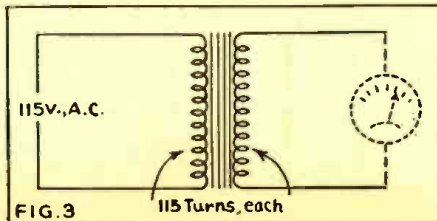

FIG. 3

counter-currents) which because of the strong fields due to the iron core, are strong enough to buck out the impressed line voltage so successfully that little current flows in the coil—only enough to magnetize the core.

Now let us look at the secondary coil, to which the meter is connected. This coil also has 115 turns, and as it is cut by the same field as coil "Pri" we should expect it to have the same voltage. In both primary and secondary there is one volt across each turn.

If we had only 60 turns on the secondary we would get 60 volts, and if we need a voltage of 500, all we have to do is to wind the secondary up to 500 turns.

So far, we have had no current in our secondary coil (except the negligible

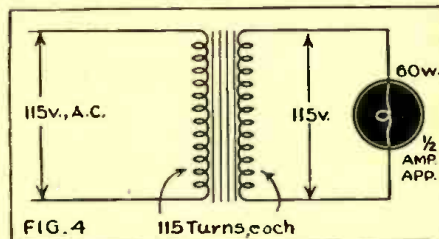

FIG. 4

amount drawn by the voltmeter). With no current, the secondary has set up no magnetic field.

Let's hook up a 60-watt lamp in place of the voltmeter, Fig. 4. This time the secondary draws one-half ampere at 115 volts; and according to Ohm's Law, has an impedance of 230 ohms. An ammeter inserted into the primary would show that it is also drawing the same current (plus a slight amount lost heating up the transformer).

This is what is going on: While the secondary was open, the magnetic fields set up as each half-cycle of A.C. was trying to force its way through the primary, were so strong that the counter-voltages or counter-currents bucking against the line were great enough to practically prevent flow of current in the coil.

As soon as current starts to flow in the secondary, it sets up a field opposite in direction to the field set up by the current attempting to flow through the primary. This field weakens the primary field to such an extent that more current can flow in the primary. When enough primary current flows to build the magnetic field up far enough to cancel out the effect of the secondary field we again have a steady condition, and no more current flows.

The heavier the secondary current, the stronger the bucking field, and therefore the bigger the primary current.

The whole thing is automatically balanced. A transformer permits just enough primary to flow to supply the needs of the secondary, or load circuit. This self-regulating feature is tremendously valuable, and is

(Continued on page 318)

# THE SUPER T.R.F.-NINE

By RALPH W. MARTIN

*Experimentally-minded readers will welcome Mr. Martin's latest "Mystery Receiver," now grown to a nine-tube set. In presenting this latest version of the set which caused much controversy in the past, we can guarantee nothing, except that it may start another flood of "Mystery Receiver Correspondence."*

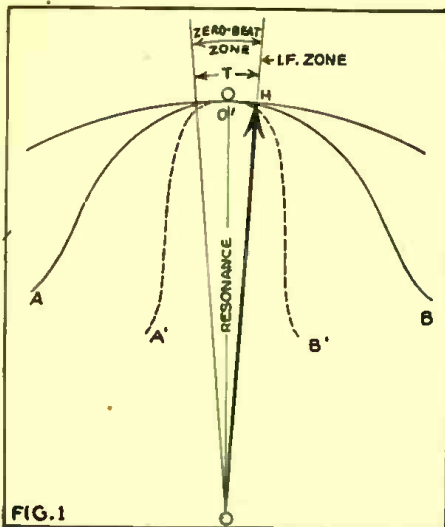

Resonance with zero-beats.

**T**HE Super TRF Circuit was first presented as a one-tuber in *Radio & Television* last year.

Since that time the writer has experimented continually with the main ideas involved, in the hope that some of the fundamental principles underlying the operation of the circuit would bloom forth in some semblance of perfection.

After developing the idea to the present stage of a nine-tube set, full success is still a little way around the corner because a thoroughly efficient oscillator-mixer tube has not yet been found.

In the present nine-tuber, as shown by the diagram, practically all of the former obstacles that hindered the development of both the R.F. and A.F. amplifiers have been overcome. With two 6K7s in the R.F. portion and a well developed A.F. amplifier, there is no lack of amplification. There is also no reason why other types of A.F. amplifiers should not serve as well.

The fly in the ointment is the oscillator-mixer tube, for to date, no tube has been found that will furnish a sufficiently high enough oscillator current that will fully orthodyne (oscillator frequency same as R.F. frequency), with the incoming signal, and at the same time furnish the high

selectivity which the theory of the circuit promises.

However, in case any experimenter should become interested in this circuit in a practical way, we furnish some construction information, and a list of parts.

Coils A and B are Miller 242-RF coils. Coil C is also a Miller 242-RF but altered so as to act as an oscillator coil. To do so, first disconnect the primary coil which is wound on a bobbin placed within the coil form. Next, make a cylindrical sleeve of stiff paper which will just fit over the secondary. Upon this sleeve, and in the center of the secondary, wind a solenoid consisting of 52 turns of No. 28 enameled wire. The wire must be wound in a right hand helix and be perfectly spooled, with no spacing. The leads should then be connected to the "P" and "B" soldering lugs of the coil form.

All coils should be shielded in cans—even tomato cans can be used.

### THE TUNING SYSTEM

The response curve produced by the first stage of tuning is bound to be quite flat. Such a response curve is shown in Fig. 1 by the full line AOB. It is not drawn to scale nor intended to show the actual shape

of the curve; but to illustrate what follows:—

Fig. 1 represents a tuning dial in which the dial is fixed and the index hand is attached to the shaft of the tuning condenser.

The action may be traced as follows:

When the station under consideration is accurately tuned-in, the index hand will be placed in coincidence with the line marked "resonance". At this position, both tuning circuits will be tuned to the same frequency—the signal and the oscillator current will be in phase, and will be added together arithmetically, and produce a zero-beat current in the 6K7 oscillator-mixer tube.

We will now consider what happens as the station is slowly tuned out in a clockwise direction. It will be found that when the index hand is moved back and forth through a small arc, marked "T" on Fig. 1, the volume of the output will not be affected until the hand immediately passes a point marked "H" on the illustration.

Let us first learn what is happening during the movement of the hand through the arc "T". As this arc is very small and is close to the point of resonance, the fre-

*(Continued on page 318)*

Schematic circuit of the super T.R.F.-Nine.

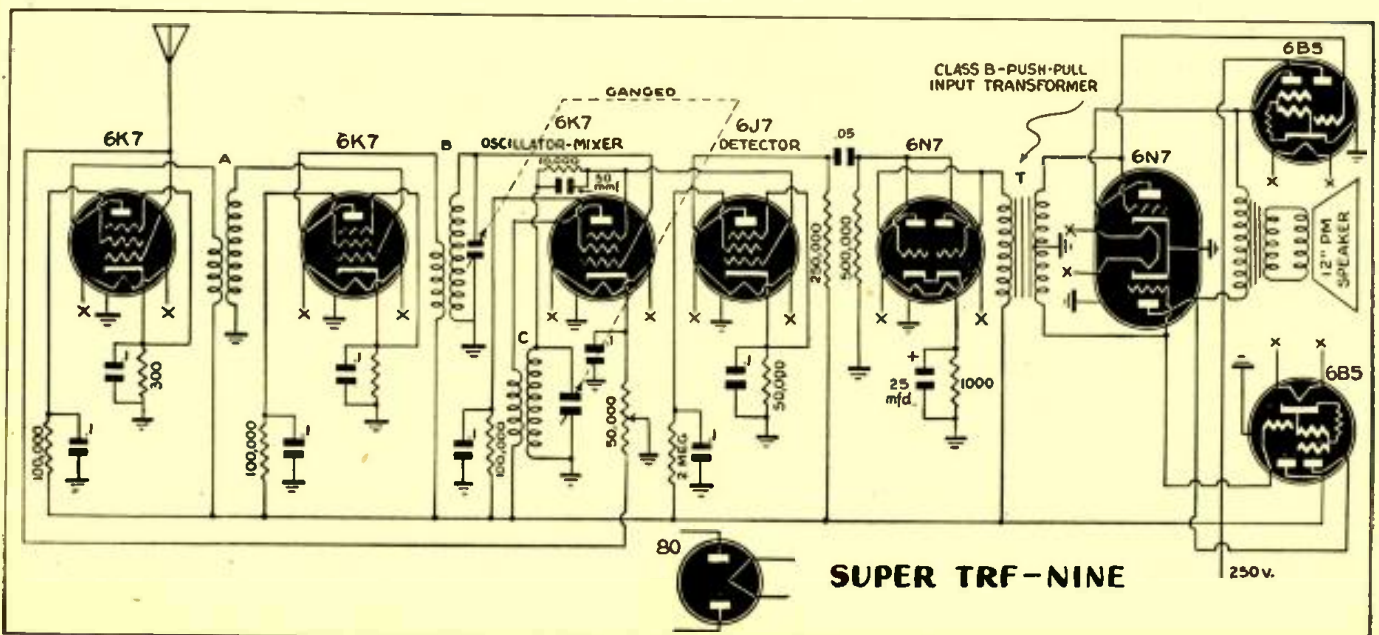

# A REAL PHONO OSCILLATOR

By F. E. MARSH

**T**HIS phonograph oscillator was designed with two thoughts in mind, and equal consideration was given (1) improving on previous designs, and (2) compacting the design as much as possible. In improving the design, a real effort was

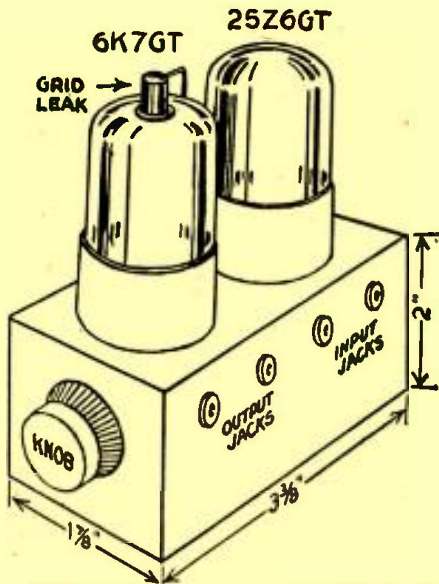

Compact arrangement of the high-powered phono oscillator. The connecting jacks are on the side. Note that the arrow indicates grid leak, not grid leak.

made toward gaining most satisfactory performance.

## RIPPLE MODULATION

Noticeable in many designs now on the market is a considerable ripple modulation which spoils record reproduction for the discriminating listener. Since this phonograph oscillator is designed to operate on alternating current (available in the majority of homes) as well as on direct current, the plate supply should be obtained from a full-wave rectifier. This is imperative in the case of phonograph reproduction in the 25 cycle districts for the ordinary half-wave supply is useless there.

Ordinarily, a full-wave rectifier means a power transformer with a center-tapped secondary; but remembering that the oscillator is to be as compact as possible, some substitute for a transformer must be found.

Transformers are expensive, and difficult to obtain nowadays but a satisfactory substitute for a center-tapped secondary is a center-tapped resistor (or two resistors of the same value in series). This readily yields the midpoint of the alternating current supply. Two 3,000-ohm, 1-watt resistors are used.

Two considerations were balanced against each other in determining the proper value of these resistors. The resistance should be the maximum value (in order to keep down wattage requirements, and hence size) which is compatible with the allowable voltage drop which will be caused by the oscillator plate current flowing through these

resistors to the rectifier plates. A simple computation will give the wattage requirement:

$$W = \frac{E^2}{R}$$

$$\text{Power Loss} = \frac{(110)^2}{6,000} = \frac{12,100}{6,000} = 2 \text{ watts}$$

Two 1-watt resistors in series will successfully dissipate this small loss.

The plate current of the 6K7GT oscillator is approximately two milliamperes. This will cause a drop of:

$$E = IR$$

$$\text{Drop} = .002 \times 3,000 = 6 \text{ volts}$$

The output voltage of this rectifier when operated on A.C. will be approximately

$$\frac{110}{2} \times \sqrt{2} = 78 \text{ volts full-wave. When}$$

operated on D.C., the output voltage will be about 55 volts. This is more than ample, since the 6K7GT operates efficiently with only 30 volts on the plate.

The 6K7GT is used as a suppressor-grid-modulated oscillator. Cathode regeneration is employed. This allows the use of a single-winding coil (L1), home built, consisting of 85 turns of #32 enameled wire, close-wound on a 1" diameter tube. This coil is tapped at 20 turns for the cathode; a trimmer condenser, 75 to 350 mmfd., is shunted across the coil, and can be varied to produce oscillations over most of the broadcast band. This wide range should include at least one "quiet spot" in any locality.

The "tank coil" of the oscillator (T1), is untuned; it consists of a simple 80 millihenry R.F. choke. Coupling to the receiver is effected by a 10 turn secondary of #30 single silk covered wire wound on the choke.

The two leads from this secondary go to the output jacks, which are connected to the receiver antenna and ground connections respectively. This is generally more effective than depending on the radiations from a short length of wire connected to one of these output jacks.

The plate voltage to the oscillator is adjusted by means of a potentiometer volume control, R<sub>6</sub>, to 30 volts; if no high-resistance voltmeter is available to check this, the control may be set at its midpoint. The plate voltage is not critical, but it should be kept at the minimum value compatible with good reproduction in order to keep down radiation of interfering oscillations.

The other potentiometer volume control, R<sub>5</sub>, connected to the suppressor grid varies the percentage modulation. This control likewise should be set at the minimum position which gives good volume. Too high a modulation voltage applied to the suppressor-grid will result in a distorted signal.

## GENERAL CONSTRUCTION NOTES

The heater resistor, R<sub>8</sub>, is most conveniently incorporated in the line cord.

A midget choke of about 7 henries inductance is used in the power supply filter. A resistor could be used to save a small amount of space; but this would result in considerable hum, defeating one of the prime considerations of the design.

Obviously, minor variations may be substituted without affecting the operation of the circuit. For instance, other sizes of wire, or insulation types may be substituted if the kinds specified are not available.

## OSCILLATOR

The oscillator circuit is a standard one, and has been published before. However, the builder of this phonograph oscillator will be rewarded with superior record reproduction

(Continued on page 301)

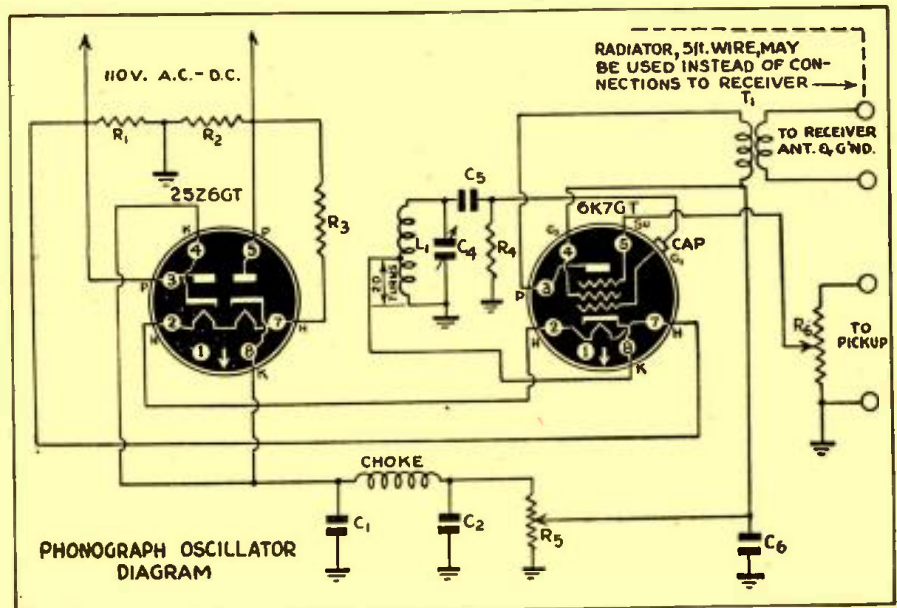



# A SIMPLIFIED ELECTRONIC VOLTMETER

By HAROLD DAVIS

## PART II

THE electronic voltmeter was introduced to the radio service industry on a large scale by means of the signal tracers, most of which incorporate such an instrument. Unlike the vacuum tube voltmeters used previously, the electronic meter does draw a small amount of current from the circuit, and is not free from frequency discrimination. In fact, the more popular instruments are for D.C. measurements only, and it is for this purpose that the servicemen need it most. The amount of current drawn is negligible, even when measuring bias cells.

Fortunately, the D.C. meters will read signals in the audio end of the radio. These signals are not alternating but instead they are pulsating. The detector has rectified them and all they need is a little filtering

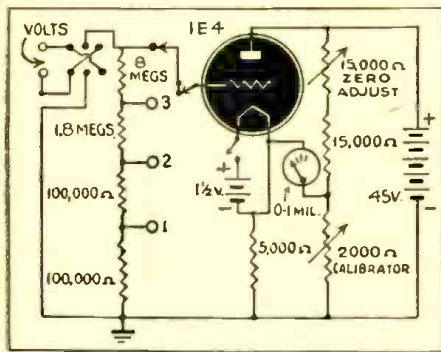

Circuit diagram of the simplified electronic voltmeter. The switch shown near the tube is not necessary, but the switch shown on the top tap (No. 4) is. It can be moved from this tap to Nos. 3, 2 and 1, as described in the text.

before they are fed to the electronic meter. This filtering is taken care of automatically in the one meg resistor used in the probe tip of the test lead to isolate the instrument from the signal source to prevent interference with the operation of the circuit under test.

The instrument shown here differs from most of the electronic meters on the market in that it is battery-operated and permits full-scale reading. The battery operation offers several advantages. To begin with only a small amount of plate voltage (45 volts) is required, and with the small 45-volt packs available in some localities, the size of the instrument does not have to be increased to incorporate battery space. Battery operation offers stability not obtainable with any type of line-operated meters. And because voltage regulation has a direct relation to calibration, this is highly important.

However, the deciding factor in designing the instrument for battery operation is to permit the use of the left-hand zero position instead of the zero center, which in turn gives more than twice the scale length.

The reason a left-hand zero cannot be used with a line-operated meter without a complicated circuit is because when the test prods are reversed (to read grid and A.V.C. voltages) the ground of the instrument is tied to the grid or the A.V.C. network, thereby short-circuiting it through

the mutual line connection. Also hum and other interference is caused when grid circuits are contacted.

With the battery-operated meter, the leads may be switched at will without causing any interference. A polarity reversing switch has been incorporated to speed up this operation. As an isolating resistor of one megohm is built into one of the test prods, the use of this switch keeps the isolating lead contacting the potential, whether it is positive or negative.

This is important because when contacting a diode, for instance, an ordinary test lead will detune the circuit badly, even though the other end is not connected to anything. However, if the isolating resistor is used, and the hand grips the probe behind the resistor, no detuning will occur.

The circuit shown in the diagram is almost self-explanatory and if followed closely will require no tinkering. It is a bridge type, with the 15,000-ohm resistor and the 15,000-ohm control which is the "zero" set, forming one leg, and the resistance of the tube the other. The 2000-ohm calibrating control forms the third leg, while the 5000 resistor in series with the filament and ground the fourth.

Incidentally, this resistor does the work as a cathode bias resistor does. The plate current flows through it, forming a bias voltage. This circuit is unusual and eliminates the necessity of biasing the tube with batteries. When a voltage is applied to the grid, the tube resistance is changed, upsetting the bridge and permitting the current to flow through the meter.

The voltage divider totals ten megohms. Any size can be used, but this value is very satisfactory. The meter reads full scale, when a potential of three volts is applied through the one meg isolating resistor in the test probe. The input voltage is always applied across the multiplier, which drops the voltage applied to three volts or less before it reaches the tube grid. The tube pulls no current and the size of the resistors can be calculated using Ohm's Law, without the tube being given consideration.

For example, to read 15 volts on the meter, 12 volts must be dropped across the first tap on the divider. To find the size of this tap, the total current that flows through the 10 megs when a potential of 15 volts is applied, must be known; that is:

$$I = \frac{E}{R} = \frac{15}{10,000,000} = 0.0000015 \text{ amp.}$$

with leads shorted, and a full-scale reading obtained when the voltage is applied.

Sometimes the meters will have a tendency to read "up" when no voltage is applied. This is especially true when poorly insulated test leads are used. If good leads are used and such trouble develops, see that the grid leads are not close to or touching other wires, especially plate supply leads. It should also not touch the chassis.

If the other scales do not track, the multiplier resistors are not correct, and their values should be checked carefully, with a very good ohmmeter.

# SPRAYBERRY RADIO TRAINING FULL EQUIPMENT

includes Experience Easily Acquired at Home

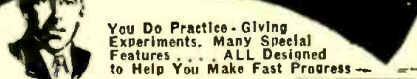

You Do Practice - Giving Experiments. Many Special Features - ALL Designed to Help You Make Fast Progress -

SPRAYBERRY Training starts right at the beginning of Radio - unfolds each subject in a simplified, logical, understandable style. You easily learn Television, Frequency Modulation, Signal Tracing, Mobile Radio (Auto-Tank), Aviation Radio, Electronics, Facsimile Radio, Radio Set Repair and Installation Work.

Training Prepares You for a Business of Your Own - or Good Radio Jobs - Civilian or Military

The important and fascinating field of Radio offers many opportunities to the man who wants to get ahead. My Training will help you win quick promotion in the Army or Navy - will fit you for a bright Civilian career. SPRAYBERRY Methods are thorough and practical. Your Training will not interfere with your Present duties. No previous experience is needed.

You Get a Dual-Purpose Radio Set I supply you with Radio Parts which you use to gain pre-experience in Repair work. These same Parts are used as a Modern Signal Generator and for Signal Tracing, etc. You'll find my Course and Equipment fully described in the catalog offered below.

Earn While You Learn My BUSINESS BUILDERS show you how to put your equipment to actual use in handling money-making Radio Service Jobs shortly after you begin Training.

THE SPRAYBERRY COURSE IS SOLD UNDER MONEY-BACK AGREEMENT

RUSH COUPON for BIG FREE BOOK

SPRAYBERRY ACADEMY OF RADIO  
F. L. Sprayberry, President  
620-B University Place, N. W.  
Washington, D. C.

Please rush my FREE copy of "HOW TO MAKE MONEY IN RADIO."  
Name ..... Age .....  
Address .....  
City ..... State .....  
(Mail in envelope or paste on penny postcard)

The Book that takes Drudgery out of Mathematics

Only 50¢ postpaid

SOLVES EVERYDAY PROBLEMS - HELPS YOU GET AHEAD IN LIFE

How many times have you lost money because of a mistake in figuring? Do you know how to figure quickly and correctly? Can you figure discounts, interest rates, taxes and all the other calculations you meet up with in your daily life?

Are you having trouble qualifying for Army or Navy promotion because you're not up on mathematics?

Here is the book that gives you a good background in mathematics; that takes all the irritation and drudgery out of it. You don't need to be scared of mathematics, because here's the subject explained without frills, without useless computations.

Here's the book for men in the armed forces; for business men; technicians and craftsmen, explaining and answering everyday mathematical problems in easy-to-understand words and illustrations.

Yes, it's the key to a simple understanding of mathematics. It's a real home-study course in mathematics for the man who's alert to the importance of mathematics in the world today.

## ELEMENTARY MATHEMATICS

• EASY - SIMPLIFIED - PRACTICAL •

CONTENTS OF BOOK

- CHAPTER I. Arithmetic—Addition—Subtraction—Multiplication—Division.
- CHAPTER II. Factoring and Cancellation—Fractions—Decimals—Percentage—Ratio and Proportion.
- CHAPTER III. The Metric System.
- CHAPTER IV. How to Measure Surfaces and Capacity (Geometry).
- CHAPTER V. Powers and Involution—Roots and Evolution.
- CHAPTER VI. Mathematics for the Manual and Technical Craftsman—Thermometer Conversions—Graphs or Curve Plotting—Logarithms—Use of the Slide Rule.
- CHAPTER VII. Special Mathematics for the Radio Technician.
- CHAPTER VIII. Commercial Calculations—Interest—Discounts—Short Cut Arithmetic.
- CHAPTER IX. Weights and Measures—Useful Tables.

Send Stamps, Cash or Money Order.

Send today for your copy of this indispensable book. It can be carried readily in your pocket. (Size 6 1/2 in.)

TECHNIFAX  
1917 S. State St., RC-243, Chicago, Ill.

# USING THE OLD METER

By JOHN R. KEARNEY

*To many servicemen the data presented here may be nothing new. On the other hand to those who never bothered to figure an ohmmeter circuit, the information may be useful*

**M**OST articles have something to say about using the old bean, meaning the intelligence, but we are going to be different and get off some remarks on the metering situation. These days it is not strange, perhaps one might say it is even common, to find that the old Jewell or Weston is being dusted off and put back in service. There are plenty of these old

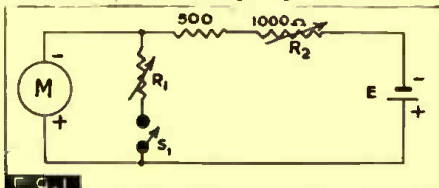

meters around that are almost as good as the day they were put up there on the shelf and forgotten.

Take for example the 0-1 millimeter that has no ohms scale on it. It is possible to open the meter up, and put a special scale on it, using India ink for the purpose. But in general the preferred course to follow is to use a separate calibration chart. This will

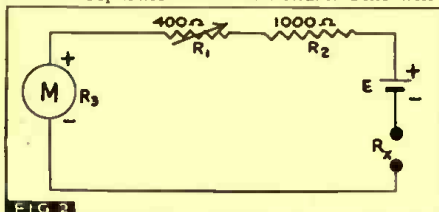

give greater accuracy, due to its large size, and to the fact that the meter movement will not have been disturbed, nor any dust or stray particles gotten into the movement to cause error.

### FIRST STEPS

In many cases the internal resistance of the meter is not known; yet it must be known in order to set up the calibration chart. Under such conditions the resistance must be found experimentally.

As most 0-1 ma. meters have a resistance between 20 and 200 ohms, we can use the circuit shown in Fig. 1. The first step in

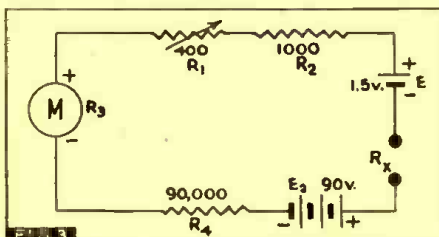

using the circuit is to close  $S_1$  and adjust  $R_2$  for full-scale deflection on the meter. Then,  $S_1$  is opened and the meter is adjusted for half-scale deflection by means of  $R_1$ . The currents in the meter and in the rheo-

stat are then the same, and the resistances are the same.  $R_1$  is then measured with an ohmmeter, switch  $S_1$  being opened. If  $R_1$  is a calibrated rheostat of the laboratory type, the resistance can be read off the calibration scale directly.

Let's assume that the resistance of the meter has been established as 100 ohms. How can we use it as an ohmmeter? From Fig. 2 we see that the current that flows in the circuit will be equal to

$$I = \frac{E}{(R_1 + R_2 + R_3 + R_x)}$$

If we assume that  $E$  is a 1.5 volt cell which measures exactly 1.5 volts, the total circuit resistance will be

$$\begin{aligned} & (R_1 + R_2 + R_3 + R_x) \\ &= (400 + 1000 + 100 + R_x) \\ &= (1500 + R_x) \text{ ohms} \end{aligned}$$

$I$  (current through the meter in amperes) =  $\frac{1.5}{(1500 + R_x)}$

And solving for  $R_x$ :

$$R_x = \frac{1.5}{I} - (1500)$$

To make  $I$  read in milliamperes, we have:

$$\begin{aligned} R_x &= \frac{(1.5)(1000)}{(\text{Ma.})} - (1500) \\ &= \frac{1500}{\text{Ma.}} - (1500) \end{aligned}$$

From this we obtain the general formula:

$$R_x = \frac{(E)(1000)}{\text{Ma.}} - (R_1 + R_2 + R_3 + R_x)$$

We can calculate a number of current values and then draw a graph of the relationship, obtaining intermediate values in this way. Let's start by assuming a current of near maximum value, .9 ma. We then have:

$$\frac{1500}{.9} = \frac{15000}{9} = 1665 \text{ ohms}$$

and  $1665 - 1500 = 165$  ohms for the lowest value.

The lowest current is, let's say, .1 ma. Then,

$$\frac{1500}{.1} = 15000 \text{ ohms}$$

$15000 - 1500 = 13,500$  ohms which gives us the higher limit.

### EXTENDED RANGES

If we wished to extend the range, we could use an additional battery as shown in Fig. 3. The formula would be worked out as in the previous example, giving:

$$R_x = \frac{91,500}{\text{Ma.}} - 91,500$$

Assuming a current of .1 ma. we would have 823,500 ohms for  $R_x$ .

If we obtained 300 volts from a power supply, as shown in Fig. 4, the ohmmeter range would be extended to 2,713,500 ohms.

If the meter on hand happens to be an

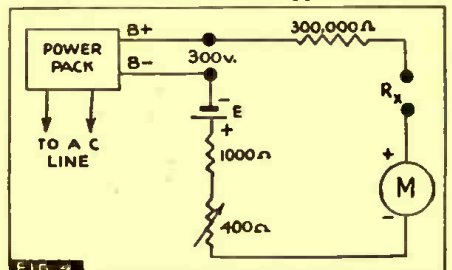

FIG. 4

0-500 volts type of 1000 ohms per volt rating, or full scale current of 1 ma., the circuit of Fig. 5 can be used to make it serve as an ohmmeter for reading high resistances. If the meter has a current scale on it, the current in milliamperes can be divided into 300,000, and 500,000 can be sub-

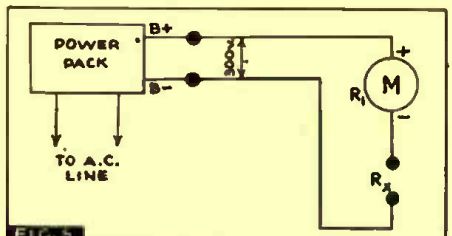

FIG. 5

tracted, being respectively the source voltage times 1,000, and, the meter resistance.

Another method is to check the supply voltage, getting  $V_1$ .  $R_x$  is then inserted, giving a reading  $V_2$ . The difference is  $V_3$  and this difference voltage divided by  $V_2$  and multiplied by the meter resistance (500,000 ohms in this case) gives the value of  $R_x$ . If  $V_2$  is 50 volts, the current will be .1 ma. and the value of  $R_x$  is 2.5 megohms.

### LOW RESISTANCE OHMMETERS

In Fig. 6 a circuit is shown for the

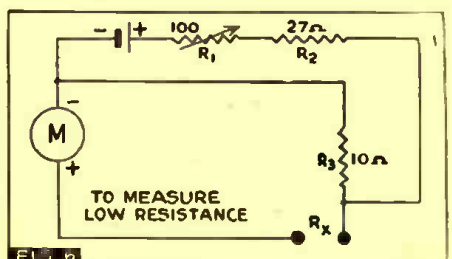

FIG. 6

measurement of low resistances. When  $R_x$  is present it is in series with the meter. Since  $R_3$  is 10 ohms and is 1/10th the resistance value of the meter, ten times as much current will go through the shunt as through the meter when  $R_x$  is zero. For other values

# Radio School Directory

TO OUR READERS

NOW, more than ever before America needs trained radio men. The Army, the Navy and the Air Force are continuously on the lookout for men who have had training in radio. Scores of war industries require radio men in various capacities throughout the country. There now is and there

will be a great shortage of radio men for years to come. NOW IS THE TIME TO TAKE UP RADIO.

The leading radio schools listed in these pages are training thousands of men in all branches of radio. We suggest that you read their advertisements carefully.

## • TODAY is the time to turn your RADIO JOB into a SECURE POSITION!

Do You Want a BETTER JOB?—A Secure Future? NOW is the time to prepare yourself for a lasting, profitable Career in Radio Engineering!

Don't fool yourself! The good jobs—the permanent positions in radio don't come easy. The jobs that come easy, are not easy to hold. The sure way to success is to build your future on a sound foundation of knowledge and ability . . . and the ability that you develop now is your assurance of a steady, sure income and a permanent job that will outlast the temporary employment conditions that exist today. Dividends for increased ability have never been so certain, as the radio and electronics industries look to the future.

CREI technical training is designed to do just one thing—to increase your ability, enabling you to hold the more responsible positions which lead to higher salaries. Hundreds of CREI students have accomplished this through the help of CREI training—just as many more hundreds will do in the future!

### • WRITE FOR FREE 32-PAGE BOOKLET

If you have had professional or amateur radio experience and want to make more money—let us prove to you we have something you need to qualify for a better radio job. To help you intelligently answer your inquiry—please state briefly your background of experience, education and present position.



### CREI Students and Graduates — ATTENTION!

The CREI Placement Bureau is flooded with requests for CREI trained radiomen. Employers in all branches of radio want trained men. Your government wants every man to perform his job, or be placed in a job that will allow him to work at maximum productivity. If you are or will be in need of re-employment write your CREI Placement Bureau at once.

## CAPITOL RADIO ENGINEERING INSTITUTE

Home Study Courses in Practical Radio Engineering for Professional Self-Improvement  
Dept. RC-2, 3224-16th Street, N. W. WASHINGTON, D. C.

Contractors to the U. S. Signal Corps—U. S. Coast Guard  
Producers of Well-trained Technical Radiomen for Industry

## RADIO

PRE-MILITARY TRAINING for MEN of MILITARY AGE



CIVILIAN TRAINING for MEN and WOMEN seeking Careers in Radio  
Complete Course up to 8 Months

Write, Phone or Call 9 a.m. - 9:30 p.m.

METROPOLITAN TECHNICAL SCHOOL

RADIO DIVISION DEPT. R

7 CENTRAL PARK WEST, N.Y.  
Circle 7-2515 Licensed by State of N.Y.

## Coming! A NEW WORLD

of RADIO and TELEVISION

What Part Will You Play In It?

(An Opportunity for Men and Women of All Ages)

• War has accelerated the pace of development in Radio and Television . . . has opened up unheard-of fields of opportunity for men trained for tomorrow's New Radio and Television careers.

• Here, at Radio and Television Institute, far-sighted men are working together to supply the demand for radio television experts who will be needed to occupy key positions in a new world.

• What about you? Will you invest a small portion of your present earnings—a few hours of your time in a sound future . . . train under experts who have kept pace with every modern development in Radio and Television?

Call or write today! Let us prove to you that a career may be yours—with a little effort and expert guidance.

TRAIN AT

### RADIO-TELEVISION INSTITUTE

Grand Central Palace Building

48th and Lexington Avenue New York City

\*Licensed by the State of N. Y.

### Airlines Need

**MEN—WOMEN**  
as Communication Experts

TRAIN IN  
FEW WEEKS

Become part of today's most exciting profession, with a future that's unlimited. Thousands are needed as communications operators by airlines, railroads, private industry. Prepare now for a better job with big pay.

This work is easy to learn, fascinating, and vital to the nation's war effort.

LEARN TO EARN  
\$30-\$40-\$50 Per Week

At an important communications post you'll be helping America, and getting good pay while doing it. For, if you start your training now, you'll be ready in 10 to 12 weeks to step into this fascinating, big-pay field.

Take advantage of this opportunity now. Write today for full details and low cost tuition. Send a card or letter to . . .

Electronic Radio-Television Institute

Desk 12

2055 Harney St., Omaha, Nebraska

## RADIO COMMUNICATION COURSES

STUDY RADIO BEFORE BEING CALLED TO ACTIVE SERVICE  
Our graduates are now actively engaged as radio operators or instructors in  
U.S. SIGNAL CORPS • U.S. AIR FORCES  
U.S. NAVY • U.S. COAST GUARDS  
Instruction by Federally licensed instructors

AMERICAN RADIO INSTITUTE  
44 EAST 23d ST. NEW YORK CITY



## N. Y. TECH

Courses for Men and Women

Drafting, Shop Math.

RADIO,

Electrical, Welding,

Heating, Oil Burner

Service, Refrigeration,

Air-Conditioning,  
108 Fifth Avenue,  
Corner 16 St., N. Y.  
Chelsea 2-6330



## Words with Wings

Day and night, while humanity toils and sleeps, the voice of aviation sends its words winging through space—always vigilant in that efficient work of communications which means so much to the aircraft of war or peace. Thanks to the foresight of Frank Melville, the school that bears his name is now a dependable source of training for men and women in radio communications for aviation—now more important to the safety and progress of America than ever before!

## MELVILLE

AERONAUTICAL RADIO SCHOOL, INC.  
45 West 45th Street New York City

Training Men for Radio in the Service of  
AIRLINES—ARMY—NAVY—MERCHANT MARINE—  
COAST GUARD—INDUSTRY

## PRE-INDUCTION RADIO COURSES

FOR CIVILIANS AND THOSE ENTERING MILITARY SERVICE

NEW CLASSES NOW STARTING

• RADIO OPERATING • CODE  
• RADIO SERVICING

New York Y.M.C.A. Schools

4 W. 64th Street New York City

## RADIO TECHNOLOGY

RCA Institute offers an intensive two-year course of high standard embracing all phases of Radio and Television. Practical training with modern equipment. Also shorter specialized courses in Commercial Radio Operating, Radio and Television Servicing, and Aviation Communications. For Free Catalog write Dept. RC-43.

RCA INSTITUTES, Inc.  
A Radio Corporation of America Service  
75 VARICK STREET NEW YORK

## MASTER COURSE IN RADIO COMMUNICATION

Fits you for a job, advancement or license examination. Course by A. R. Nilson for home study covers same scope as resident school course. Every Nilson graduate to date has commercial license, or a good radio job.

FREE circular 3-C gives full information. Write today.

MILITARY RADIO SCHOOL, 51 East 62nd St., New York

# The **TRIPL**ETT ELECTRICAL

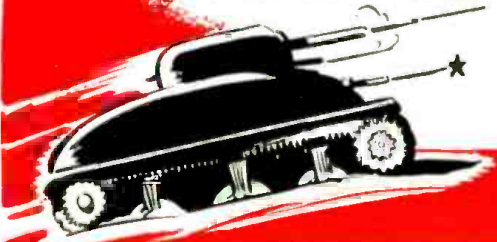

*Passing*

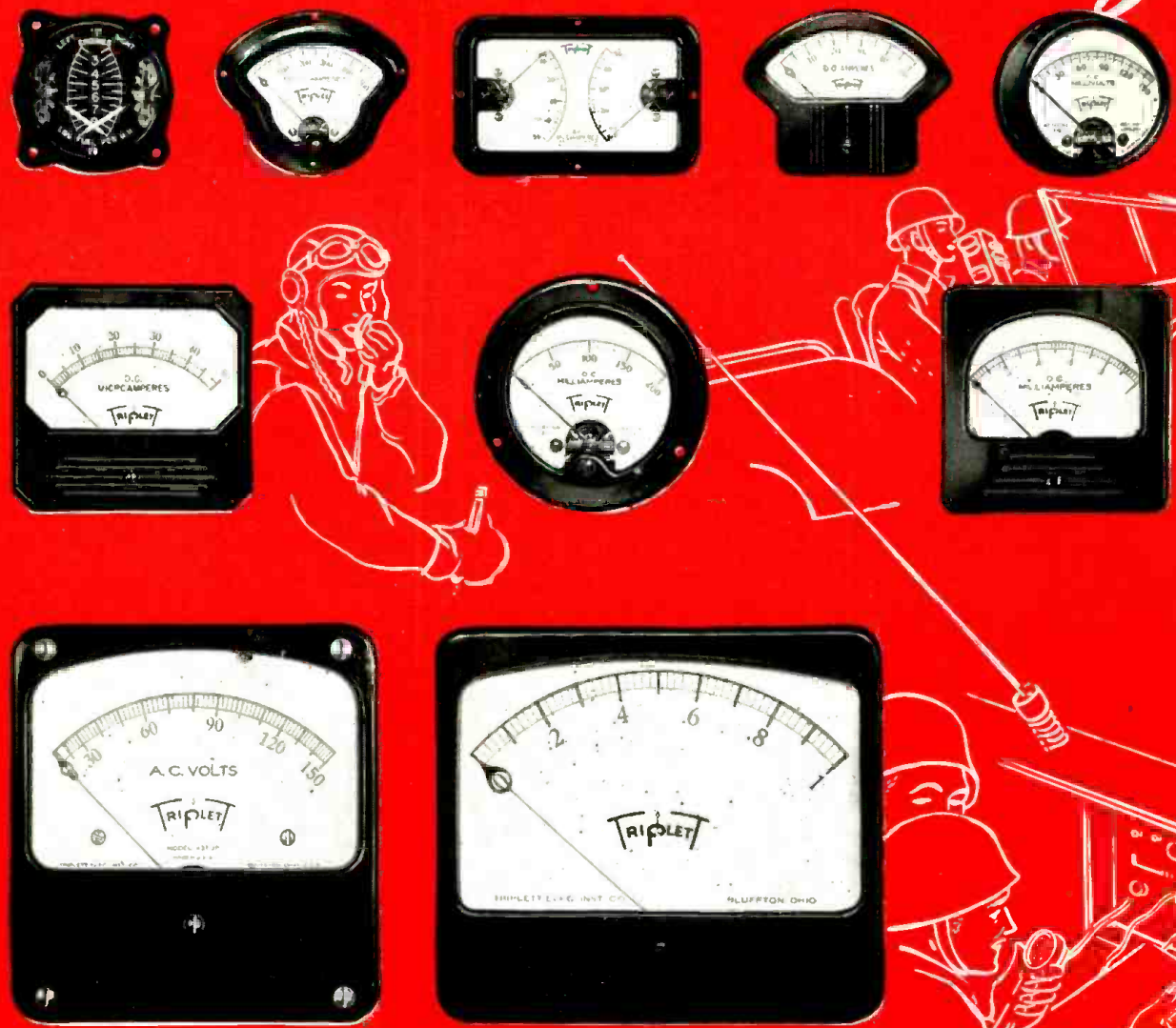

## THE TRIPL

### A WORD ABOUT DELIVERIES

Naturally deliveries are subject to necessary priority regulations. We urge prompt filing of orders for delivery as may be consistent with America's War effort.

# Combat Line

## MEASURING INSTRUMENTS



### *in Review*

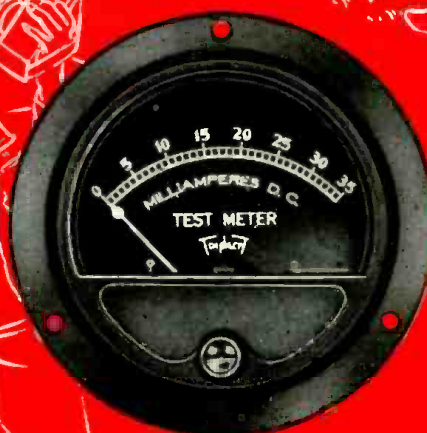
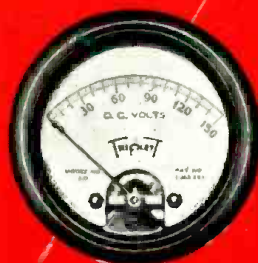

#### A Glimpse into the Future

Out of the needs of war; out of tripled production lines and twenty-four hour days; out of the drive for "better performance under spectacular stress and vibration," comes Triplet precision instruments in volumes impossible by now outmoded peacetime methods. Today our country's needs come first—Tomorrow when America again takes up peacetime pursuits, the values of these experiences will be apparent, in savings, in performance, in technical superiority beyond the concepts of yesterday.

BLUFFTON, OHIO ★ ★ ★ ★



# LEARN RADIO

**EASIER  
BETTER  
FASTER**

**Here's Proof!**

**GHIRARDI'S RADIO PHYSICS COURSE** (the one big 972-page volume that costs only \$5!) is used by more U. S. Army, Navy, and Air Corps, and civilian schools and colleges than any other basic radio textbook published.

**RADIO PHYSICS COURSE**  
—GHIRARDI  
**RADIO PHYSICS COURSE**  
BY ALFRED A. GHIRARDI

**DON'T BE MISLED... Compare Before You Buy!**

Don't buy a "pig in a poke!" No matter what kind of Radio Training you may be offered—see it before you buy it—compare it with what Ghirardi brings you for only \$5! See for yourself how his **RADIO PHYSICS COURSE** volume tops other books and courses to an amazing extent that is instantly obvious upon comparison. You be the judge—and we back your judgment with our 5-day Money-Back Guarantee!

## The Nation's Most Widely Used Basic Radio Training Book

Here, in a single, big 972-page volume, is a miracle of modern radio training—sold at only a small fraction of the price you might expect to pay for such thorough, top-notch radio instruction.

### MORE TRAINING FOR YOUR MONEY

Everything that can be done to make learning radio EASY for you at home in your spare time has been done in this widely acclaimed book—right down to 856 self-testing review questions which help you check your own progress every step of the way.

There is no guesswork when you buy Ghirardi's famous **RADIO PHYSICS COURSE**. You know you'll get complete Radio Training—and get it right, BECAUSE this

same inexpensive book has given more people their basic radio training than any other ever published. What's more, this book is used in more U. S. Army Signal Corps, Navy and civilian schools and colleges than any other. Would you want any better proof than this?

### EASILY WORTH \$50 IF YOU BOUGHT IT AS A COMPLETE COURSE

In short, it is a book that has earned its way to adoption as the text in the most important radio instruction courses in the country today—on its own **SHEER MERITS!** That is why it is just the book to pave your way to better pay, and interesting work in any of Radio's many branches from radio servicing to Aviation, Military, Broadcasting, Manufacturing, Electronics, Public Address and various others.

edge of electricity, without which no radio training could possibly be understandable. Such features are highly important. They are the reasons why thousands of civilians and men studying radio in the armed forces report that Ghirardi's **RADIO PHYSICS COURSE** has made the study of radio easier, more interesting, and more genuinely helpful to them than any other radio book or course they have seen or used.

### 36 COURSES IN ONE

Actually, the volume gives you the scope of 36 different courses in one—packed into an easy-to-follow 972-page book with 508 clear illustrations and 856 self-testing review questions. Best of all, you buy it complete for only \$5—and, even then, you take not the slightest chance. All we ask is that you judge it for five days. Then, if you don't agree fully and completely that it is the course for you, your money will be cheerfully refunded. You cannot lose!

### DON'T GUESS... Ask the Men Who Know!

"I have never seen such a wealth of radio information in one volume. Usually, it is necessary to buy a complete book for one subject which this book covers in one chapter." A. G. Hodgson, Jr., St. Louis, Mo.

"As Radio Instructor for the U. S. Signal Corps, I have never found anything to compare with Ghirardi's **RADIO PHYSICS COURSE**." D. Phillips, Radio Instructor, Winchester, Ky.

"I think **RADIO PHYSICS COURSE** is the most 'down to earth' literary effort on Radio. One who doesn't know a thing about Radio can learn from this edition." E. S. Weiss, U. S. Army, Washington, D. C.

From Edward W. Campbell, Vocational War Training Division, U. S. Signal Corps Reserve, Mississippi State College, Mississippi: "I am an instructor in the Radio Section of this school, teaching the U. S. Signal Corps Reservists. I am also chairman of the outline committee and have adopted the **RADIO PHYSICS COURSE** by Ghirardi as the principal reference textbook for these courses. Copies of the Course Outline have also been sent to other schools at the request of the U. S. Department of Education. In my opinion, the radio students taking this course could not find anything to equal your **RADIO PHYSICS COURSE** book in its complete mastery of Radio."

**RADIO PHYSICS COURSE** starts right at the beginning. It takes no previous technical knowledge for granted. It assumes nothing and explains everything. What other books and courses skim over, it painstakingly explains in detail so that you cannot fail to understand. Also, it contains over 300 pages devoted to the all-essential foundation knowl-

### Going with the Army or Navy?

Think what a knowledge of Radio might mean to you in the Army or Navy—better pay, more interesting duty opportunities for faster advancement! Now, before you "join up" is the time to start getting this knowledge—and the place to start is with Ghirardi's **RADIO PHYSICS COURSE!**



## 5-DAY FREE TRIAL

**RADIO AND TECHNICAL PUBLISHING CO., Dept. RC23,  
45 Astor Place, New York, N. Y.**

Rush me your **RADIO PHYSICS COURSE**.  \$5 enclosed.  Send C. O. D. In either case, if I am not fully satisfied, I may return the book within 5 days of receipt and receive my money back.

Name .....

Address .....

City ..... State .....

Rush free descriptive literature.



**ALFRED A. GHIRARDI**

### OTHER BOOKS BY RADIO'S BEST-KNOWN TECHNICAL AUTHOR

**MODERN RADIO SERVICING** by Ghirardi is the only single book that covers modern Radio testing instruments, troubleshooting and repair procedure completely. It is a complete, 1300-page home-study course on the entire art of radio maintenance and repair, 706 illustrations, 720 review questions. Only \$5 complete. Write for FREE folder.

Ghirardi's **RADIO TROUBLESHOOTER'S MANUAL** is just the book for busy servicemen—the kind that pays for itself on the first job. Contains over 4,697 common trouble symptoms for popular receivers plus hundreds of pages of I F alignment "peaks," charts, tables, tips, and data to help servicemen do almost every repair job quicker and better. Only \$5 complete. Write for FREE illustrated folder.

**ABSOLUTE MONEY-BACK GUARANTEE NO QUESTIONS ASKED YOU CANNOT LOSE!**

the current division will be proportional to the ratio of the branch circuit resistances. The meter branch will be made up of  $R_x$  plus the meter resistance. The simplest way of calibrating the circuit is to insert known values of  $R_x$  by using a calibrated rheostat, and drawing a graph. From the graph intermediate values can then be obtained.

Another method is to assume different values of  $R_x$  and then to calculate the meter current, remembering that the current  $I$  divides inversely as the resistances in the branches. Thus, if the meter branch is 10 times the shunt branch, the meter current will be 1/10th that of the shunt current.

Another form of low resistance ohmmeter is shown in Fig. 7. However, this type takes

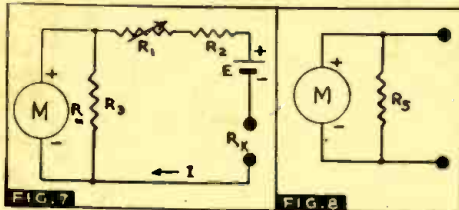

too much current as a general rule and is not very widely used for that reason. Let's assume that the 0-1 ma. meter is to read 0-10 ma. Then 9 ma. must go through the shunt and obviously the voltage across the shunt will be the same as the voltage across the meter terminals. The meter voltage at full scale we know will be 100 ohms times .001 ampere or .1 volt. As this is the shunt

voltage, we have: .1 volt/.009 ampere which gives 11.1 ohms for the shunt resistance. We now multiply the current readings by 10 for we have an 0-10 milliammeter.

Now, for full scale current of 10 ma., using the 1.5 volt battery, we want a resistance of (1.5-.1) or 1.4 and 1.4/.01 which is 140 ohms. Therefore,  $R_1$  could be 40 ohms and  $R_2$  100 ohms. The net shunt resistance, or equivalent resistance of the meter, is  $100 \times 11.1$  divided by the sum of 11.1 and 100, equal to .9 ohm. The total series resistance is then 140 plus .9 or 140.9 ohms and the value of  $R_x$  for a 100 ohm 0-1 ma. instrument is given in Fig. 7 for the different values of current. Remember that the meter is reading 0-10 and the scale values are multiplied by 10 to get each current value. The resistance values are obtained right from the formula for the different current values.

**MILLIAMMETERS**

Milliammeters of different range can be built up from the fundamental range as illustrated in the above ohmmeter example. But to make it clearer, refer to Fig. 8. The terminal voltage of the meter at normal full-scale deflection and current, divided by the extra current the circuit is to handle gives the shunt value. If the circuit is to measure 100 ma., the difference current in the shunt is 100-1 or 99 ma. Then, .099 into the terminal voltage gives the required value of shunt resistance.

The value of resistance necessary in series with the meter to make it read as a voltmeter is given in Fig. 9. Usually the meter

resistance will be small so that it can be disregarded and the required resistance will be simply the voltage  $E$  divided by the current. If  $I$  is in ma. the voltage must be multiplied by 1000 or the current divided by 1000 in using the formula.

The voltage divider system, shown in Fig. 10, is treated as a series-parallel network. For any given value of  $R_2$  the meter circuit will have a net resistance of  $(R_2 \times R_m)$  divided by  $R_2$  plus  $R_m$ . The voltage across the meter subtracted from the source voltage  $E$ , gives the drop across

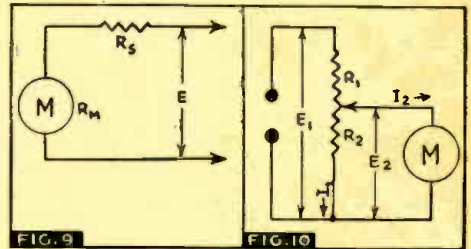

$R_1$ . If  $R_2$  is 1/10th  $R_m$  the current in  $R_2$  will be 10 times the current in  $R_m$  and the opposite holds if the resistances are opposite in ratio. Knowing the series current and drop across  $R_1$ , we divide the current into the drop and get the value of  $R_1$ .

To many servicemen the material presented may be nothing new, while to others who never bothered to figure an ohmmeter circuit the data will be new. But to each it may have some interest and serve as inspiration to dust off some of the forgotten gear.

**WARTIME TUBE REPLACEMENTS**

(Continued from page 279)

**FILAMENT VOLTAGES IN A. C. SETS**

In A. C. sets where filaments are fed off a winding on the transformer, less flexibility is enjoyed. Of course, a 2.5-volt tube could be used by installing a dropping resistor, calculated by Ohm's Law, using the difference between 6.3 and 2.5, or 3.8 for  $E$ , and the current rating of the 2.5 volt tube for  $I$ . The wattage of the resistor is important, because some tubes will require rather high wattage resistors. Some of the 2.5-volt tubes draw as much as 2.5 amperes. Such a tube would require a 25-watt resistor, and of course, the transformer would have to be capable of delivering this extra wattage.

One suggestion is to use high-voltage tubes and install a dropping resistor directly off the 117-volt line. Old A.C.-D.C. line-cords are excellent for making filament voltage-dropping resistors. They will handle approximately 25 watts or more depending on the ventilation. The resistance wire is wrapped on an asbestos base and may be cut off to required length. There are two general types, 30-ohms per foot, and 60-ohms per foot. These old cords should never be thrown away, as they are generally simply broken in one place and the unbroken portions are perfectly good.

**GOING A STEP FARTHER**

It is not out of the question to use battery type tubes in A.C. or A.C.-D.C. sets. In the latter, most circuits use a simple half-wave rectifier with the plates and cathodes of the rectifier tied together. If the cathodes are separated, one can be used to supply the plate voltage and the other to supply the filament voltage for the battery type tubes. Fig. 4 shows the arrangement. The value of  $R_1$  is calculated the same way a line cord is, and all the battery tubes should be placed

in series, and must draw the same current if used in series; or a parallel resistor used on the low current tubes to balance the network as explained previously for A.C.-D.C. sets.

The size of the resistor  $R_1$  of Fig. 4 necessary to drop the filament voltage, should be above 2,000 ohms, and it would be wise to start with plenty of resistance and cut it down gradually, measuring the drop across one of the filaments with a high resistance volt meter. Most of us know from painful experience that these little fellows do not take any foolishness. Just thinking excessive filament voltage will blow some of them.

**TUNED RADIO FREQUENCY SETS**

The modern T.R.F. is simplicity itself. It usually consists of one R.F. amplifier followed by a screen-grid or pentode detector. The screen-grid detector amplifies as well as detects the signal. If the voltages are balanced, practically any R.F. amplifier will work in either the R.F. or detector stage. However, tubes with characteristics similar to the 6C6 are usually used in the detector stage.

The output tube in the T.R.F. is no different from other sets, however the dual purpose tubes like the 50L7s, incorporating output tube and rectifier in one envelope are often encountered. If room is available, two separate tubes may be installed, an output and a rectifier. If room is not available, it may be possible to use one of the duotriodes, using one section for the output tube and the other section with grid and plate tied together for a rectifier. Loss in signal amplification must be expected in the triode output. If a triode-pentode like the 12B8 and 25B8 could be found, satisfactory amplification should result.

**CHANGE CIRCUITS CAUTIOUSLY**

Circuit changes should be made only after a careful study of both the present and proposed circuit. If possible, find a diagram

of a set using the tube to be substituted in the same type circuit, and follow the diagram carefully.

Changes can often be made to good advantage, if the serviceman is sure of himself. For instance, some manufacturers took advantage of contact potential to bias high mu triodes like the 6Q7. Now, contact potential is nothing more than the inherent bias of a tube. In such circuits, a 10 to 15 megohm grid-resistor is used. This gives high amplification, and can often be used to advantage in place of a bias-cell arrangement for biasing.

When used, a coupling condenser of approximately .005 mfd. should be used; a larger size will cause blocking of the grid.

If the serviceman is not sure of himself, he should not hesitate to tell his customer to carry the set to another shop where the required tube or part may be found. It is the serviceman's job to keep the set playing, and he will be permitted many liberties as parts become more difficult to obtain. However, he must never use this as an excuse for sloppy work.

Like all other business men, the radio serviceman must conserve parts. This applies to tubes in particular. No tubes should be replaced unless on actual comparison with a new tube, the new one gives decidedly better quality or performance. No more tubes should be replaced simply because they register weak on a tube-tester.

A tube-tester is a poor piece of equipment, generally speaking. Too often it is about as reliable as a country fair fortune-teller. For while a tube may show up "perfect" on the tester and act poorly in the set, a good tube may show "poor" or "defective" on the tester, and play perfectly, in the receiver.

Therefore double-check the actual results before acting on the readings of the tube-tester.

Save a tube and help keep the supply equitable to all.



**Readrite**  
**RANGER**  
MODEL 432-A

The Outstanding Tube Tester Value . . . .  
Checks all type tubes including Loctals Bantam, Jr., 1.4 volt Miniatures, Gaseous Rectifier, Ballast, High Voltage Series, etc. Filament Voltages from 1.1 to 110 volts. Direct Reading GOOD-BAD Meter Scale. Professional-appearing case with accessory compartment large enough for carrying Model 739 AC-DC Pocket Volt-Ohm-Milliammeter, thereby giving the serviceman complete testing facilities for calls in the field. . . . Model 432-A with compartment. Dealer Net Price . . . \$20.73. Model 432-A in case less compartment . . . \$19.65. Model 739, Dealer Net Price . . . \$18.89.

Write for Catalog—Section 1116 College Dr.

**READRITE METER WORKS, Bluffton, Ohio**

## Speed up REPAIR JOBS

With These Handy 

### SERVICE AIDS

#### New Instant Automatic Wire Stripper

Strips all types of wire instantly, easily and perfectly. Just press the handles. Cuts wire too. Saves time, money and trouble for Radio Men, Electricians, Sound Men, etc. List price \$6.00.



#### Ne-O-Lite Electric Trouble Shooter

Every Radio Man and Electrician should have one. Tests AC and DC lines, DC polarity, blown fuses, etc. Traces ground line in AC circuits. Useful as RF indicator, spark plug and cable tester. Has hundreds of other useful applications. Can be used on 60 volts AC to 500 volts AC or DC. List Price \$1.00.



#### Radio Chemical Laboratory



20 large 2 oz. bottles contain cements, solvents, contact cleaners, non-slip dial chemicals, lubricants, ins. varnish, cabinet stains, glue, coil dopes, etc. Dealer net cost \$4.90 with FREE RACK.

ORDER FROM YOUR RADIO JOBBER

**GENERAL CEMENT MFG. CO.**  
**Rockford, Illinois, U.S.A.**

# PRACTICAL AUDIO AMPLIFIER THEORY

By TED POWELL

## PART 1

*This article is intended to be a lecture type affair in order to present some audio amplifier pointers to newcomers and radio and P.A. men not up on their audio theory.*

IN analyzing amplifier circuits, certain definite types of wave-form distortion must be considered. They will be classified and described here in non-technical fashion in an attempt to clear up some of the confusion that seems to exist in the minds of many radio and P.A. men with regard to this rather important subject.

There are four major types, and perhaps two secondary types, of audio distortion which can be distinctly classified and analyzed. It should be borne in mind that they are more or less inter-related and where conditions encouraging any one of them exist, it will be generally found that correspondingly large amounts of other types of distortion will usually be present. They might be grouped as follows—

### HARMONIC DISTORTION

This type of wave-form distortion is caused by the addition of even or odd-order harmonics or sub-harmonics to the signal frequencies operating through an electrical network. This type of distortion is caused by various circuit non-linearities such as operating on curved portion of tube characteristics; fluctuating plate voltage supplies; circuit components with non-linear amplitude vs. frequency characteristics; minor non-linear dielectric effects in transformers, condensers and transmission lines; non-linear "B" vs. "H" magnetic core materials in transformers, chokes, microphones, speakers, etc.; non-linear magnetic flux distribution vs. vibratory member swing, in transducers such as speakers, mikes, phono pick-ups, etc. This type of distortion can be detected by the unaided ear as an unpleasant "sourness" or "harshness" and in combination with frequency discrimination, as "peaks", "lows" and "cut-off". It can be checked by running off rather laborious frequency-vs.-volts-output curves by means of a sine-wave oscillator and cathode-ray oscilloscope or harmonic analyzer of some sort or another.

### FREQUENCY DISCRIMINATION

Frequency discrimination distortion will also be found if a frequency response curve is run off for the whole operating range of the audio system, since the two types of distortion are closely related. Modern technicians now disregard the simple sine-wave method of rating audio equipment as being practically worthless and resort to other methods and standards for obtaining performance ratings of such equipment which must actually operate under dynamic complex-wave conditions (various square-wave and intermodulation methods). Simple sine-wave checks are useful now only as frequency discrimination distortion checks (general frequency range tests).

Frequency discrimination is a type of

distortion caused by the unequal amplification of various frequencies operating through an electrical network. It can be considered to be more or less a dual effect. In the case of complex waves, some frequency components are amplified to a greater degree than others and wave-form distortion takes place. In considering the useful operating range of the network, some frequency ranges will be amplified to a greater or lesser degree than others, and thus cause "peaks" and "lows" throughout the frequency range, and "cut-off" at the extreme ends of the operating range. This distortion can be detected by the ear and checked with equipment as explained in the case of harmonic distortion since the two are closely related.

This distortion effect tends to increase rapidly with the increase of amplification in any individual circuit or component since the greater the amplification the greater and steeper the cut-off effect at the higher frequencies. This is due to the fact that the stray shunt capacitances by-pass the higher frequencies while the lower frequencies continue to be amplified to a greater and greater degree and this results in an increasingly greater bend or knee in the response curve.

### PHASE-SHIFT DISTORTION

There seems to be more than one variety of this type of distortion which can be more readily analyzed and demonstrated mathematically than by means of any word pictures. Generally speaking, this distortion is caused by the alteration of the relative phase relationships of the various frequencies operating through an electrical network or else between the various frequency components of the various complex waves passing through the network. We might also say that it is the non-linear voltage vs. current wave phase-shift with the frequency being passed. We might also say that it is the wave-form distortion resulting from the different time delay of various frequencies and frequency components passing through electrical networks. Or we might say that it is the distortion due to the variation of the time constant of a system or component or transmission medium with the frequency being passed.

Magnetic core materials have lag effects known as hysteresis, and insulation has lag effects known as dielectric hysteresis. Transmission lines have "skin effect". All these total up to a "delay" distortion-effect upon the complex frequency being handled by an audio system.

This type of distortion is not ordinarily appreciable in the rather limited frequency ranges encountered in audio work and considerable phase-shift effects must take place before the average ear can detect the resultant distortion. An experienced ear can

*(Continued on following page)*





# MEISSNER INTERCOMMUNICATIONS KIT

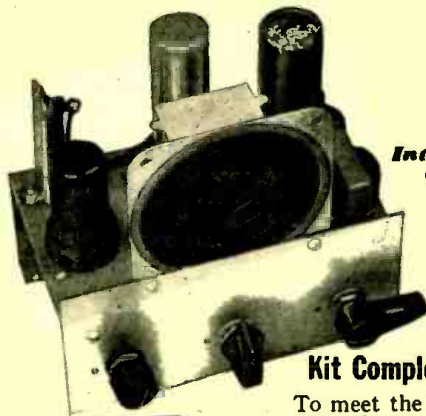

*Meissner  
Intercommunications Kit  
Chassis (Assembled)*

## Kit Complete, No Parts to Buy!

To meet the increasing demand for defense Classroom Training in Intercommunications, Meissner Engineers have designed an Intercommunications unit in Kit form. The Kit is complete, including all necessary parts, tubes and cabinet. Designed to cover a wide variety of requirements, the Master unit will communicate with 11 stations—regardless of type, Master or Substations mixed in any proportion and in any order. If all are Master Stations, the maximum number of stations possible on the system is 12.

Each Master Station is supplied with a special 13-wire 5' flexible cable complete with connectors. The Intercommunications Kit, when completed, occupies a minimum of space. The Station indicator plate on the Master unit is designed to permit frequent changes in markings without damaging the surface. Each Kit contains unusually complete instructions, including data on construction of a junction box.

Meissner Intercommunications Kit operates on 110-125 Volts AC-DC. Shipped complete with tubes (one each 70L7GT and 12SC7). Chassis 5 3/4" High. 6" Wide. 3 1/8" Deep.



*Model No. 10-1182  
Meissner Master Station  
Kits, including all parts,  
tubes, cabinet, etc. . . .  
School Net Price . \$18.90*



*Model No. 10-1183  
Meissner Substation Kit...  
includes cabinet speaker,  
switch, and all mounting  
hardware, etc. . . .  
School Net Price . . \$6.75*



**Meissner**  
MT. CARMEL, ILLINOIS

“PRECISION-BUILT PRODUCTS”

case of a radio receiver, even if the detector and audio amplifier circuits represent perfection ( $\pm 0$ -DB from 15 to 30,000 cycles), there would still be the transmitter's innumerable circuits to introduce about 2 1/2% harmonics. Even if the transmitter circuits were distortionless, we would still have the studio mike and the receiver's speaker and the acoustic conditions about them to consider. There will always be distortion effects present, which can be no more eliminated than can friction be totally eliminated from a machine.

In the case of audio amplifiers, the mere fact that a circuit has “no peaks” and has a “perfectly flat frequency response” tells us only a part of the story. At best, such response curves serve only as a rough basis for the comparison of similar audio circuits under similar conditions. In other words, it is perfectly possible for one amplifier circuit to have more harmonic distortion and a poorer “response curve” than another amplifier circuit and yet have superior all-round fidelity, and sound better, than the supposedly superior amplifier circuit. This may be true for the simple reason that the supposedly superior amplifier may have elaborate tone-control and inverse-feedback circuits which may compensate for simple harmonic distortion and flatten out “peaks” but which may cause some adverse effects when complex frequencies pass through the amplifier.

However, it must be admitted that exaggerated performance claims and trick compensating circuits are not necessarily bits of underhanded trickery or deliberate misstatements. The aforementioned devices and rating standards are outright necessities in commercial work, where gain, high output and high efficiency, all at low cost, are the major factors affecting design. Besides, if competitors rate the performance of their equipment by outmoded and inadequate standards, any one manufacturer would be exceedingly foolhardy to rate his by a more technical and exacting standard since his products would appear inferior in performance by contrast.

However, the “padded” response curves and performance claims sometimes put forward for audio equipment are so much tripe. Even if a response curve of an audio amplifier happens to be a fairly accurate gauge of its performance (so far as simple harmonic and frequency discrimination distortion is concerned), we often find, upon closer inspection of the frequency-response curve, the DB axis may be abnormally short as compared to the frequency axis, and the response curve is drawn in with a rather heavy line. That is, the DB axis may range from 0 to 10, 20 or even 40 DB in a relatively short span as compared to the long frequency axis. The response curve is actually no line at all but a belt a few DB wide within whose confines a thin-line hill-and-dale response curve may nestle quite comfortably.

If both DB and frequency axis are made of comparable length, a small DB range used, and a thin-line curve plotted, the result would be something quite different from the straight-line business with the two cute little cut-off ends.

### TRUE DB-RESPONSE CURVES

It should also be remembered that DB variations are logarithmic functions of frequency and the human ear responds likewise. To get a real response curve, we must use linear functions, such as Volts Output vs. Frequency, or Watts vs. Frequency, etc. With equal DB and frequency axis and a thin-line curve, such a response curve looks more like a seismograph recording than it does the “flat DB” type of curve usually encountered in audio work.

## PRACTICAL AUDIO AMPLIFIER THEORY

(Continued from page 291)

an electrical network do not have a linear time-vs.-frequency relationship with respect to the original signals. The actual existence of such a distortion effect might be checked by means of an “electronic switch” (thyatron); high-speed photography equipment; or a cathode-ray oscilloscope.

This effect can be noted by the unaided ear when a person abruptly barks into a microphone, or when any abrupt increase in the volume level occurs. It is due, no doubt, to reactive components and their delay effect in the various transmitter, transmission line and receiver circuits. It may simply be a transient form of phase-shift distortion.

Other types of distortion are due to the acoustics of the room or hall in which the loudspeaker operates. Reverberations, reflections, etc., have their effects on microphones, and on the human ear itself. This is important in motion-picture work, P.A. work, and in classrooms and in the home.

### AMPLIFIER RATINGS

In some non-technical literature presenting fidelity and power output ratings of audio circuits, the reader sometimes runs across such phrases as: “frequency response absolutely flat from so many cycles to so many cycles”; “distortionless output,” etc.

Let's analyze such statements and their implications.

In the first place, anyone speaking of an amplifier's output as being “distortionless” is simply talking through his hat. In the

**GIANT PHOTO-ELECTRIC CELLS**

Emby Products Co., Inc.  
Los Angeles, Calif.

THE new "Giant" R-1000 multi-cell type photoelectric cell has been added to this line of self-generating cells. The Unit is 7 $\frac{1}{2}$ " in diameter and has a current output of 4000-microamperes at 100-ft. candles. For use with twilight switches, light bar-

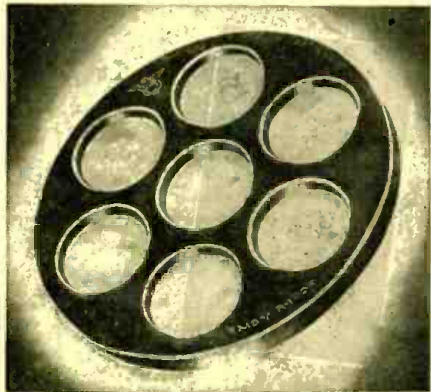

riers and other applications requiring a light-sensitive element at considerable distance from the control room, these cells are permanently stable and can withstand temperatures up to 70 deg. C. Spectral response extends from 240 milli-microns in the ultra-violet region, up to 720 millmicrons in the infra-red.

The cell has no fatigue or "drift" effect, and for most practical purposes has no measurable time lag. Response is instantaneous and light changes, of frequencies exceeding 10,000 cycles per second, can be recorded.—Radio-Craft

**HEAVY DUTY RHEOSTATS**

Clarostat Mfg. Co.  
285 No. 6th Street, Brooklyn, N. Y.

THIS extra-heavy-duty 50-watt power rheostat is an extension of the idea incorporated in the 25-watt rheostat, which was enlarged two years ago.

Selected resistance wire is wound on the insulated metal core which distributes the heat at intermediate rotational settings. The resistance element itself is firmly embedded in a ceramic housing with an inorganic cement, which results in a solid thermal

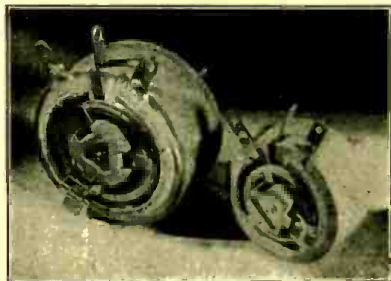

mass. The graphited-copper contact-shoe rides the collector ring and the winding, thus assuring two positive sliding contacts.

Contact pressure is provided by the helical spring, which is concentrically mounted about the shaft whose action is evenly distributed by the tripod-type contact-carrier.

The contact is insulated from the metal shaft by a center ceramic insulator, thus providing a "dead" shaft and mounting bushing.

These rheostats are available in any resistance value up to 10,000 ohms.—Radio-Craft

**ISOLATION TRANSFORMER**

Acme Electra & Mfg. Co.,  
Cuba, N. Y.

FOR the testing or communication equipment requiring unusual accuracy ordinarily done in a shielded test-room but which experiences interference through the power line, the Type T-4173 Isolating Transformer was developed. It makes use of a secondary completely enclosed in a copper shield. The secondary terminal connections are provided by means of a lead-shielded cable, the sheath of which is integral positively joined to the copper shield. Rated 2-KVA, it will handle a 50% overload. Regulation is 1% at 1-KVA.—Radio Craft.

**NEW OSCILLOSCOPE**

Radio City Products Co., Inc.  
New York, N. Y.

THIS new Model No. 555 Cathode Ray Oscilloscope was designed to meet requirements calling for extended frequency measurements.

A 5-inch tube is used, operating on 2000-volts. Maximum direct-current voltage at input terminals of the amplifier is 600-volts; direct to the deflection plates, 500-volts, RMS. Input resistance is 3-megohms, and frequency response is plus or minus 3db. from 20-cycles to 2-megacycles. Voltage gain is approximately 275. The ultra-wide



frequency range of the sweep signal generator is from 30-cycles to 350 kc, with linearity from 50-cycles.

Unknown peak input voltage can be read on a direct indicating multirange voltmeter. This is accomplished by a unique comparison method with an internal voltage source.

The instrument operates on standard 117-volt, 60 cycle current, and is housed in a 14" x 12" x 19" steel case, with carrying handle.—Radio-Craft

**Rheostats Pressed Steel**

Ward Leonard  
Mt. Vernon, N. Y.

WARD LEONARD Pressed Steel Rheostats with solid rectangular contacts provide a finer degree of control, smoother operation, and certain economies where interpolating rheostats would otherwise be required.

Rectangular contacts are available in small and large sizes. Small rectangular contacts can be furnished on thirteen inch or smaller rheostats. Large rectangular contacts can be furnished on eight inch or larger rheostats.

Rheostats with rectangular contacts can be furnished with complete enclosures, fittings for conduit connections, motor drives and with accessories for floor, back-of-board, and concentric mounting. Fixed and adjustable stops to protect control equipment can be provided.

These and other rheostats are listed in a new sixteen page Bulletin 60, available on request.—Radio-Craft.

**TECHNICAL BULLETINS**

Technical bulletins give reliable information in easy-to-follow form, and save valuable time otherwise spent in laborious reading of numerous books. Every subject is treated briefly and concisely, yet completely. No complicated mathematics, chemistry, electricity, or theory. Each bulletin is written in simple language.

PRICE \$1.00 EACH POSTPAID  
ORDER BY NUMBER

**ELECTRICAL DESIGN & CONSTRUCTION**

**D-111—DESIGNING AND BUILDING TRANSFORMERS.**—Simple, non-mathematical methods for designing transformers of all kinds. Also special transformers such as are used for ultra-violet lamps, Neon tubes, etc. No complicated formulas.

**D-112—DESIGNING ELECTRO-MAGNETS.**—The subject of electro-magnet design is so clearly explained that anyone can design and build magnets for practically every purpose. Complete, practical data covering both A.C. and D.C. magnets.

**D-113—HOW TO DESIGN SOLENOIDS AND PLUNGER MAGNETS.**—Anyone who is interested in solenoids or plunger magnets cannot afford to be without this non-mathematical, simple and practical information.

**D-101—USING NICHROME RESISTANCE WIRE.**—Explains how to repair electric flat irons, toasters, rheostats, resistors and other electric heating devices. Simplified methods of figuring lengths and sizes of wire for any job.

**D-106—REWINDING ELECTRIC MOTORS.**—Complete information, diagrams, sketches, tables, etc., to enable any shop man, mechanic, electrician, experimenter, etc., to rewind A.C. and D.C. motors and generators of all types. For the man who wants to know "how" rather than "why."

**D-144—A. C. CURRENT CONTROLLED WITH EASILY MADE CHOKER COILS.**—How to design and construct choke coils. How to determine size and amount of wire required, how to find the core size. Full details on assembly and coil winding.

**D-148—DESIGNING AND USING ELECTRIC RELAYS.**—Simple practical instructions for designing, building, and using A.C. and D.C. relays; also thermo-electric relays. Includes practical relay control systems for motors and machinery.

**D-127—SMALL ELECTRIC LIGHT PLANTS. DESIGN AND CONSTRUCTION.**—Tells how to design and build small electric light plants for cottages, camps or country homes at small cost. Covers construction of a 110-volt system to light six 30-watt lamps, how to build a 6-volt system using an auto-generator, with or without a battery, and how to convert a Ford model "T" generator to a 110-volt, A.C. generator.

**D-134—ELECTRICAL EXPERIMENTS WITH SIMPLE MATERIALS.**—How anyone without previous knowledge of electricity can perform harmless, interesting, and educational experiments with simple, inexpensive materials.

**D-131—MODEL MAKERS & INVENTORS GUIDE TO REMOTE-CONTROL SWITCHING.**—Controlling electrical devices, train models, equipment of all types at a distance by means of a telephone dial.

**D-137—ELECTRICAL METERS EASILY BUILT.**—Information that will enable students to build experimental electrical meters to measure alternating or direct currents. Including ammeters, voltmeters and wattmeters sufficiently accurate for experimental purposes.

**D-136—SMALL A.C. ARC WELDER CONSTRUCTION AND USE.**—Tells how to build arc welders capable of fusing iron and steel sheet up to 3/16 inch in thickness and rods as large as 1/2 inch in diameter for use on 110-volt, 60-cycle A.C., 110-volt 25-cycle A.C., or on 220-volt 60 cycle A.C.

Each Bulletin consists of a set of large sheets, assembled in one pocket, size 9 x 14 $\frac{1}{2}$ "; weight 1/4 lb. Numerous illustrations, diagrams, charts to supplement text.

**TECHNIFAX**

1917 S. STATE ST. RC243 CHICAGO, ILL.

1917 S. STATE ST. RC243 CHICAGO, ILL.

**TECHNIFAX** 1917 So. State, Chicago, Ill.

Enclosed find \$..... for which please send me postpaid the following Technical Bulletins:

Nos. ....

.....

Name .....

Street and Number .....

City and State .....

# BEGINNER'S DOLLAR RADIO

*For the fellow who likes to make things himself, "out of nothing," here is a challenge to his ingenuity. The items comprising this set are made of junk materials, and their making should be a cinch to those with patience and determination.*

**W**HAT is the simplest radio set that can be built, and also the cheapest? Considerable thought was given to this question and not a little experimentation produced this beginner's set, which should fill the bill.

It is, in fact, so simple, that with the exception of the radio tube, *everything* is made from junk and parts that can be found in any house. Yet, with all that, the set actually brings in distant stations from all over the country. There has been no idea to perfect anything on this particular set. It isn't intended to compete with the set that uses standard parts, to be sure. It is just a stunt to show what can be done with practically nothing and should be welcomed by youngsters from 8 to 80 who wish to accomplish the impossible with very little.

### HOW TO BEGIN

Let's take the set apart and build it up, one step at a time. Easy does it, so we begin on a sawed-off board measuring anywhere from 5x14 ins. to 8x20 ins. Finish it off as finely as you please, or leave it rough. It pays to take pains, though, and a well-sanded, shellacked base, set aside to dry, gets you off to a good start. Make a layout on a sheet of paper, full size—indicating just where each part is to go. This helps considerably when you wire the set.

The fixed condensers needn't scare you. They are of the "postage-stamp" variety, and are made from waxed paper and tinfoil.

Strip the foil from a pack of cigarettes or a tea package and smooth it out on a flat surface with your thumbnail. Cut six pieces, each 1x2½ ins. overall, with the

shape indicated in Fig. 2A. Cut eight pieces of waxed paper, 1½x2 ins. For the grid condenser, place a piece of paper on the set base in the front center, then a piece of tinfoil on top of that, with a 1-in. tab projecting from one end. Then another piece of paper, and the second tinfoil "plate" with the tab projecting 1 in. from the opposite side. That's the condenser! A piece of cigar-box wood a trifle larger than the paper is tacked by the corners (don't get the tacks near the foil) over the pile. Leave that for a while and build up the phone bypass condenser the same way, using two right- and two left-hand "plates" alternating.

Now we tackle the grid-leak, which is simply a high resistance path past the condenser. A piece of cigar-box wood 1½ ins. long by ½ in. wide is blackened on top with a soft pencil and then fastened lightly to the base with two brass-headed tacks or screws 1 in. apart. Don't tighten or drive down until connections are made—later.

### NOVEL TUBE SOCKET

The tube socket consists of 8 hole half-way through the base as indicated (Fig. 2B).

Contact is made to the tube prongs by means of 4 ordinary wire paper clips, bent so that the smaller part makes a spring contact with the prongs. Three of these clips are fastened to the base with washers and screws (or nails for that matter), but not driven all the way in. The fourth clip, bent as shown, is lightly secured by the washer and screw to be used as the "A—" terminal. And so we have the socket—and a real good one, too!

### TUNING CONDENSER

The variable condenser, if carefully made, will tune easily and well. Cut a piece of tin, copper, brass or aluminum 2½x4½ inches. Take time to smooth it out flat, with sharp edges filed or sanded off. Punch a hole in the center of one end. Shellac that portion of the base and one side of the plate. When the shellac is thick press down firmly in the place indicated. Slip a washer over a screw, twist the end of a 2 foot length of wire under the washer and screw tight. Cut another plate from the same material 2¾x4½ inches (not counting the half-inch square tab at one end). Smooth and flatten as before. Punch a hole in center of tab and screw a cork on, with the end of a piece of flexible wire (old lamp cord, or any wire not stiff) 12 inches long under the washer. Soak a piece of cellophane 3x5 inches in water for a few minutes; then place it on the lower plate, leaving an even margin around the edges. Press down tightly and shellac the edges to the wooden base. Guides are fastened to the base. They are simply strips of tin fastened with thumb tacks, and serve only to keep the movable plate on the right track.

A piece of cigar-box wood, ½x4 inches, is screwed with two screws in the position shown. Tightening or loosening the screws serves to produce just the right tension on the movable plate.

### WINDING THE COIL

Now we tackle the three-circuit tuning coil, and again it is easy if we take it one step at a time. Get a cardboard tube 2½ inches in diameter (baking powder, coffee, salt carton) and cut with a razor blade to 4 inches in height. Begin ¼-inch from one end and wind on 30 turns of No. 28 insulated wire (cotton, silk or enamel). Bring the ends down through pinholes in the tube. Put little tickets on each lead indicating which is which, so that when the coil is mounted you will have no difficulty with wrong connections.

Next leave a gap of ⅛-inch and wind on 60 more turns. Don't break the wire here, but leave a 3-16-inch gap and continue for 30 more turns. Bring the ends down inside the tube to the same end as the primary coil and mark for identification.

Punch holes in opposite sides of the tube in the center of the 3-16-inch gap to admit a piece of stiff wire used as a shaft for the "tickler" or feed-back coil. This coil is wound on a 2-inch tube ¼ inches high. (Cut a 1-inch piece out of a section of the 2½-inch tube, overlap ¼ inch and glue or tie in place, or use a 2-inch tube if available.) Wind 20 turns on each side of the center, leaving ⅛-inch gap for the stiff wire shaft. If flexible "cord" is handy, attach 1-foot pieces to each end of coil. Otherwise just leave ends that long.

Now straighten out a 5-inch piece of

Here's the way it looks when you get finished! The location and appearance of the parts is clearly shown, and some idea of the itemized costs is indicated. The tube shown is a 1G4-G.

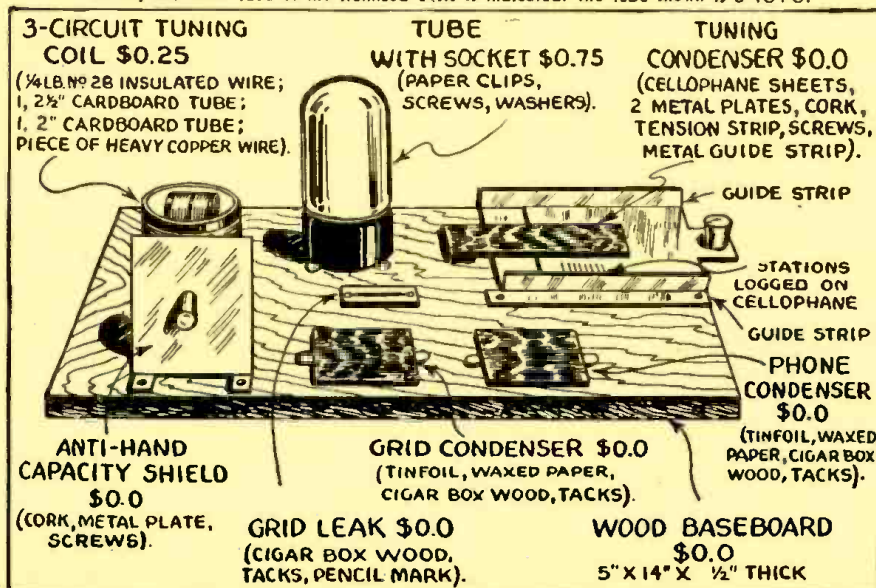

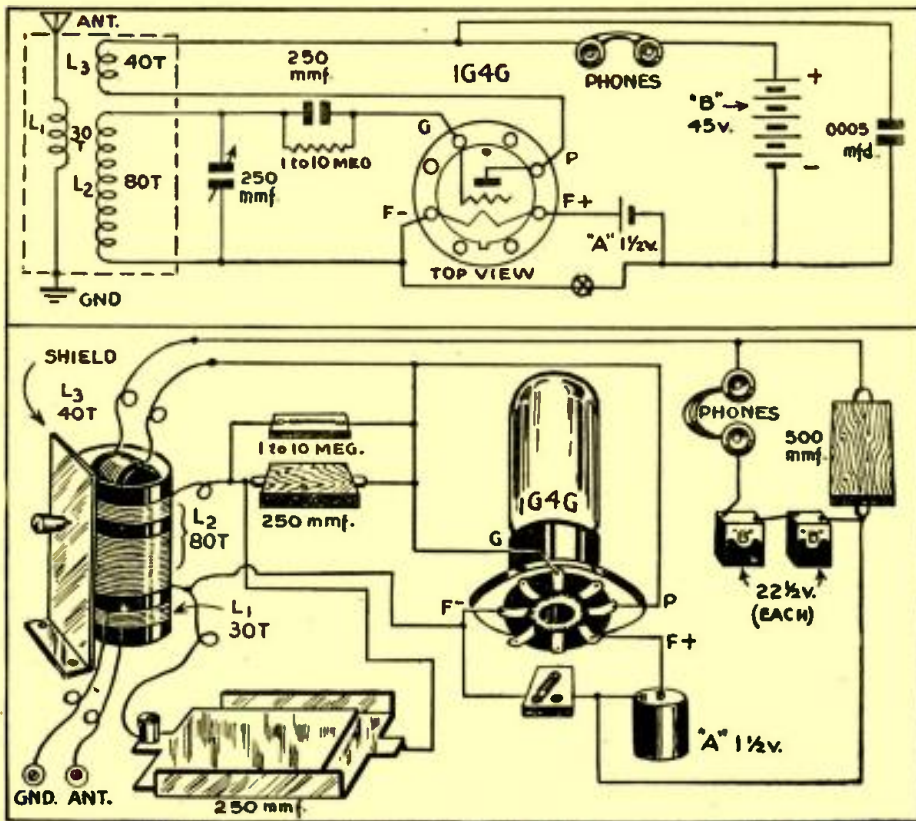

Fig. 1—Picture diagram and schematic circuit used in this set.

just plain wood screws with washers.) One lead from the tickler (L3) goes to one phone post and to one tab of the bypass condenser. The other end of L3 goes to the tube plate clip. Run a wire from the "B—" post to the other end of the bypass condenser and then to "A—" (which holds one socket clip). The grid clip of the tube socket goes to the grid condenser and grid-leak. The remaining end of the spool wire goes to the remaining clip, "A+", of the socket. The last wire connects post "B+" to the remaining phone post.

HOW TO OPERATE IT

Hook up the "A" cell, as shown, with the center terminal or positive, going to the F+ connection on the tube socket, and the outer, or can (negative) terminal going to the F—connection on tube socket.

Hook up the 22.5 or 45 volt "B" battery as shown, with the plus (+) terminal going to the earphones and the negative (—) terminal going to the outer (negative) terminal on the "A" cell.

Notice that a modern "low-drain" tube is used, the 1G4G. Its filament operates on 1.5 volt "A" cell without any resistors, and its plate operates very nicely on 22½ to 45 volts of "B" Battery. This tube has 7 prongs, but only four are used, and the socket in which it is mounted must be of the Octal or 8-prong type, hence the 8 holes.

Now all you have to do is turn the tickler slowly and move the condenser at the same time. There is a slight click when

stiff wire (a package handle wire is fine) and push it through the hole in the outside coil. Now a washer; punch through both sides of the tickler at the center gap, another washer, and the back side of the coil projecting ¼ inch. Sealing wax on the shaft and inner surface of the tickler will secure both very nicely. Shellac all coils (although not really essential).

Now mount the coil in any way you like, so long as it is upright, with the tickler near the top. Bring the 4 leads out at different parts of the bottom of the tube to eliminate any possibility of short circuits. The tickler leads come out at the top.

The shield in front of the coil is a square piece of any metal available, with bent-over feet at the bottom and a hole punched to pass the tickler shaft. At this point you can make the first complete connection. Bring the top end of the antenna coil (L1) to one foot of the shield, scrape off the in-

sulation and secure under foot, bringing the end back to post "G" (ground). The shield should be ¼ inch from the side of the coil. Drive a cork on the wire shaft, pushing it far enough to spring the shield toward the coil slightly. This provides friction, necessary to make the tickler stay where you turn it.

CONNECTING UP

Now for the wiring. If you have left the proper lengths as instructed it will be easy, and no solder need be used if you don't have it. Run the bottom lead of L1 to post "A" (aerial). The bottom lead of L2 (grid coil) goes to one tab of the grid condenser and one end of gridleak, along with one lead from the variable condenser.

Roll the foil around the wires and press them tightly together. The top of L2 goes to post "A+", where the other variable condenser lead joins it. (All "posts" are

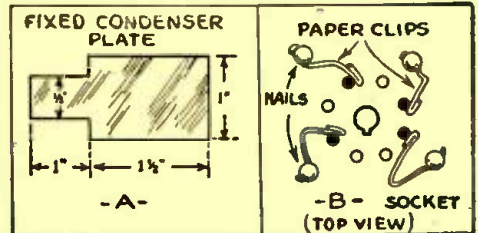

Fig. 2—Showing shape and dimensions of fixed condenser plates at A, unique socket at B.

the tickler coil goes into "oscillation." This is the most sensitive setting. There may be squeals or howls or bleeps, but rock back and forth till proper point is found. A little practice will enable you to tune easily.

Use a pencil eraser to erase part of the grid-leak, a little at a time, until the tickler works smoothly and programs are loudest. And there you are! Good luck!

A VICTORY CODE-PRACTICE OSCILLATOR

GOOD radio operators are urgently needed by our Armed Forces. Men who are interested in radio and who expect to get into the Service in the future should make preparation to meet the requirements of a radio operator of the Armed Forces by being able to send and receive the code at a speed of not less than ten to fifteen words per minute. The code can be quickly learned by two or more persons getting together regularly and practice sending to each other while the others copy. The only real requirement is a suitable code-practice oscillator.

The code-practice oscillator to be described can easily be made from parts found in any junk-box. The transformer (T) is a push-pull input transformer (in the case of the author, the primary winding was open) or it may be a push-pull speaker

transformer. The tube may be any type tube that a power supply to operate it is available. A 1A5G/GT tube works extremely well when used with a 1½ volt "A" battery and a 45 volt "B" battery. The condenser (C) is necessary to get the "feed-back" for the circuit to oscillate. Any capacity condenser of about .001 mfd. is suitable. Rheostat (R)

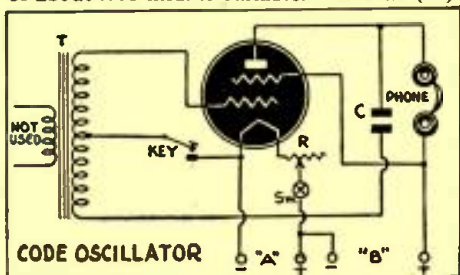

may be any available of about 30 ohms resistance and is used to drop the "A" battery voltage to the required tube filament voltage. The "on and off" switch (Sw) may be on the rheostat or it may be separately mounted. In most cases the 'phones may be substituted by a P.M. speaker with a suitable speaker transformer. The key is placed as it is in the circuit to eliminate "key-clicks."

This code-practice set may be assembled on a bread-board type arrangement or it may be assembled in a cigar-box with the "A" and "B" batteries being made up of flashlight batteries and inclosed in the cigar-box also. The author has built several of these sets and has yet to experience any difficulty in obtaining satisfactory results.

HARRY WOOD, JR.,  
Texarkana, Texas

# R.F. AMPLIFIERS

*Radio-frequency circuits, as used in new and old type receivers, are discussed here, in order to acquaint the beginner with their arrangement. It should prove helpful in analyzing circuits of various sorts, whether a set is being built or repaired*

**F**OR purposes of simplification we can classify the various functions of a receiver into the *radio frequency, detector, and audio frequency* stages. In this discussion we will confine our attention to the radio frequency stages. The other two will be taken up later.

One or more R.F. stages are incorporated into a radio for the purpose of building up the signal from the broadcast station, so that it will have sufficient amplitude (strength) to be detected properly with the minimum of *background noise* which accompanies the signal and becomes noticeable by the time it gets to the detector stage.

Or to put it another way, without R.F. amplification a lot of stations (the weaker ones, or those more distant) would not be heard.

## TYPES OF R.F. AMPLIFICATION

Roughly, R.F. amplification may be divided into two classes—tuned and untuned. Let's take up the untuned type first.

Fig. 1 shows a multiple stage *untuned*

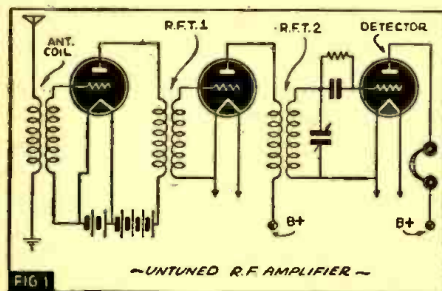

*radio frequency amplifier.* The very small alternating high-frequency wave received by the antenna causes a current (of the same frequency) to flow in the antenna circuit, comprising the antenna, itself, the antenna coil, and the ground. The current, flowing through the antenna coil (or the primary) creates a magnetic field which in

turn causes a potential of the same frequency to be induced across the secondary of the coil. Note, however, that this secondary is in the *grid* circuit of the first tube, and hence this potential (or voltage) is impressed on the grid.

Now in a vacuum tube, a small potential on the grid can control a comparatively large current in the plate circuit. This current flows through the primary of the radio frequency transformer (marked RFT-1). Once again, as in the antenna coil, we have magnetic action and consequently a voltage is induced across the secondary of the coil, and is impressed on the grid of the next tube. A sufficient number of R.F. stages can be used until the signal is of such strength that it can be detected.

It should be observed that the voltage amplification is sometimes secured only by means of the tubes. The purpose of the R.F. transformers is to obtain an alternating voltage across the secondary (or on the grid of the tube) caused by the varying plate current of the preceding tube.

We also secure a voltage step-up by having the secondary wound with more turns of wire than the primary. There is a tendency, in such an inductance, for the amplification to increase as the frequency increases. This would mean that the amplification would not be constant over a wide range. Such a coil arrangement would tend to make the circuit unstable, since there would be the possibility of *feedback* of energy from the plate circuit to the grid circuit, through the tube interelement capacity.

Where the primary and secondary of an R.F. transformer are of the same size, amplification, although somewhat lower, is fairly constant, over a wide range, and with less feedback. (By *feedback* we mean that condition whereby a tube begins to act as an oscillator or a generator of radio frequency energy. A tube, designed to act as an R.F. amplifier, and behaving as an oscillator, causes howling, squealing and loss of efficiency in reception.)

Untuned R.F. stages are seldom used these days, except in special-purpose circuits, and it is well to know about them in case you ever work on, or try to rebuild, an old-time receiver which used them.

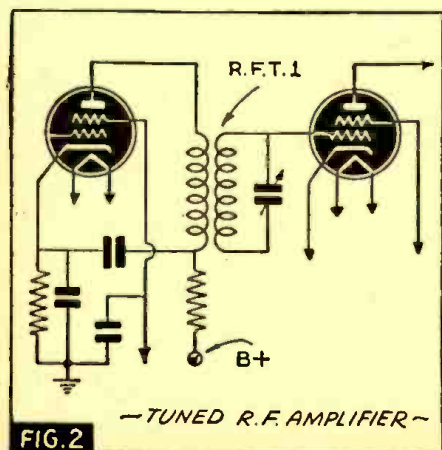

## TUNED R.F. AMPLIFIERS

When we deal with an R.F. amplifier, we must handle waves that vary from a few hundred thousand cycles per second to several million cycles. In order to secure greater efficiency and selectivity (ability to get each station clear, without interference), from our R.F. transformers, we place *variable condensers*, (or tuning condensers), across the secondaries of these coils, thus enabling us to tune in the particular frequency we want.

This type of circuit is known as a *tuned radio frequency amplifier* (See Fig. 2), and radio sets employing it are known as T.R.F. receivers.

The action of such an amplifier is the same as before. Plate current flowing through the primary of the transformer, by magnetic action causes an alternating voltage to be placed on the grid of the following tube. In this instance, however, the secondary is tuned to resonate at the frequency desired, by means of the variable condenser connected across it. Sometimes the primary is also tuned in this fashion.

It should be observed (in Figure 2), that use was made of *screen-grid* tubes, in this way avoiding *feedback* through tube capacities, a situation difficult to overcome with the triodes shown in Figure 1, except through the use of an external *neutralizing* device.

In receivers employing R.F. amplification, the T.R.F. (tuned radio frequency) amplifier has found the widest application, but it should not be thought that the circuits described so far are the only ones in use.

## TUNED IMPEDANCE R.F. COUPLING

In the *tuned impedance coupled* R.F. amplifier, shown in Figure 3, we obtain a *voltage-drop* across an impedance, and apply the changes in voltage across this impedance, to the grid of the next tube, through a fixed condenser. The coupling device consists of a coil and a condenser placed in parallel (or shunt), and inserted between the plate of the tube and the source of voltage; that is, in the plate circuit.

In rotating the variable condenser, the coil-condenser combination is tuned to resonance with the frequency to be received, and in so doing offers the greatest possible impedance to that frequency.

The plate current, meeting this maximum impedance, produces the highest possible voltage-drop across the coil-condenser combination. The voltage changes are applied to the grid of the following tube by means of the fixed condenser connected to the impedance. The size of the coil and the capacity of the variable condenser are so chosen that they tune over the desired bands of frequencies.

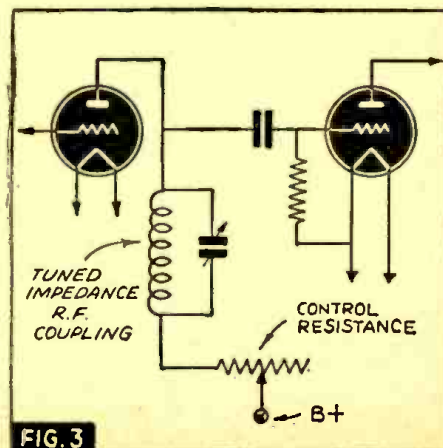

In a circuit of this type, difficulty is often experienced with feedback, since it cannot be controlled by neutralization. Resistors to control oscillation are generally placed in the positive voltage lead. Such R.F. amplifiers, as a rule, are seldom multiple-staged, due to oscillation tendencies.

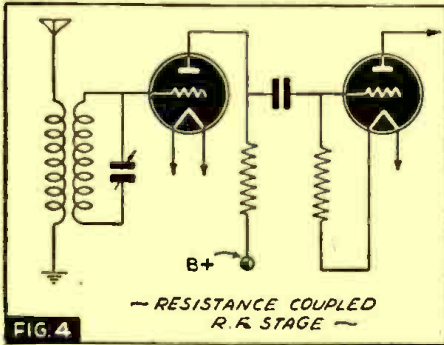

FIG. 4

— RESISTANCE COUPLED R.F. STAGE —

**RESISTANCE COUPLING**

Another type of amplifier, known as the *resistance coupled* R.F. amplifier, is shown in Figure 4. This circuit is seldom used for R.F. amplification. However, resistance

coupling widely used in audio frequency work will be described in a future article.

**BAND PASS FILTERS**

Sometimes certain undesirable effects, known as *cross-modulation*, and *second harmonic generation*, are present in receivers. In order to avoid this effect, a *band-pass filter* or *band-selector* is used, as shown in Figure 5.

The purpose of such a filter is simply to present a high impedance (or resistance) to all unwanted frequencies and at the same time allow the reception of those frequencies it is desired to receive. Since the *band-pass filter* couples the antenna to the grid of the first tube through a number of tuned circuits, a sufficiently high order of selectivity is obtained so that a strong signal, after passing through the filter, will not be strong enough to cause the R.F. tube to act as a detector.

imum results out of the more efficient and more sensitive tubes.

**SUMMARY**

The ideas presented here are chiefly to acquaint the beginner with the various types of R.F. circuits so that he will recognize

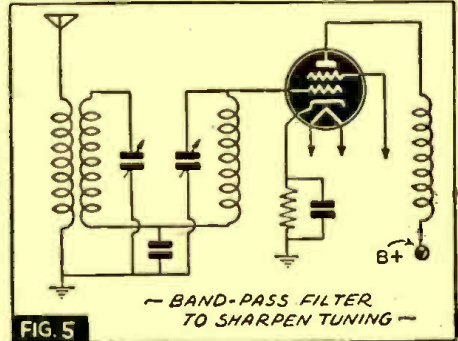

FIG. 5

— BAND-PASS FILTER TO SHARPEN TUNING —

**R.F. AND HIGH MU TUBES**

When the multi-grid or high-mu, (also known as variable-mu), tubes were developed, it became necessary to make all the coils involved in the R.F. section, of the high-impedance type, in order to get max-

them when he sees them on old sets he may try to rebuild or repair.

The design of modern superhets and all-wave R.F. sections is something that requires a little more knowledge and experience with, before being gone into, and will be covered in later articles.

# R.M.A. COLOR CODES FOR THE BEGINNER

IT ISN'T usually very long before a beginner, constructing some piece of radio equipment, even a simple one-tuber, runs up against the question of what size resistor or condenser he is using, or how to tell the leads of transformers, speakers, etc., one from the other.

To help him learn how to do it very easily, we present the R.M.A. (Radio Manufacturers' Association) color codes here-with.

**RESISTORS**

|        |   |        |   |
|--------|---|--------|---|
| Black  | 0 | Green  | 5 |
| Brown  | 1 | Blue   | 6 |
| Red    | 2 | Violet | 7 |
| Orange | 3 | Gray   | 8 |
| Yellow | 4 | White  | 9 |

These designations apply to body color, tip color and dot color.

For the body and tip colors you mentally carry the figures indicated, and then for the dot color convert the digit indicated, to a *number of zeros*, and add them to the first two figures.

For example, a red body resistor with a violet tip and a green dot, would be read: Red, 2; violet, 7; green, 5 (5 zeros); equals 2,700,000 ohms, or 2.7 megohms.

If a resistor has only a body color and a tip color, but no dot, it means that the dot is the same color as the body. For example a red body resistor with a green tip would be read: Red, 2; green, 5; red, 2 (two zeros); equals 2500, or 2500 ohms.

Sometimes, especially with the better quality type, the resistors are banded, that is, the colors occur in bands, with additional bands in gold or silver, or blank. These are read from left to right the same as before, but in addition the gold band tells us that it is within 5% of its rated value, the silver, 10% and the blank band, 20% or more. These gold and silver bands are called the "tolerance" bands and tell you how accurate the resistor is. This is very important when you are using sizes called for by the manufacturer or the designer.

A lot of ineffective apparatus is produced by some setbuilders and repairmen because they use any old size, thinking it won't make any difference.

We might inject here that we realize a man can't go around to a job or to an examination with a color card in his hand, so most men memorize it. It is very easy. Just say to yourself: "Black and brown are zero and one. Gray and white are 8 and 9. The other colors from red to violet are the colors of the rainbow—red, orange, yellow, green, blue and violet—2, 3, 4, 5, 6 and 7."

**CONDENSERS**

Condensers are marked the same way as resistors so far as a table of figures and zero equivalents is concerned.

You look at the condenser on the side that is trademarked. The three dots are read from *left to right*. The final number obtained is in *micromicrofarads*. If you want to convert to microfarads, just simply divide the figure obtained, by 1,000,000, that is, move the decimal point six places to the left.

Sometimes arrows or arrowheads occur. Just simply read the dots above or in these, from tail to head. They indicate that you should read from left to right.

Regarding tubular paper condensers, some manufacturers, in addition to the colors discussed above, use the following colors to indicate the D.C. working voltage:

|        |           |        |      |
|--------|-----------|--------|------|
| Brown  | 100 volts | Violet | 700  |
| Red    | 200       | Gray   | 800  |
| Orange | 300       | White  | 900  |
| Yellow | 400       | Gold   | 1000 |
| Green  | 500       | Copper | 1600 |
| Blue   | 600       | Silver | 2000 |

**I. F. TRANSFORMERS**

|       |                   |
|-------|-------------------|
| Red   | "B"-plus lead     |
| Blue  | Plate lead        |
| Green | Control-grid lead |
| Black | Grid-return lead  |

(If the secondary is center-tapped, the

second diode plate lead is green-and-black striped; and black is used for the center-tap lead.)

**AUDIO TRANSFORMERS**

|         |  |
|---------|--|
| Red     | "B"-plus lead  |
| Blue    | Plate lead   |
| Green   | Grid lead  |
| Black   | Grid return  |
| Brown,  | Start lead of plate winding in C. T. transformers            |
| Yellow, | Start lead of grid winding if secondary is tapped.           |
| Brown,  | Start lead of plate winding if transformer is center-tapped. |
| Yellow, | Start lead of grid winding if transformer is center-tapped.  |

Note: If polarity is not important, the brown and yellow leads may be blue and green respectively, in some transformers.

**LOUDSPEAKER VOICE COILS**

|             |             |
|-------------|-------------|
| Green Black | Start lead  |
| Green       | Finish lead |

**LOUDSPEAKER FIELD COILS**

|                |             |
|----------------|-------------|
| Black and red  | Start lead  |
| Yellow and red | Finish lead |
| Slate and red  | Tap lead    |

**POWER TRANSFORMERS**

|  |                   |
|--|-------------------|
| Primary  | Both leads, black |
| (If primary is tapped, black is the start or common lead; black and red striped is the finished lead, and black and yellow is the tap lead.) |                   |
| Rectifier Plate Winding  | Both red          |
| Center tap is red and yellow striped   |                   |
| Rectifier Fil. Wdg.  | Both yellow       |
| Center tap is yellow and blue striped  |                   |
| Fil. Wdg. No. 1  | Both green        |
| Center tap is green and yellow striped   |                   |
| Fil. Wdg. No. 2  | Both brown        |
| Center tap is brown and yellow striped   |                   |
| Fil. Wdg. No. 3  | Both slate        |
| Center tap is slate and yellow striped   |                   |

# THE BEGINNER'S "PLASTICETTE" RECEIVER

By HOMER L. DAVIDSON

**T**HIS compact little receiver will be of interest not only to the beginner, but also to the experienced builder and experimenter as well. In fact, many of the boys in the service have written in to *Radio-Craft* asking for a description of a receiver of this type.

It is battery-operated and might be objected to on these grounds, but bear in mind the fact that the chassis can be used for other experiments, and also can be used after the war when batteries are available again. For those who have, or can get batteries, this description will be useful.

## GENERAL DESCRIPTION

Basically it is the solid combination of proven worth, a triode in a regenerative circuit. The triode used is the high-mu, 1.4-volt 1H5GT tube. And the regeneration used is the Armstrong or tickler coil type.

A 25,000-ohm volume control is used for controlling the amount of regeneration, and it is of the tiny or midget type, in order to fit into the set-up.

It is wired directly to the plate of the 1H5GT, with its center tap connection sol-

*Here's a sweet little job in midget receivers, with the additional interesting feature of being housed in a plastic case which can be made by the constructor*

inch thick. The tube was mounted at an angle in order to give room to the other parts.

## OPERATION

After the chassis has been completely wired up, and ready for operation, the batteries are connected to the correct terminals as described. Check and double-check, so you won't burn out a tube.

It was found best to mark a A-plus, A-minus, B-minus, and B-plus on small strips of adhesive tape, and wrapping them around the three correct wires.

When operating this receiver, it will be found it does not tune-in like the usual broadcast receiver, but tunes very sharply and whistles on every station.

First turn on the switch to the batteries and see if the tube shows any light. It is very difficult to see the filament lit up, so to check further, just place the finger on the control-grid cap of the tube, and a hum should be heard. Then place the antenna to the set, repeating the process, and a louder hum should be heard. The receiver is then ready to operate.

Slowly turn the tuning dial over its range and note the many station whistles, with the regeneration control turned up. If this does not occur, check over the tickler winding and reverse the connection, and try again, until oscillation begins. When a sharp signal is heard, rotate the tuning dial until the signal is as loud as possible. Then lower the regeneration control until the signal turns into a "popping" sound, when the station can be heard.

The constructor will be surprised to find that many stations, hundreds of miles away, can be heard at night, with an antenna 80 to 100 feet long, mounted as high as possible. The antenna trimmer condenser, by the way, is not very critical, and can be around 25 to 30 micromicrofarads.

## PLASTIC CABINET CONSTRUCTION

The builder can now make his own plastic cabinet, out of old phonograph records. Start off with two of the 10-inch size and break them in two at the middle. This can be done if a sharp line is drawn on the record, and the record then broken over a sharp edge, such as a table or desk.

Then lay out the pattern of the side—and cut out as many as possible from each record, using a knife and a straight edge.

The top and bottom pieces are 3 by 3 inches. The bottom piece has two 1/8-inch holes drilled 2 inches apart, with two small wood screws fitted into the wood chassis. The two side pieces are 3 inches square, with one side having a 3/8-inch hole about 1 inch from the back of the receiver.

The front is also 3 inches square, with a 1/2-inch hole drilled into the middle of the panel. If you have a pair of tinsnips, you can start with a piece of record that will give a 3-inch square, approximately with an additional 1-inch clearance. Hold the material well above the flame and in a few seconds it will become limp. It can then be easily cut with the tinsnips.

## MOLDING THE PANEL

The process of record plastic molding is simple and any person with a gas range or

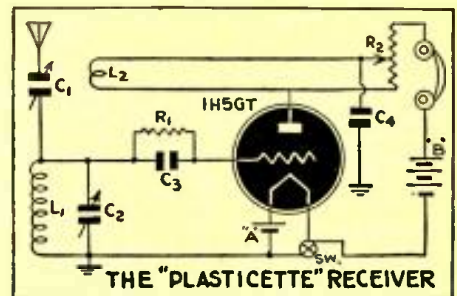

a hot flame can do a neat job. For a pattern mold, the author used a small 3-inch square ash tray with a fancy edge. It was about 1/2-inch deep.

To mold the front panel place the heated record over the ash tray, pressing down with the fingers or with a pencil. If the first time the record becomes brittle and hardens before the panel is formed, repeat the process.

After the mold is completed, square all the sides measuring 3-inches, heat again and cut off the excess material. To give a smooth slick finish, iron out all sides with a cold iron.

## FITTING TOGETHER

Next file the rough edges and fit all sides together. To melt the sides together, heat a file until the end is red hot and apply to the insides of adjoining pieces. Then cut a few 1/4-inch strips of record and lay in the file furrow, and mold the sides together. (The molder will find that the pieces will become very crisp and brittle, and cannot be dropped at this time.)

When all the sides are fitted together the cracks can easily be filled with small pieces of record. Then bevel all corners with the hot file and follow up with the fine rasp file.

A striking finish can be acquired by applying a coat of aluminum paint, then a coat of white enamel.

An attractive dial was drawn with India ink, with a ruling pen and a protractor,

The knob was taken from the cap of a fingernail polish bottle. A 1/4-inch hole was

(Continued on page 301)



The compact size of the receiver, and the hand-made appearance of the home-made plastic case, is shown herewith.

dered to one side of the tickler winding. Its other terminal goes to the earphones. (The earphones, by the way, can be a pair of 2000-ohm type. It was found they gave good audibility.)

The grid and tickler coils can be wound by the constructor if he desires, but the grid coil used in this receiver was the secondary winding from an antenna coil, such as are used in small A.C.-D.C. broadcast receivers. The tickler winding consists of 35 turns of No. 28 enameled wire wrapped around the middle of the grid coil. If one wishes to wind both coils, a coil form 1-inch in diameter by 2 1/2 inches long will be sufficient, with 125 turns of No. 28 enameled wire, to tune with a .000365 mfd. tuning condenser of the midget type.

The grid coil is wound first. Then place two layers of wax-paper over the grid coil, lapping one side of the paper so as to hold the starting winding. Both these windings are wound in the same direction, and to hold the primary winding tightly to the grid coil, a layer of "coil dope" may be applied, looping both ends of the coil form. It may be found necessary to juggle with the tickler winding, removing or adding a few turns to get the correct amount of oscillation. The wood chassis used, was 2 1/2 x 3 inches x 1/4-



# AUTOMATIC VOLUME CONTROL IN BROADCAST RECEIVERS

By S. J. NASTE

**V**ERY little, if anything has been written concerning the operation of automatic volume control in broadcast receivers. Most modern beginners have heard of, and have seen the term "A.V.C." and I am sure they will welcome a clear treatment of the subject.

The purpose of A.V.C. in any receiver is to keep the output of the detector tube at a constant level over wide variations of signal input to the antenna. In order to keep the output of the detector at a constant level the gain of the tubes preceding it must

nearly constant level. It is impossible to realize 100% efficiency of the circuit, due to the time lag factor of the A.V.C. circuit, which varies with the different voltages produced across the A.V.C. load resistor, (R6 in Fig. 1), by the different field strengths of the various broadcast stations. This produces slight voltage differences in the output of the detector, which are so small as to be negligible.

To show how A.V.C. operates we will assume that a signal of given strength is applied to diode "D" of the detector in Fig. 1. Due to the rectifying action of the diode, a pulsating D.C. current appears across the diode load, R6. This voltage is negative in sign because it is in the secondary return circuit of the last I.F. transformer and all points between the secondary return circuit and ground (B-), are negative with respect to ground, ground always being at zero potential.

the circuit. This is shown by the following formula.

$$T=RC$$

T=time in seconds

R=total resistance of A.V.C. circuit in megohms

C=total capacitance of A.V.C. circuit in microfarads

Too small a capacitance will be manifested by hardly any A.V.C. action at all because of insufficient voltage developed across the filter unit. A time constant of 1/10 to 1/7 of a second is used for all practical purposes.

Condenser C7 is commonly called a "tank" condenser. When a strong signal is received it charges up to a certain level and

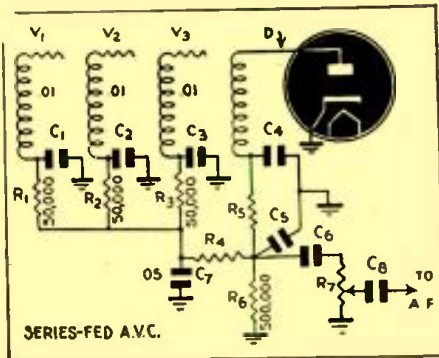

Fig. 1

be controlled so that they feed a constant voltage into the detector.

To accomplish this it can be seen that the gain of the tubes to be controlled must vary in inverse proportion to the received signal. For instance; the gain of the tubes, V1, V2, and V3 shown in Fig. 1, will be much lower for a strong signal than for a weak signal.

## HOW A.V.C. OPERATES

To the more technically minded, a high bias is applied to the tubes when a strong signal is received and their gain is appreciably reduced. This high negative bias on the grids of the tubes reduces their plate current, thereby increasing their plate resistance, and causing a consequent decrease of mutual conductance, thus reducing the gain of the tubes.

Conversely, when a weak signal is received less negative bias is applied to the tubes and they operate at higher gain thereby keeping the output of the detector at a

## CONTROL VOLTAGE

The control voltage for the tubes is taken from the junction of R5, R6 but since that is pulsating D.C., it must pass through the filter R4, C7, which smooths out the pulsations. When a strong signal is received a high negative voltage appears across resistor R6. When a weak signal is received a proportionately smaller voltage appears across resistor R6.

Getting back to the filter unit R4, C7, the operation is as follows: You will notice that the resistance, R4, is very high in value, and since it is in series with the grid circuits and the grids don't draw current, there is no voltage drop produced across it and the voltage across R6 appears on the grids of the tubes regardless of the size of R4.

## TIME CONSTANT

The size of R4, however, determines the time constant of the A.V.C. circuit. Too large a resistance would cause the A.V.C. circuit to operate too slow. This would be manifested by the signal coming in with a blast when a station is tuned in and a few seconds later the signal reducing in volume as the A.V.C. takes hold. The resistance was so high that it didn't allow the condenser, C7, to charge quick enough to apply the proper bias to the tubes. It must be remembered that the resistance and capacitance both control the time constant of

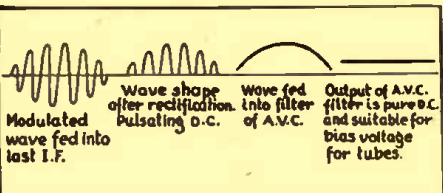

Diagram of automatic volume control circuit as used in many types of receivers. This particular type is usually designated the series-fed type.

applies this voltage to V1, V2, V3, as shown in Fig. 1.

When a weak signal is received the charge across the condenser decreases and a corresponding smaller voltage is applied to the tubes.

If condenser C7 opens, the pulsating D.C. will be superimposed on the grids of V1, V2, V3, and will modulate them at an audio rate. This will appear in the output as distortion.

Resistors R1, R2, R3, and condensers C1, C2, C3, act as decouplers to keep the signal of their respective stages from getting mixed up in the other stages causing oscillation or degeneration. They also serve as additional filters to further smooth the D.C. bias voltage applied to the tubes. The condensers in these decouplers should have the lowest amount of reactance possible at the lowest frequency to be received. Since these condensers are in series with the tuning condensers, the extra resistance that they add to the tuned circuit will have a tendency to make it tune broadly.

The filter R5, C4, C5, is an I.F. filter and serves to keep the intermediate frequencies from entering the audio circuit.

## ELECTRONIC PHONO PICKUP

(Continued from page 271)

this pickup, and the results were found to be highly satisfactory. The constructor of course may experiment with different cells and input circuits until he finds the best arrangement to suit him.

### Parts List

1—6-volt pilot lamp

### RESISTORS

1—1 Megohm, 1/2 watt  
1—50,000 ohm potentiometer

### CONDENSERS

1—1 or 2 mfd. paper  
1—.01 mfd., Paper

### MISCELLANEOUS

1—Lucite rod, 1/2 x 1/2 x 8 inches  
1—Discarded crystal pickup unit  
1—Photo-tube (caesium-gas preferred)  
1—Metal shield can.

## CAPACITANCE BECOMES BOSS

(Continued from page 269)

production but the extensive amount of research necessary for perfecting the meter and modifying it for its various applications. The cost of the parts in the meter

is a small fraction of the market price. Its circuit is actually very simple. Two oscillator tubes, one mixer tube, and one amplifier are all of the vacuum tubes required for a simple installation. The construction is so simple that even someone unfamiliar with radio could construct it. In spite of the great cost of the meter, it is being widely used in industry today, for the service that it performs far outweighs its cost. Indeed, if the apparently great demand continues to increase, it is almost certain that the cost will drop to a fraction of its present price.—Tech Engineering News, M. I. T.

# QUESTION BOX

By FRED SHUNAMAN, Technical Editor

## QUERIES

All queries should be accompanied by a fee of 25c to cover research involved. If a schematic or diagram is wanted please send 50c. to cover circuits up to 5 tubes; for 5 to 8 tube circuits, 75c; over 8 tubes, \$1.00.

No picture diagrams can be supplied.

Back issues 1942, 25c each; 1941, 30c each; 1940, 35c each.

Any issue, prior to 1940, if in stock, 50c per copy.

## GUITAR AMPLIFIER

? Please print a hookup for an excellent guitar amplifier.—H. F. L., St. Marks, Fla.

A. Herewith the schematic. For extreme-

ly low hum the amplifier may be used with a 53 and two 2A5's. 6L6's may also be used if more power is wanted, by using a lower value cathode resistor.

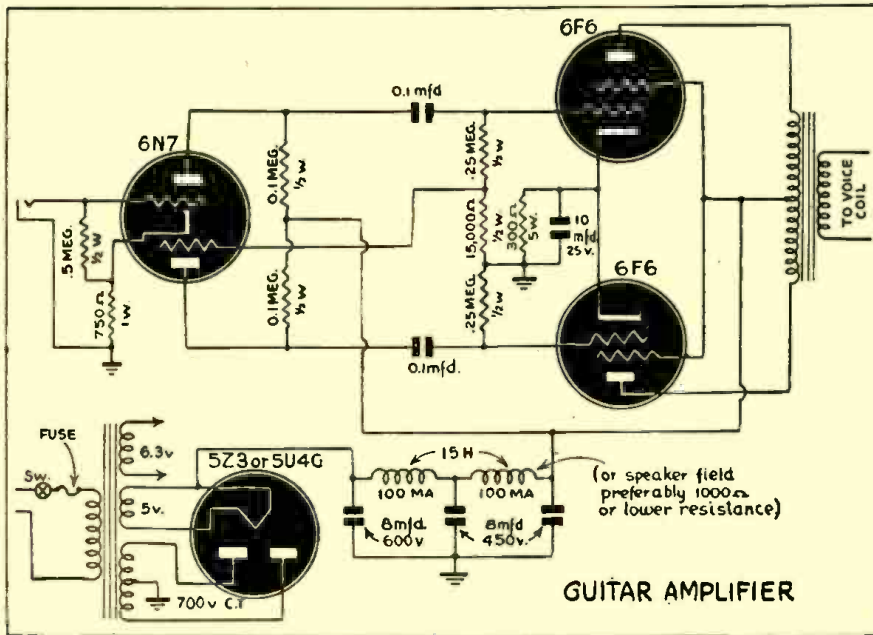

## POWER PACK

? Will you please give me a circuit of a power pack to operate automobile radios off either A.C. or D.C.—A. S., Bronx, N. Y.

A. The diagram requested is shown here. TRANS can be a big old-time broadcast transformer with taps on the primary for different voltages. Strip off all the windings but the primary, then wind a secondary of as heavy wire as you feel like handling, but at least No. 14. The bigger the better.

The secondary output should be about 15 volts, no load, when the primary tap is on the middle position.

CHOKE may be another big broadcast transformer primary. It doesn't matter whether or not the secondary and filament windings are taken off it, but take out the laminations and put them back choke fashion—all in one direction with a piece of thin fibre between the "E" and butt pieces.

COND is a 1,000 (one thousand) microfarad capacitor, built for use with 6-volt dry-plate rectifiers. If you can't get one now, use a few hundred mfd. of low-voltage radio condensers.

REC may be one of the old dry-plate (copper-oxide) rectifiers used for charging storage batteries. Those off old loud-speakers are usually not big enough.

To reduce D.C. to the proper voltage, build up a bank of lamps as shown. Use 100-watters for all but the biggest car radios.

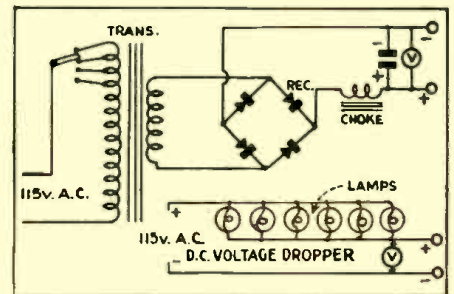

Hook the set across the output terminals, and screw in one lamp at a time till the voltage is correct.

A D.C. voltmeter must be used with these devices to assure proper voltages on the receivers.

## "A" AND "B" BATTERY TESTER

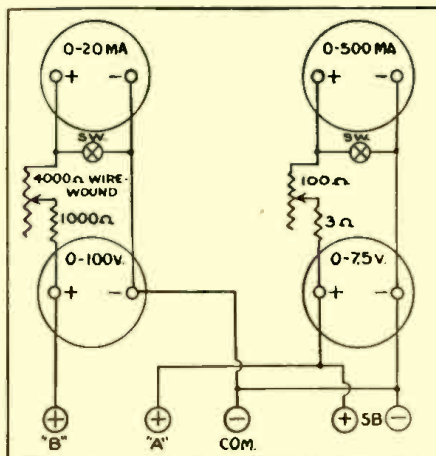

? Please supply me with the circuit of an "A" and "B" battery tester which can test radio batteries under load.—E. S., Palmerston, Ont.

A. Herewith is the circuit requested. The two switches marked SW should be of the instantaneous type, and should keep the circuit closed except when thrown and held over. This will protect the meter. The small fixed resistors in series with the variables are for the same purpose, though the wide range in battery voltages makes complete protection impossible. An improvement could be made in the "B" circuit by using a 2,000-ohm fixed resistor and a 3,000-ohm variable. The only disadvantage of this change is that the amount of current drawn from 22½ batteries would be limited, but this is not particularly important if you have very few 22½ units to check.

## A SIMPLE "B" ELIMINATOR

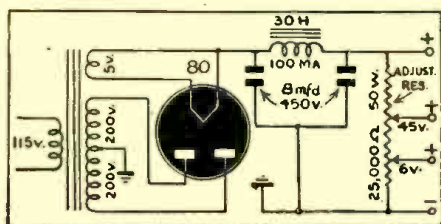

? Due to the shortage of batteries I would like to see you publish the plans for one or two simple "B" eliminators with a tap for 45 volts and 6 volts, using junk box parts.—E. K., Miami, Fla.

A. Herewith the schematic. Plans for "A" and "B" battery eliminators for portables may be found in the January issue.

## CHARGING BOOSTER

? This diagram is copied from a Radio-Craft of June, 1936. This uses two units instead of one, as shown in the original. Do you think it is advisable to use the two units?—J. F. S., Belleville, N. J.

A. The idea of using one unit for the radio and one for the heater is an excellent one, as there are many times when the one is on without the other.

The third brush is set for the full charge

required when the device is on, resistor D, (which may be a 20-ohm rheostat) being shorted. Then D is adjusted till the am-

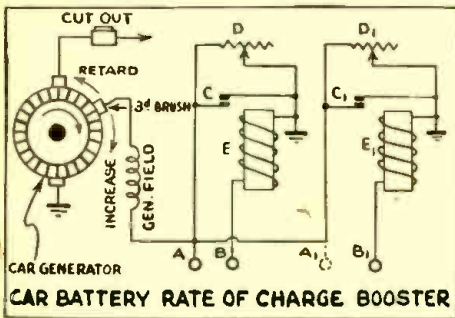

meter on the dash drops back to normal charge.

B is attached to any point on the heater or radio which is 6 volts from the car frame. CE can be a car cutout, the shunt winding, which uses only a few milliamperes, being used.

### A REAL PHONE OSCILLATOR

(Continued from page 286)

resulting from the power supply refinements.

#### Parts List

#### RESISTORS

- R<sub>1</sub> R<sub>2</sub>—3000 ohms, 1 watt
- R<sub>3</sub>—260 ohms line cord resistor
- R<sub>4</sub>—100,000 ohms, ¼ watt
- R<sub>5</sub>—100,000 volume control
- R<sub>6</sub>—600,000 volume control

#### CONDENSERS

- C<sub>1</sub>, C<sub>2</sub>—20 mfd., 150 volt midget tubulars
- C<sub>3</sub>—75 to 350 mmfd. trimmer
- C<sub>4</sub>—0.0001 mfd. mica condenser
- C<sub>5</sub>—5 mfd. 150 volt tubular

#### MISCELLANEOUS

- L<sub>1</sub>—See text
- T<sub>1</sub>—See text
- CH—7 henry, 200 ohm d.c. midget choke, Utah #4660 recommended
- 1—25Z6GT tube
- 1—6K7GT tube
- 2—8 prong octal sockets
- 4—Pin tip jacks
- 2—1" dia. knobs for ¼" shaft (optional)
- 1—Chassis, of #16 ga. steel

### THE BEGINNER'S "PLASTICETTE" RECEIVER

(Continued from page 298)

drilled about three-fourths of an inch through the middle of the cap and tapped with a 3/16-inch tap.

The wood chassis is 2½ x 3 inches and ¼-inch thick. The mounting of the parts is shown in the drawing. The mounting of the tube is in an angular position to provide room for other parts.

#### Parts List

#### CONDENSERS

- C1—Antenna trimmer, 0-35 mfd.
- C2—.000365 midget variable
- C3—.00025 mfd., mica
- C4—.005 mfd., mica

#### RESISTORS

- R1—3 meg.
- R2—25,000 volume control "baby" type

#### MISCELLANEOUS

- B—45-V. "B" Battery
- A—1½-V. penlite cell
- 1—toggle switch
- 1—1H5GT RCA tube

### CORRECTION

In the diagram of the Victory Receiver, page 165 of the December, 1942 issue, the following corrections should be made:

1. Insert a lead from the "hot" side of the 117-volt A.C. line, to the plates of the 25Z5.

2. Insert a lead from the B-plus to the R3-62,000 Ohm resistor, and to the tickler and screen of the 6F7.

3. Condenser C9 should be 10-mfd., 25-volt.

## NATIONAL UNION IS READY TO GREET ELECTRONIC SERVICE MEN

Every ounce of National Union energy is thrown into the battle for victory. Our engineering, our production, our manpower and machinery are in the fight. As we battle on the research and production front we see the dawn of great new horizons as new products, new and better methods develop; we see the Radio Service man to whom we have devoted ourselves through the years standing on the threshold of a greater opportunity than he has ever known. National Union is deeply grateful for the loyalty of the service profession to National Union products. National Union is learning, watching every advancement in the electronic art, so when the day of Victory comes, the many thousands of service men who have grown with us in the past shall benefit in the future.

### PHONO OSCILLATOR

The phonograph oscillator has become quite popular within the last year or so and the number of different types and designs of phono oscillators is almost as great as the number of new receiving tubes being introduced monthly.

The oscillator described here is unique in the fact that it requires only one battery to operate it. Advantage is taken of the high output and low current drain of the new 1.4 volt battery tube, the 1N5G/GT. The coil is of the "self-rolled" variety, saving the builder the expense of a factory-built coil. Bear in mind that the grid leak is a low value (10,000 ohms). If a receiving type grid leak is used, the tube will probably block and no oscillations will result. Blocking results when too high a leak is used; intermediate values of resistance will produce intermittent blocking which evidences itself by the fact that the oscillator will emit a tone-modulated signal which is useful in code practice, etc. Experiment with the grid leak until you get the desired tone. Use resistors from 50,000 to 1,000,000 ohms.

The input binding post is bypassed so that long leads to the "modulator" can be used without detuning effects. If a magnetic pickup is used, connect the leads directly to the input terminals. If a crystal pickup is used, connect about a 100,000 ohm resistor across the input terminals and connect the crystal pickup leads across this resistor, using a .02 mfd. blocking condenser in series with the pickup leads.

If you wish to talk over your oscillator, connect the leads from a pair of headphones to the input terminals.

(An old Baldwin headphone unit is ideal.)

To use the oscillator for code practice, use the high-resistance grid-leak as ex-

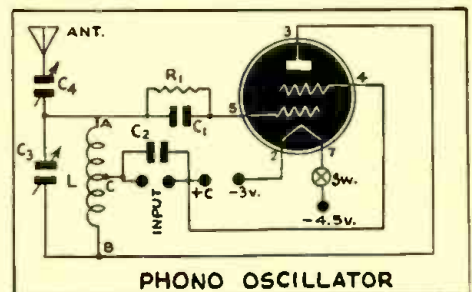

plained above and connect the key across the input terminals.

Note that if C4 is not available, two insulated wires twisted together a few inches will work as well.

If very high output is desired, C4 can be shorted out, but detuning effects will be very prominent. J. S. JACKSON, Bowling Green, Ky.

#### Parts List

#### CONDENSERS

- C1—250 mmf. (.00025 mfd.) mica
- C2—same as C1
- C3—350 mmf. (.00035) variable (old broadcast condenser will work)
- C4—small trimmer (about 50 or 100 mmf. maximum)

#### RESISTORS

- R1—10,000 ohm

#### MISCELLANEOUS

- V1—1N5G or GT
- L—see data given
- Antenna—few feet of wire
- Voltage supply is single 4½-volt "C" battery

Diagrams for

# THE RADIO EXPERIMENTER

If you have a new Hook-Up, send it along; a pencil diagram will do. Be sure to include a brief description.

All diagrams and descriptions accepted and published will be awarded a year's subscription. Diagrams may be for receivers, adapters, amplifiers, etc. Send them to Hook-Up Editor, RADIO-CRAFT, 25 W. Broadway, New York City.

## AMPLIFIER CIRCUIT

Finding myself in need of a fairly simple amplifier that would be used mainly with a record player, I decided to operate two permanent-magnet loudspeakers. I had quite a number of used parts lying around and decided to use the parts I had available.

A volume control was not used as there was one incorporated in the phono unit. However, if desired, a control may be installed across the primary of the input transformer. A tone control is also easily connected.

I might add that with 380 to 400 volts on the 6L6Gs, this unit makes an ideal modulator for a 40 to 50 watt input transmitter. With 330 volts on the 6L6Gs, the plate ma. were only 75.

All wiring was made as short as possible and well shielded to eliminate hum pick up. If only one loudspeaker is used it is a simple matter to remove one of the 76s and one 6L6G and the results are just as good as when all the tubes are in.

In the power supply two chokes of unknown inductance were tried out and found suitable.

The filter condensers were Aerovox PK450.

As 2.5 volts were available as well as 6.3 volts, I decided to use two 56s or 27s as drivers for the 6L6Gs.

### Parts List

#### CONDENSERS

- C1—10 mfd.
- C2—1 mfd.
- C3—8 mfd.
- C4—8 mfd.

#### RESISTORS

- R1—2,000 ohms, 1 watt
- R2—100,000 ohms
- R3—250 ohms, 5 watts
- R4—20,000 ohms
- R5—5,000 ohms
- R6—250,000 ohms
- R7—1 meg.

#### MISCELLANEOUS

- T1—3½ to 1 ratio, input transformer

ALLEN FORD,  
Portneuf, Quebec, Canada

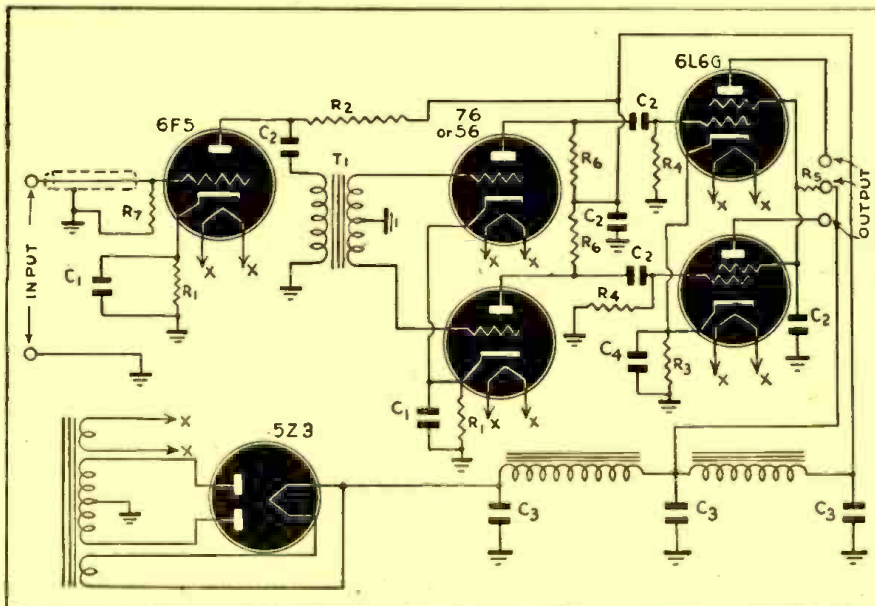

## VOLUME CONTROL FOR SPEAKERS

Independent volume control of extension or main speaker can be accomplished as shown in diagram.

Resistors R1 and R2 (R1 being the series element and R2 the parallel element) are two potentiometers ganged and so

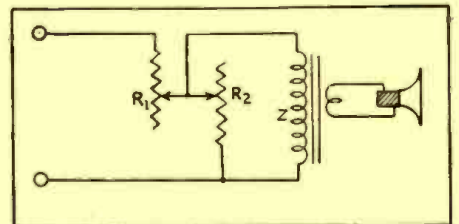

connected that when the resistance of one is decreased, the resistance in the other is increased.

Resistor R2 should have a value of at least 5 times the impedance of the speaker whose volume is being controlled.

R1 has a value equal to the combination of R2 and speaker impedance, or:

$$R1 = (R2 + Z)$$

$$R1 = \frac{5}{5}$$

If Z is 500 ohms, then R2 will be:  
(500) (5) = 2500 ohms

and

$$R1 = \frac{(2500 + 500)}{5} = 600 \text{ ohms}$$

As the potentiometer R2 is connected in parallel with the speaker input, some power will naturally be consumed by it. Although not serious, it may be reduced by increasing the ratio of R2 to Z from 5 to some greater value, say, 10. Resistance R2 then would be:

$$(500) (10) = 5000 \text{ ohms}$$

While R1 would be:

$$(5000 + 500)$$

$$= \frac{5500}{10} = 550 \text{ ohms}$$

In this case, the power consumed by R2 would be one half that consumed by the previous example, where the ratio of R2 to Z was 5.

A. P. K. BELL  
Phila., Pa.

## 6C8G CIRCUITS

Following are two diagrams employing the same 6C8G dual purpose tube. In the

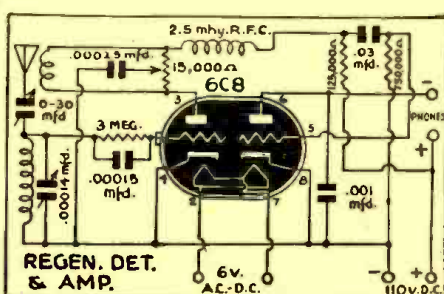

first diagram the 6C8G tube acts as a regenerative detector and rectifier. With this receiver and without an antenna I have logged a large number of stations. The British stations came in nightly. The regeneration control is somewhat critical.

In the second circuit, the tube acts as a regenerative detector and amplifier, fed by a power supply delivering 100 volts. I was able to get British stations, despite poor weather conditions.

On the broadcast band the stations came in with very good volume when using an eight-inch speaker.

I would like to hear from anyone who is interested in these receivers, builds them and experiments with them as I have done. A lot

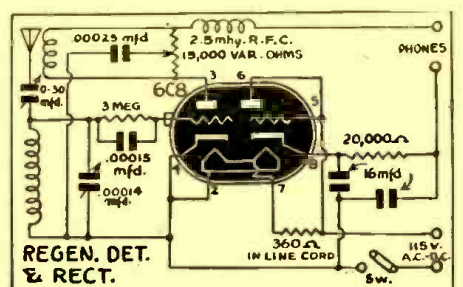

can be learned with simple receivers.

JOSEPH LAZZERI  
Brooklyn, N. Y.

**SARNOFF REVIEWS RADIO YEAR**

"No year in radio history was so packed with activity in communication and scientific research as was 1942," according to Col. David Sarnoff, president of Radio Corporation of America.

"New inventions and important developments, which in normal times would require years to reach practical service, have been rushed to completion in a few short months to meet the demands of war. The scientific achievements of radio in 1942 remain military secrets.

"The press has published photographs of great ships being launched, massive tanks rolling down the production lines, fighter and bomber planes roaring aloft to combat, destroyers and submarines protecting great convoys and Rangers attacking enemy-entrenched beaches. These pictures reveal that the warring monsters manoeuvre with remarkable precision. But the pictures give little or no clue that radio is an important segment in the brain of these engines of war. An antenna is usually the only evidence that radio is aboard. Yet, it is radio which gives these armored monsters their ears and eyes, and even their sense of direction.

"Radio coordinates and speeds modern military action; it is the one factor which has made *blitz* possible in warfare, and then made possible the effective defense against that blitz. Radio in itself is speed. It travels at the speed of light. Its wavelengths cannot be cut, bombed or blasted. A 'walkie-talkie' can project a message into the air from underbrush, from a forest, or a hill top. No power on earth can stop its magic flight.

"The application of radio frequency heating to speed-up industrial processes, and at the same time increase their efficiency, is rapidly coming to the fore. Radio waves may now be used to heat, dry, glue, stitch, anneal, weld, rivet; even to deactivate enzymes.

"This new field is known as *thermal radio*. It can laminate an airplane propeller in minutes, compared to the hours required by ordinary heat and pressure methods. Radio high-frequency 'furnaces' are a post-war prospect. In them railroad ties will be seasoned quickly, and 'cakes' of textiles dried uniformly. Even rubber may be 'radio-cemented,' to wood or plastic; cloth stitched and seamed by radio heat; metals hardened; plywood glued; and fresh vegetables deactivated without loss of flavor or color. The possibilities in this new thermic realm of radio are unlimited as indicated by remarkable advances in the RCA Laboratories during the year."

**RCA UNIFICATION**

The RCA Manufacturing Company, wholly-owned subsidiary of Radio Corporation of America, was consolidated with the parent company, effective December 31, 1942, David Sarnoff, RCA president, announced last month.

The RCA Manufacturing Company has approximately 30,000 employees, and is now chiefly engaged in producing radio equipment vital to the war effort. Its principal plants are located in Camden and Harrison, N. J., Indianapolis, and Bloomington, Indiana, Lancaster, Pa., and Hollywood, Cal. The manufacturing organization will be known as the RCA Victor Division of Radio Corporation of America.

**FREE!**

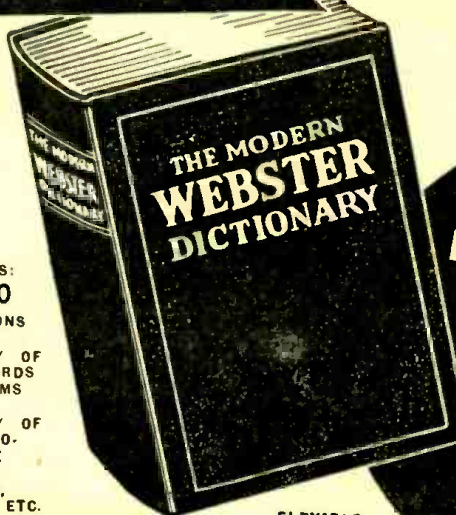

CONTAINS:  
**22,000**  
 DEFINITIONS  
 •  
 DICTIONARY OF  
 RADIO WORDS  
 AND TERMS  
 •  
 DICTIONARY OF  
 THE AUTO-  
 MOBILE  
 •  
 TABLES,  
 TREATISES, ETC.

FLEXIBLE  
 IMITATION  
 LEATHERETTE  
 COVER, SIZE 5 1/2"x8"

with \$1.00 subscription  
 to

**RADIO-CRAFT**

**FULL  
 LIBRARY SIZE  
 MODERN  
 WEBSTER  
 DICTIONARY  
 416  
 PAGES**

**FILL OUT - MAIL THIS COUPON TODAY!**

RADIO-CRAFT, 25 West Broadway, New York, N. Y.  
 This is a New Order  Extend my present subscription  
 Gentlemen: Enclosed you will find One Dollar for which enter my subscription to RADIO-CRAFT Magazine for Seven Months. Send me, ABSOLUTELY FREE and POST PAID, my copy of the MODERN WEBSTER DICTIONARY.

Name ..... Please print clearly

Address .....

City ..... State .....

(Remit by check or money order; register letter if you send cash or unused U.S. Postage Stamp) RC-2-43

**RADIO-CRAFT**  
 25 WEST BROADWAY NEW YORK CITY

**FIVE-TUBE RECEIVER FROM JUNK PARTS**

Following is a diagram of a little set that works fine. I made it out of parts taken from old unused radios.

**Parts List**

- CONDENSERS**  
 C1, C2—240 mmf. ganged with trimmers C3, C4  
 C5—.1, 200 V.  
 C7—.001 mfd., mica  
 C8—.01 mfd., 600 V.  
 C9—.5 mfd., 600 V.  
 C10, C11—8 mfd., 450 V.  
 C12—10 mfd., 150 V.  
 C13—.05, 600 V.
- RESISTORS**  
 R1—150,000 ohms, 1 Watt

- R2—5 megohms, 1 Watt  
 R3—125,000 ohms, 1 Watt  
 R4—50,000 ohms, 1/4 Watt  
 R5—0-50,000 ohms, volume control with 110 Volt switch  
 R6—1500 ohms, 10 Watts

- MISCELLANEOUS**  
 CH—25 henry choke, 90 ma.  
 T1—Power transformer, 2.5 volt, center tapped; 700 volts center tapped, 5 volt, pri. 110 volts  
 T2—3:1 ratio transformer  
 One R.F. coil on broadcast band for 240 mmf.  
 One broadcast band antenna coil, 240 mmf.  
 One output transformer matching speaker (5")  
 Five tubes—one 80; one 24A, one 45, two 80

BOBBY HARRIS,  
 Sunnyside, Ky.

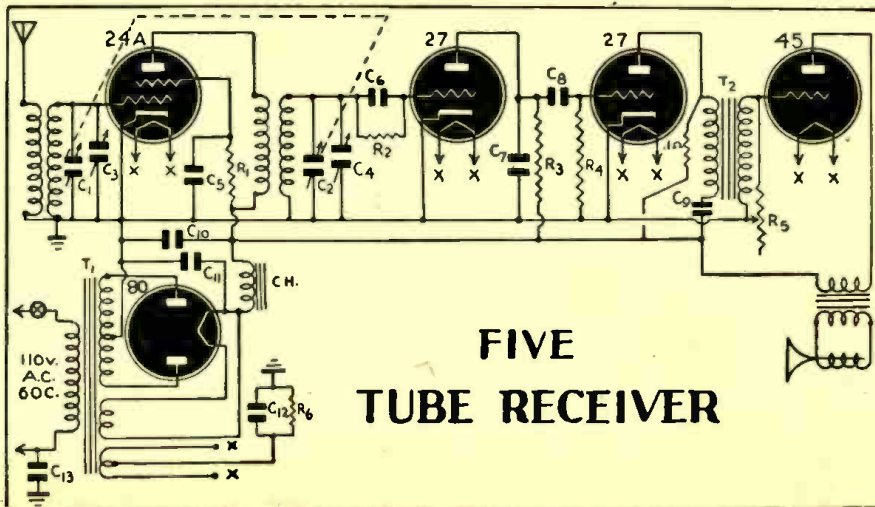

**FIVE  
 TUBE RECEIVER**

# RADIO HOOK-UPS.



Good pay, adventure, interesting work! Army, Navy and Commerce need thousands of men who can send and receive Radiotelegraph Code. Learn Code at home or improve your proficiency and rating through the famous Candler System... the same easy, simple system used in training Radiotelegraph Specialists in Signal Corps, Navy, Marines, Coast Guard, Naval Reserve, Airlines and Amateurs. Quality quickly. No long-drawn-out studies. Candler System established over quarter century. Candler has trained world's champions, experts in telegraph communications, can give you fast sending and receiving technique. Tremendous new field for operators both in and out of Armed Services. Instruction for beginners and operators. You can learn code or increase your w.p.m. speed and improve proficiency. We help you qualify in half the usual time for amateur or commercial license and a good rating.

Write today for FREE Candler Book of Facts. It costs you nothing.

## CANDLER SYSTEM CO.

P. O. Box 928 Dept. 3-B  
Denver, Colorado, U.S.A.  
Craven House, 121, Kingsway, London, W.C. 2

## LEARN CODE the way you'll be using it by SOUND



The best way to learn to read code is by listening to code. The best way to learn to send code is by hearing your own sending repeated back to you. With the new All-Electric Master Teleplex Code Teaching Machine, you learn code the natural, easy, fascinating way. Only instrument ever produced

which records your sending in visible dots and dashes—then SENDS BACK your own key work at any speed you desire. There are NO PERFORATIONS—NO INK. Far superior to anything ever developed... a marvel of simplicity. That's why practically every school teaching code uses TELEPLEX. We furnish complete course, including the All-Electric Master Teleplex. Give your personal instruction with a MONEY BACK GUARANTEE—all at a surprisingly low cost. Write today for FREE catalog 58. No obligation.

107 HUDSON ST.  
TELEPLEX CO., JERSEY CITY, N. J.

## COMMERCIAL RADIO INSTITUTE

A radio training center for over twenty years. Well equipped. Excellent faculty. Practical resident courses in Defense, Radio Telegraphy, Broadcast, Servicing, Industrial, Television, Aeronautical, Drafting, Mathematics and Studio Technique. Placement bureau. Classes now forming. Catalog upon request.  
Dept. D, 38 West Biddle Street, Baltimore, Md.

## STABILIZED OSCILLATOR

An improved oscillation generator which in addition to positive feedback at oscillating frequency, provides a negative feedback at all other frequencies is described by F. E. Terman. To prevent distortions at the fundamental frequency, due to the positive swings of the grid, a diode is connected in series with a biasing battery for limiting the amplitude of the swing independent of the grid current.

In the circuit shown, the cathode of the triode 10 is connected to resistance 14 and

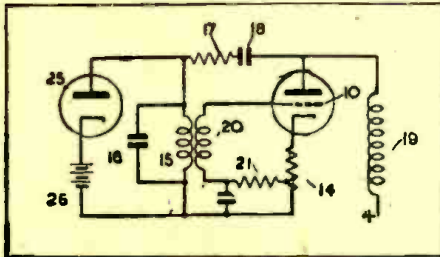

the other end through coil 15 of the tuned tank circuit, resistance 17 and condenser 18 to the anode. The tank circuit 15, 16 is tuned to the operating frequency of the oscillator. Positive voltage feedback for existing oscillators in the generator is made over the lead through the inductance coil 15 to the secondary coil 20 and connected to the grid of tube 10.

The other end of 20 is connected through resistance 21 to an intermediate point on the cathode resistance 14. The grid bias is furnished by the d.c. voltage drop between the cathode and where 21 connects to 14. The voltage drop gives a negative feedback voltage.

A diode connected across the tank circuit is provided with a delay biasing battery 26. This circuit serves to limit the amplitude of the oscillations generated by valve 10, the required limitation being produced by the grid current. This action necessarily increases the distortion of the generated wave.

Diode 25 is biased to such a potential that before the grid valve 10 tends to become positive, valve 25 breaks down so as effectively to short circuit the tank circuit.

The amplitude of the oscillations is limited independently of the grid swing so that the oscillator may work on a straight line portion of its characteristic curve. With this arrangement, most of the distortion in wave form results from the non-linear action of the diode and this will be small if the biasing battery is adjusted so that oscillations with the smallest possible amplitude can just be sustained.

Electronic Engineering, London

## HOME MADE PHOTO VOLTAIC CELL

A lot of experimenters may be interested in making a photo-electric cell which requires no relay.

This cell changes varying light intensities into electrical impulses by varying the potential between the electrodes of a primary cell.

The solution is made by adding 1 oz. of lead nitrate crystals to 1 gill of distilled water (4 gills = 1 pt.). An ordinary pickle bottle is used for a container.

The electrodes used are a lead strip 1/2 by 6 inches and a copper plate 1 by 4 inches.

Heat the copper plate in a flame until the entire surface is coated with a black flaky substance called cupric oxide. (Use a blue flame instead of a yellow one, to avoid a deposit of soot.—Editor)

Now wash the plate in a weak solution of ammonia water to dissolve the cupric oxide. This leaves a golden brown coating of cuprous oxide, which is light-sensitive.

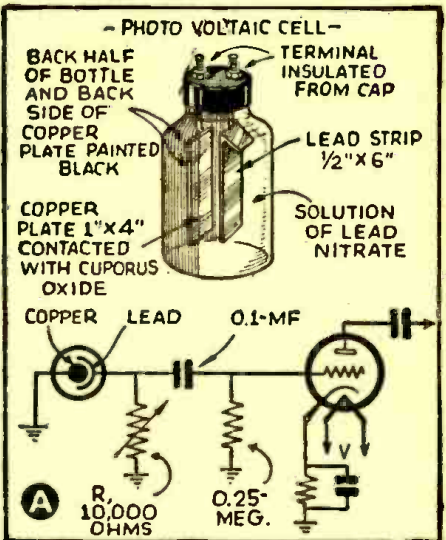

The back half of the pickle bottle and the back side of the copper plate should be painted with black lacquer.

DONALD ROBERTS,

## V. T. VOLTMETER

Here is a diagram of a simple vacuum tube voltmeter, 40 to 1 ratio, that is, only 1 volt will be read on the meter at 40

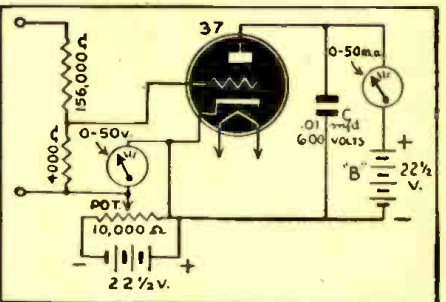

volts. If the meter reads 3 volts then 120 volts would be correct.

The V1 is a 37 tube. V is an 0-50 voltmeter. M is an 0-50 milliammeter. The 10,000 ohm potentiometer is wire-wound type. Condenser C is 0.1 mfd 600 volt.

J. E. BERG  
Pequot Lakes, Minn.



## Are you interested in SOUND MOTION PICTURE PROJECTION?

SUBSCRIBE to INTERNATIONAL PROJECTIONIST, the only magazine published that is devoted exclusively to the mechanical and electrical principles of professional sound motion picture projection. It deals with the arc lamp, film projector, sound track, photoelectric cell, sound amplifier, maintenance and repair of projection equipment, and with every detail of high-calibre, professional motion picture projection. I. P. has the endorsement of leading projection supervisors of the United States and Canada.

INTERNATIONAL PROJECTIONIST  
19 West 44th St., N. Y. C.

1 year—12 Issues—\$3  
2 years—24 Issues—\$5  
(Foreign—50c per year extra)

Name

Address

# RADIO CIRCUIT MANUAL - 1941

**The Only EDITED Manual  
Ever Published!**

**MORE INFORMATION IN HALF THE  
NUMBER OF PAGES**

**DIRECTORY OF RECEIVERS MANUFACTURED  
IN 1940 AND UP TO JUNE, 1941**

## A "CUSTOM-TAILORED" MANUAL FOR SERVICE ENGINEERS

Here, at last, is a Service Manual deliberately PLANNED for the Service Engineer. Instead of a mere hodge-podge collection of service data, as manuals have been in the past, this RADIO CIRCUIT MANUAL is an orderly compilation of essential radio diagrams and service information, carefully edited and uniformly presented for the maximum convenience of the busy Service Engineer. All time-consuming, non-essential data have been weeded out, and the remaining information, vitally important to the rapid and efficient servicing of modern radio receivers, has been laid out in a logical, easy-reading style which cuts time from the day's work. Because of this and other features which are self-evident upon first observation, it has been possible to list all information pertaining to a given model on a single page.

In 736 pages this Manual presents essential service data on over 1800 receiver models;—more than any other existing service manual on the market!

### OUTSTANDING FEATURES

- Contains data on more than 1800 receiver models!—more than any other radio service manual.
- Only 736 pages!—less than half the bulk of any other manual and more than 1/3 lighter.
- All information is EDITED!—all non-essential data deleted and the balance checked and correlated with the schematics and sketches.
- 40% larger page permits listing of all information on one page. (A few unavoidable cases excepted.)
- I.F. peaks for all superhet circuits are boldly displayed in black boxes;—none missing, all accurate.
- No space wasted on communications and export receivers, amplifiers, electronic musical instruments, etc.—a 100% Service Engineer's Manual.

736 pages; size 13% x 10% x 2 in. thick; loose leaf, leatheroid-covered stiff binder; net weight 6½ lbs.



**ORDER YOUR MANUAL  
IMMEDIATELY — NOW!**

**ONLY  
\$10.00**

## \$5.00 POSTPAID VOLUME TWO OF THE OFFICIAL REFRIGERATION SERVICE MANUAL

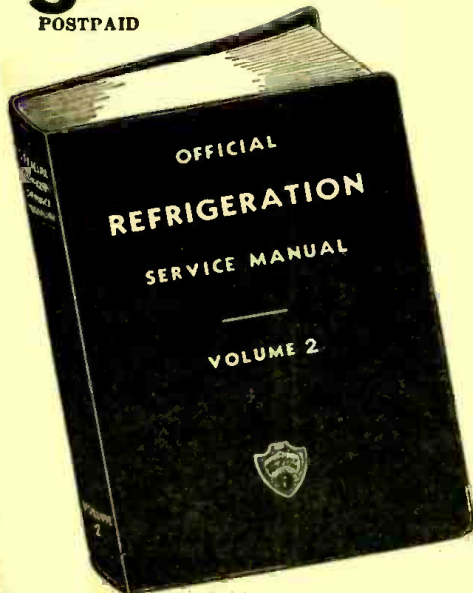

This volume of the Official Refrigeration Service Manual (Volume 2) contains service data and information of value to everyone interested in refrigeration. Although it was published in 1935, there has been a tremendous demand for it, especially during the last year, because of the discontinuance of new models for the duration of the present emergency and the necessity of servicing all old refrigerators and keeping them in service as long as possible.

### Partial Contents in Second Volume of "Official Refrigeration Service Manual"

- Theory and Fundamental Laws
- Methods of Refrigeration
- Refrigerants, Lubricants and Brines
- Handling and Storage of Refrigerants
- Compression System of Refrigeration
- Liquid Throttle Devices
- Refrigeration Systems
- Electric Control Devices
- Compressors, Types, Seals, Valves, Capacities
- Evaporators and Cooling Units
- Service Tools
- Commercial Unit Specifications
- Servicing Refrigeration Apparatus
- Servicing Low Side Float Valve Systems
- Servicing High Side Float Valve Systems

Servicing Expansion Valve Systems  
Servicing Thermostatic Valve Systems  
Servicing Restrictor and Capillary Tube Systems  
Charging Systems with Refrigerant  
Electrical Service; Motors, Fuses, Hookups  
Estimating Refrigeration Loads

**OVER 350 PAGES  
OVER 300 DIAGRAMS**

### Flexible, Looseleaf Leatherette Binder

This Refrigeration Manual is printed on a special Bible stock. This stock, although unusually thin, is exceptionally strong and durable. It makes handling of the book much easier.

RADCRAFT PUBLICATIONS, INC.  
25 WEST BROADWAY, NEW YORK, N. Y.

Gentlemen: Enclosed find my remittance for which send me, POSTPAID, the book (or books) I have checked!

RADIO CIRCUIT MANUAL—1941—\$10.00

REFRIGERATION SERVICE MANUAL vol. 2—1935—\$5.00

Name .....  
Please print clearly

Address .....

City .....

RC-2-43

# RADIO HOOK-UPS

## PROTECTING THE VOICE AND EARS OF OUR FIGHTING FORCES

Lives—Victories—depend on the proper performance of the radio equipment which is the voice and ears of our fighting forces. Army and Navy technicians depend on the same accuracy, dependability and ease of operation which have made the name Supreme famous for over 14 years.

Supreme Radio Testing Instruments keep communications open.

**SUPREME** GREENWOOD, MISSISSIPPI U. S. A.  
TESTING INSTRUMENTS



## NEW CATALOG

OF SOUND AMPLIFYING SYSTEMS

AUDIOGRAPH Sound Systems represent the latest in Public Address equipment—a complete line plus pre-tested accessories.

## NEW LOWER PRICES

Outstanding quality and performance at prices that help you meet any competition.

WRITE FOR YOUR FREE COPY

## AUDIOGRAPH

THE FIRST NAME IN SOUND

Radio Back Industries—Liberty St. Pennsylvania Ave., Plymouth, Ind.

# Complete Plans

For Building Useful and Practical Things at Home. Each issue of Popular Homecraft is crammed with plans for making such beautiful and useful things as: Furniture, Bird Houses, Lamps, Outdoor Garden Furniture, Candle Equipment, etc. Covers lathe work, tools, wood-working, leathercraft, copper. You'll find "how" to make almost everything from the pages of Popular Homecraft. Scores of drawings and photographs make every step simple as A B C. A real "How-To-Do-It" magazine.



Six Months' Trial \$1.00

Send \$1.00 today for trial six months' subscription Money Back If Not Delighted.

## POPULAR HOMECRAFT

937 Palmolive Building Chicago, Ill.

**Trial 6 Months \$1.00**

## OPPORTUNITY AD-LETS

Advertisements in this section cost 15 cents a word for each insertion. Name, address and initials must be included at the above rate. Cash should accompany all classified advertisements unless placed by an accredited advertising agency. No advertisement for less than ten words accepted. Ten percent discount six issues, twenty percent for twelve issues. Objectionable or misleading advertisements not accepted. Advertisements for March, 1943, issue must reach us not later than February 10, 1943.

Radio-Craft • 25 W. B'way • New York, N. Y.

RADIO SERVICEMEN AND EXPERIMENTERS SEND for our giant radio catalogue. Save dollars. United Radio Co., (1000P) Newark, N. J.

WANTED: RIDER'S MANUALS. TUBE TESTER. PREFFER Hiekok 530P. State price, condition. Robert Wendt, 507 South Thirteenth St., Saginaw, Michigan.

## USED Correspondence Courses

Illustrated bargain catalog FREE. Write today! NELSON COMPANY, 500 Sherman, Dept. B-210, Chicago

COMPLETE HOME-STUDY COURSES and self-instruction books, suitably used. Sold, rented, exchanged. All subjects. Satisfaction guaranteed. Cash paid for used courses. Full details and 84-page catalog FREE. Write today!

## A "MIL" METER

Almost all junk boxes contain an old Jewel voltmeter. From one of these, I made an accurate meter.

Revamping the meter is not a difficult job, but care must be taken in order not to damage the meter.

The idea is to remove the multiplying coil and to shunt the moving coil. The shunt is made of a short length of rheostat wire and the length is found by trial.

The "mil" scale may be made to correspond with the voltage scale, but a new scale can be made if desired.

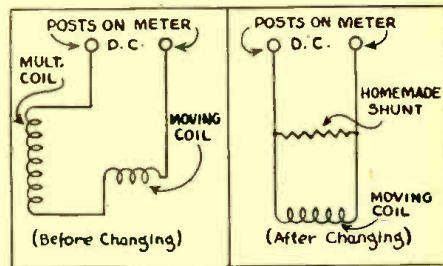

have on hand. It should be checked if some kind of accuracy is to be obtained.

The shunt is adjusted to give the desired coverage, and is soldered in place to prevent any loss of adjustment.

MERLE EICHENFELD  
Sand Springs, Okla.

The scale or coverage of the meter is determined by checking the readings against a Triplet or similar meter which one may

## THE SASKATCHEWAN SPACE-CHARGER

The diagram shows a one-tube receiver employing a 1A5GT tube. I have already worked out a form of regenerative control (a volume control is used, or a tuning condenser, to make it more selective).

This set may be operated from a power pack with plenty of volume, in fact too much. I cannot read the code of the phone condenser, however I believe it might be a .005.

I hope you have the diagram clear and can start wiring it to see how splendidly it performs.

It is a worthwhile experiment for a good technician to try.

When you have it all set and ready to go, get it set on your loudest station, then try a speaker on it and I am convinced you will be delighted with all the pep that one tube can furnish.

JOSEPH NIWRANSKI  
Brooksby, Sask.

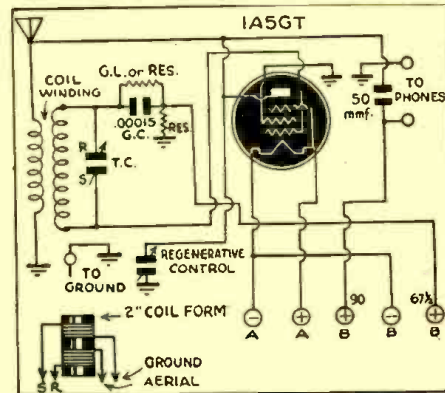

# WE "HEAR" WHAT WE NEVER HEAR

SOME years ago a well-known radio writer pointed out that what some of his friends called a "good bass" in their radios was nothing more than the brain supplying the sensation of a low note which was not heard by the ear nor even emitted by the radios of the time.

The statement essentially, was, that "what my friends heard, was not 30, 40 or 60 cycle tones, but the 120 cycle tone, and they thought they heard organ pedal tones."

Also it is well known in acoustics that if great force or a sudden force is applied in setting a string, diaphragm, tube or air column vibrating, the tone emitted is richer in harmonics than when a small force is applied.

Perhaps with such data as these as a basis, Mr. Louis A. DeRosa has investigated the possibility of supplying bass notes and tones over 5000 cycles, to radios, particularly those of the cheaper variety.

For the last month, before the Radio Club of America, Mr. DeRosa demonstrated that the ear "hears" what it does not hear. For example, we "hear" a cricket chirp. The chirp is about 16,000 cycles, but the limit of average hearing is about 5000 cycles. It is the brain which supplies the sensation of hearing the 16,000 cycle chirp. This would indicate that what the ear misses, the brain supplies. Or, to put it another way, the vi-

brations received by the ear are passed on to the brain as suggestions.

Another idea which Mr. DeRosa demonstrated was percussion. Not in the bass drum, triangle, and cymbal sense, but in its physical sense of a "sudden force". This sudden force applied in music for instance, might be the "sfzorzando". Rich tonal effects are achieved that way, as is well known among musicians and composers.

Something along this line is the idea of Mr. DeRosa's, that if these rich harmonies could be supplied at the broadcast station, the listener could hear them without changing his present radio.

Combining this idea with his high-note and percussion gains, Mr. DeRosa points out that the cheap sets in the future will equal or surpass the best sets of today, because only frequencies of 150 to 4000 cycles need be passed.

Most of the heavy equipment now called for is due to its being needed to bring out the low notes.

Since his arrangement can be applied right at the broadcast station without making any changes in existing receivers, the idea could be put into effect at once; but Mr. DeRosa's war work prevents his devoting any effort to his revolutionary device commercially at the present time.



in his room at the Hotel New Yorker by the floor maid who reported the death.

Having been born in Yugoslavia, the Yugoslav Government in exile gave Tesla a state funeral. He was buried, after a service at the Cathedral of St. John the Divine, on January 14th. Over 2,000 people attended the rites.



Commemorative postage stamp by Yugoslavia to honor the famous scientist on his 80th birthday, in 1936.

High Government officials of the Yugoslav Government attended the funeral. Honorary pallbearers included Dr. Ernest F. W. Alexander, well-known inventor of the Alexander alternator, of General Electric Company; Professor Edwin H. Armstrong of Columbia University, inventor of the Superheterodyne and Frequency

Modulation; Dr. Harvey C. Rentschler, director of the research laboratories, Westinghouse Electric and Manufacturing Company; and hundreds of others of the Radio and allied industries. The body was taken to Ferncliffe Cemetery, Ardsley, N. Y., where it will lie in the receiving vault until final plans for burial are completed.

Many telegrams were received from dignitaries the world over. These included a telegram from King Peter II, and a telegram from Mrs. Franklin D. Roosevelt as follows: "The President and I are deeply sorry to hear of the death of Mr. Nikola Tesla. We are grateful for his contribution to science and industry and to this country."

Many honors were heaped on Tesla during his lifetime. A list of the outstanding ones follows: Hon. M.A. Yale University, 1894. L.L.D. Columbia University, 1894. D.Sc. Vienna Polytechnic. He received the Elliott Cresson gold medal in 1893 in recognition of his original pioneer work, first presented before the Franklin Institute and the National Electric Light Association.

The Yugoslav Government honored him by issuing a series of Tesla postage stamps on his eightieth birthday in 1936. At the same time all the Yugoslav schools held a science festival in honor of Nikola Tesla.

**TESLA AND HIS INVENTIONS**

Tesla was the inventor of innumerable far-reaching basic inventions. Indeed, he made over 1,000 different inventions, 900 of which he patented during his long and eventful life.

In many ways Tesla's inventions were so far ahead of the times that even we of today are not able to fully appreciate the tremendous work which the master inventor accomplished. Many of his inventions will no doubt become more important as time goes on, and it is certain that posterity will realize the value of Tesla's accomplishments far more than does the present generation.

It is impractical here to give the long roster of all the hundreds of various inventions of Nikola Tesla. He was an inventor whose ideas were so far ahead of his time that many of these inventions could not be utilized at the time they were made, because frequently the arts had not caught up with his inventions—with the usual result—that late-comers often derived the benefit of his earlier work.

Thus it came to be that Nikola Tesla, who originally earned the name of "The Father of Wireless," obtained no financial reward from his early work, although dozens of his inventions were used to make radio what it is today. By 1900 Tesla had

**NIKOLA TESLA**  
(Continued from page 264)

patented a wireless system, much of which was used later on to make commercial wireless possible. As early as the year 1893, Tesla, before the Franklin Institute and Electric Light Association, (in February and March 1893) demonstrated the means of wireless transmission and reception. Tesla was the first who used an elevated capacity (aerial) at the transmitter side and a similar capacity at the receiver. The illustrations reproduced elsewhere in this article show the means he used to accomplish this. These very means were used by Marconi and others who came much later and who appropriated Tesla's ideas.

To the end of his days Nikola Tesla maintained that the Marconi wireless system was an infringement on his methods and apparatus for transmitting energy without wires. Tesla in due time brought suit against Marconi but he could not establish his patent rights and blamed his failure to the paucity of technical knowledge of the times, of the lawyers and the court. Tesla could not make himself understood at that time, on the difference between wave lengths, particularly between micro-waves and short-waves. When, many years later his language had become clear—even to a mediocre technician—his original patents had run out. Nevertheless, there would have been no wireless transmission without Tesla's fundamental work.

Again Tesla caused a world-wide furor in the early 90's with his Colorado experiments. He erected a large experimental plant for the express purpose of carrying on his researches in high frequency, high-power electric currents. It is believed that he was the first man to reproduce artificial lightning. He did so as early as 1890 when he built the Tesla electric oscillator which produced twelve million volts at a frequency of 100,000 alternations per second. The primary used over 300 kilowatt. Lightning in huge sparks, thrown over a distance of 22 feet, created such an electrical disturbance

in the surrounding earth, that one inch sparks could be drawn from grounded metal objects 300 feet from the laboratory. A little later, with the same system, Tesla obtained lightning-like sparks over 100 feet long.

Tesla wrote a number of articles of a biographical nature entitled, "My Inventions." These were printed in the magazine "ELECTRICAL EXPERIMENTER" published at that time by the writer. In the May 1919 issue of that magazine, there was shown a little-published photograph of a large metal sphere which showed a Niagara of lightning-like sparks with the following caption:

"This illustrates Tests With Spark Discharges From a Ball of Forty Centimeters Radius in Tesla's Wireless Plant Erected at Colorado Springs in 1899. The Ball is Connected to the Free End of a Grounded Resonant Circuit Seventeen Meters in Diameter. The Disruptive Potential of a Ball is, According to Tests, in Volts Approximately  $V = 75,400 r$  (r being in Centimeters). That is, in This Case  $75,400 \times 40 = 3,016,000$  Volts. The Gigantic Tesla Coil Which Produced These Bolts of Thor Was Capable of Furnishing a Current of 1,100 Amperes in the High Tension Secondary. The Primary Coil Had a Diameter of 51 Feet! This Tesla Coil Produced Discharges Which Were the Nearest Approach to Lightning Ever Made by Man."

In his epoch-making Colorado experiments, in the year 1898, Tesla was the first to transmit actual energy by wireless. He succeeded in lighting electric lamps at a distance of over half a mile without any intervening wires. These were his famous electric high-frequency demonstrations in which most of the wireless energy was transmitted through the earth.

Tesla maintained to his death, that our present-day conception of radio waves transmitted through space is wholly wrong. He always denied the existence of free radio waves in space. His theory was that everything in radio could be explained by earth conduction. The writer once asked him how he could explain transmission of radio signals to and from an airplane. His answer was characteristic of him; his ex-

(Continued on page 308)

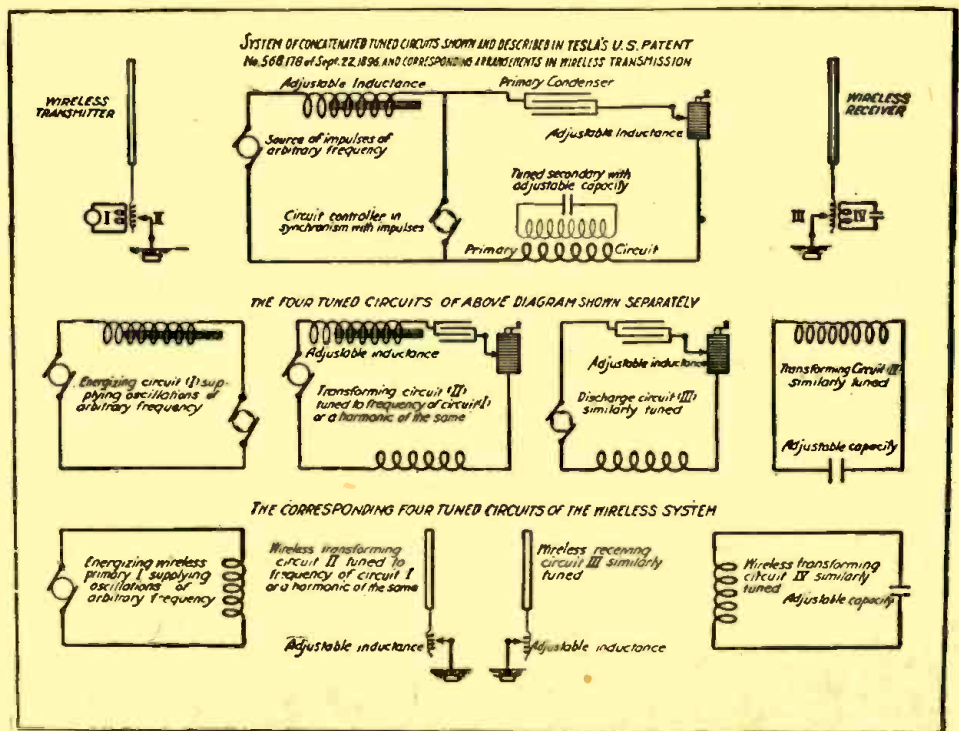

Tesla's system of concatenated tuned circuits shown and described in U. S. Patent No. 568,178 of September 22, 1896, and corresponding arrangements in wireless transmission.

planation was "a plain condenser action." To Tesla's mind transmission took place simply by considering the airplane as one plate, the earth as the other plate of a condenser. Modern scientists do not agree with him in this respect, but all this does not decrease Tesla's fame.

To name only a few of his more outstanding and well-known discoveries, we may quote these:

One of his first inventions was a telephone repeater, but the one invention which brought him most of his fame was undoubtedly his revolutionary alternating current induction motor, which used neither commutator nor brushes. This invention was made in 1888, when practically only direct current motors were used. The induction motor is used throughout the world today.

He next invented his well-known system of electrical conversion and distribution by oscillatory discharges. In 1891 the now world-famous Tesla coil or transformer was invented. This really was the forerunner of wireless and the Tesla transformer with its condenser and methods of tuning all were then used, and much of it still is being used today, as it was in the early days of wireless.

In 1893 Tesla devised a system of wireless transmission and intelligence. Shortly thereafter he published his work on mechanical oscillators and generators of electrical oscillations. At the close of the century, Tesla did a tremendous amount of research work and made many discoveries in the field which we now call electronics. His work dealt with radiations in vacuum, with material streams and emanations. This included his now famous Tesla "cold" light which was the forerunner of our present neon lights and others.

In the year 1900 Tesla, backed by John Pierpont Morgan the elder, built his now famous Tesla Tower on Long Island. This fantastic appearing steel tower, 189 ft. high, was popularly known as a wireless tower but there was little technical information about it for many years.

In 1919 the writer asked Nikola Tesla to give a history of his tower which he did in a signed article entitled: "The Magnifying Transmitter." This was published in the "ELECTRICAL EXPERIMENTER," May 1919 issue. An excerpt follows:

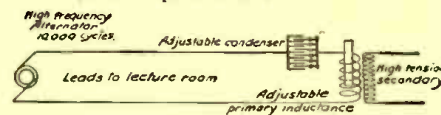

Diagram illustrating the circuit connections and tuning devices employed by Tesla in his experimental demonstrations before the American Institute of Electrical Engineers.

**The Magnifying Transmitter**

"I have been asked by the ELECTRICAL EXPERIMENTER to be quite explicit on this subject so that the readers of the magazine will clearly understand the construction and operation of my 'Magnifying Transmitter' and the purposes for which it is intended. Well, then, in the first place, it is a resonant transformer with a secondary in which the parts, charged to a high potential, are of considerable area and arranged in space along ideal enveloping surfaces of very large radii of curvature, and at proper distances from one another thereby insuring a small electric surface density everywhere, so that no leak can occur even if the conductor is bare. It is suitable for any frequency, from a few to many thousands of cycles per second, and can be used in the production of currents of tremendous volume and moderate pressure, or of smaller amperage and immense electro-motive force. The maximum electric tension is merely dependent on the curvature of the surfaces on which the charged elements are situated and the area of the latter.

"This invention was one of a number comprised in my *World-System* of wireless

**NIKOLA TESLA**

(Continued from page 307)

transmission which I undertook to commercialize on my return to New York in 1900. As to the immediate purposes of my enterprise, they were clearly outlined in a prospectus of that period from which I quote:

"The *World-System* has resulted from a combination of several original discoveries made by the inventor (Tesla) in the course of long continued research and experimentation. It makes possible not only the instantaneous and precise wireless transmission of any kind of signals, messages or characters, to all parts of the world, but also the interconnection of the existing telegraph, telephone, and other signal stations without any change in their present equipment. By its means, for instance, a telephone subscriber here may call up and talk to any other subscriber on the Globe. An inexpensive receiver, not bigger than a watch, will enable him to listen anywhere, on land or sea, to a speech delivered or music

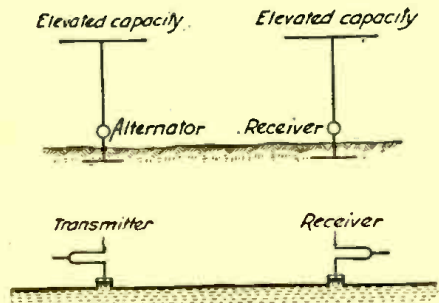

Transmission of electrical energy through the earth as illustrated in Tesla's lectures before the Franklin Institute and Electric Light Association in February and March, 1893 and mechanical analogy of the same.

played in some other place, however distant."

"The *World-System* is based on the application of the following important inventions and discoveries:

"1. The 'Tesla Transformer.' This apparatus is in the production of electrical vibrations as revolutionary as gunpowder was in warfare. Currents many times stronger than any ever generated in the usual ways, and sparks over one hundred feet long, have been produced by the inventor with an instrument of this kind.

"2. The 'Magnifying Transmitter.' This is Tesla's best invention—a peculiar transformer specially adapted to excite the Earth, which is in the transmission of electrical energy what the telescope is in astronomical observation. By the use of this marvelous device he has already set up electrical movements of greater intensity than those of lightning and passed a current sufficient to light more than two hundred incandescent lamps, around the Globe.

"3. The 'Tesla Wireless System.' This system comprises a number of improvements and is the only means known for transmitting economically electrical energy to a distance without wires. Careful tests and measurements in connection with an experimental station of great activity, erected by the inventor in Colorado, have demonstrated that power in any desired amount can be conveyed, clear across the Globe if necessary, with a loss not exceeding a few per cent."

When John Pierpont Morgan died, no more funds were forthcoming for the Tesla Tower and the work was abandoned. The tower was demolished during the first World War by the United States Government who feared that it might be used by the enemy to transmit messages.

The world will always remember Tesla; and we are certain that future generations will be in a better position to appraise Tesla's work than we of today.

NOTE: The radio diagrams shown in this article are taken from an exclusive article writ-

ten for Hugo Gernsback and published in the "ELECTRICAL EXPERIMENTER" of May 1919, entitled: "The True Wireless" by Nikola Tesla.

**EULOGIES OF THE PRESS**

From the hundreds of eulogizing editorials appearing in the press throughout the country, we have selected the three which we consider as outstanding examples of what the American press thought of Nikola Tesla.

From an editorial in the "NEW YORK TIMES":

**"NIKOLA TESLA**

"If ever an inventor satisfied the romantic requirements of a Jules Verne novel it was Nikola Tesla. Communicating with Mars, plucking heat units out of the atmosphere to run engines, using the whole earth as an electrical resonator so that a man in China could communicate wirelessly with another in South America, transmitting power through space—it was to such possibilities that he devoted the last forty years of his long life. His practical achievements were limited to the short period that began in 1886 and ended in 1903.

"And what achievements they were! Poly-phase currents and alternating engineering, applied against the opposition of Lord Kelvin and Edison in the first hydroelectric plant of Niagara Falls, the induction motor, the use of oil in transformers, remarkable work in wireless at a time when Marconi had yet to make his mark, electric arcs fed by direct current in a magnetic field, later applied by Poulsen in the first radiotelephone, gas-discharge lamps which were in some respects the forerunners of the neon lights that now shine on every Main Street, the medical application of high-frequency currents in what he called "Electrical massage"—those crucial seven years of his youth were crowded with triumphs out of which came the whole modern apparatus of high-voltage electrical engineering.

"Yet all this he affected to regard as of minor importance. It was the Jules Verne future that engrossed him, for which reason the last half of his life was spent in the isolation of a recluse. For forty years he lived and worked in a world of fantasy crackling with electric sparks, packed with strange towers to receive and emit energy and dreamy contrivances to give utopian man complete control of nature. It was a lonely life.

"There was a solid scientific basis at the bottom of all this romanticism. For he was no tinkerer, but a first-class mathematician

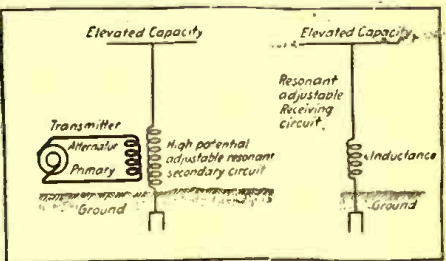

Tesla's system of wireless transmission through the earth as actually exposed in his lectures before the Franklin Institute and Electric Light Association in February and March 1893.

and physicist whose blueprints were plausible, even though they were far ahead of the technical resources of his day. He belongs to the passing age of heroic invention of which Edison was the most distinguished exemplar—the age of technical poets who expressed themselves in generators, inductance coils and high voltages rather than in drama and verse and who were the real architects of this culture. If that abused word 'genius' ever was applicable to any man it was to him."

From an editorial in the "NEW YORK HERALD-TRIBUNE":

**"The Drama of Mr. Tesla**

"Mr. Nikola Tesla, the "wizard," died the other day, and he left a lot of questions unanswered. His solid accomplishments were

astounding in their scope—more than nine hundred patents, including the transforming coil and the induction motor. But, important as were his accomplishments, he deserves attention as a dreamer. He had always been absorbed by glimpses into the world of tomorrow, a world in which power would be transmitted by radio, in which science could make the desert blossom by what would amount to the touching of a button. There was no limit to the range of his imagination. He even envisioned airplanes, fighters and bombers and all, without engines. We cannot know, but it may be that a long time from now, when patterns are changed, the critics will take a view of history that will bracket Tesla with Da Vinci. Or with our own Mr. Franklin. Or with Dr. Loeb, who came close to the secret of life. One thing is sure: This world, as we run it today, did not appreciate his peculiar greatness.

"Mr. Tesla was eighty-six years old when he died. He died alone. He was an eccentric, whatever that means. A nonconformist, possibly. At any rate, he would leave his experiments and go for a time to feed the silly and inconsequential pigeons in Herald Square. He delighted in talking nonsense—or was it? Granting that he was a difficult man to deal with and that sometimes his predictions would affront the ordinary human's intelligence, here, still, was an extraordinary man—a genius he must have been. He was seeking a glimpse into that confused and misty frontier which divides the known and the unknown. Known and unknown? Perhaps it is eternally unknown. But we do know that Tesla, the ostensibly foolish old gentleman, at times was trying with superb intelligence to find the answers. His guesses were right so often that he would be frightening. Probably we shall appreciate him better a few million years from now."

From an editorial in the "New York Sun":

**"Nikola Tesla**

"As an inventor Nikola Tesla had the unusual experience of living for half a century after some of his most important discoveries and developments were announced to the world. He was thus able to see the application, improvement and consequences of a number of basic electrical inventions. Tesla's motor and his system of alternating current power transmission were devised in 1888; three years later he brought out a transformer, and by 1896 was experimenting with wireless. He shares with numerous other inventors, however, the more common experience of advancing some of his scientific ideas long before the world had become sufficiently informed to understand their importance. When we remember that Marconi's radio as a popular interest waited for the 1920's, it is easier to understand how fantastic seemed Tesla's proposals at the turn of the century for transmission of power without wires. In his later years when he appeared to be carried away with scientific notions of a highly impracticable kind, the world forgot the Tesla of fifty years ago, but continued to advance on inventions he had built."

**SERVICING NOTES**

(Continued from page 283)

reversing the loop antenna plugs, situated on the sides of the chassis. Whistling will disappear. This was known to be true on quite a few occasions.

CHESTER E. DRZEWIECHI,  
Arnold, Penna.

**... RCA VICTOR MODEL 10K**

In servicing these receivers for no operation, I have found the 6L6 dead. When replaced with a new tube the tone is very distorted after a few minutes of operation. The trouble is usually found in the output bias changing from about 16 to 25 volts. Replace the 470,000 ohm grid resistor with a 250,000 ohm 1/2 watt resistor and the trouble is cured. This should also apply to any receiver using a 6L6 or 6F6.

F. JORDAN,  
San Antonio, Texas.  
(Continued on page 310)

**WHILE THEY LAST**

All of the attractive items listed here are brand new. ALL are in PERFECT WORKING ORDER. In many cases, the parts alone total more than the price we are asking. 100% satisfaction guaranteed or your money refunded.

ORDER FROM THIS PAGE. Use the convenient coupon below. Include sufficient extra remittance for parcel post charges, else order shipped express, collect. Any excess will be refunded. C.O.D. shipments require 20% deposit. If full remittance accompanies order, deduct 2% discount. Send money order, certified check, new U. S. stamps. No C.O.D. to foreign countries.

ORDER TODAY LIMITED QUANTITIES PROMPT SHIPMENTS ASSURED

**THE SODERWAND  
SUPER SOLDERING IRON**

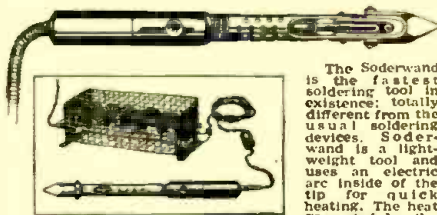

The Soderwand is the fastest soldering tool in existence; totally different from the usual soldering devices. Soderwand is a light-weight tool and uses an electric arc inside of the tip for quick heating. The heat generated by the arc is so intense that within 60 seconds after starting, the copper is hot enough to flow solder. There is a constant surplus of heat which makes quick soldering jobs seem easy. Current consumption is small, as only intermittent current is necessary to keep iron hot. Convenient thumb control cuts current on or off. Simple in design. Burn-out impossible as there is no heating element to burn out.

The Soderwand is an all-purpose tool that takes care of the heaviest or most delicate job with equal ease. IMPORTANT. This is a brand new item and comes in its original packing. We acquired the manufacturer's entire stock, which is the reason why we can sell the tool for so little money. THE ORIGINAL PRICE WAS \$8.00.

Supplied with regular No. 5 pyramid tips, 14 feet of cord, attachments, plugs, resistance unit, and two extra sets of carbons. Made for 110 volts A.C. 60 cycles, or D.C. Size: 13" long. Tool weighs 10 oz. Ship. wt. of outfit 4 lbs.

ITEM NO. 154  
YOUR PRICE ..... \$3.00

**VARIABLE SPEED UNIVERSAL MOTOR  
FOR 110 VOLTS, A.C. OR D.C.**

Made for Dictaphone machines by American Gramophone Co. Used, but in excellent condition. Special lever control permits variable speeds up to 3000 r.p.m. 1/2" shaft extends from both sides of motor. Measures 7 1/2" x 3 1/4" diam. overall. Ship. Wt. 6 3/4 lbs.

ITEM NO. 11  
YOUR PRICE ..... \$2.95

**WESTON MODEL 662  
A.C.-D.C. AMMETER**

Designed by Weston for the Eastman Kodak Co. This is a precision-built magnetic-vane type meter. Range 0-6 amperes. It is 2 inches in diameter and designed for panel mounting. Black-enamelled metal case of excellent finish, bakelite base, scale printed on aluminum sheet. A fine appearing instrument.

ITEM NO. 35  
YOUR PRICE ..... \$1.25

**POWERFUL ALL-PURPOSE INDUCTION MOTOR  
IDEAL FOR EXPERIMENTERS—101 USES**

Sturdily constructed to precision standards, this self-starting shaded pole A.C. induction motor is powerful enough for a large variety of uses. Some of these are: Automatic Timing Devices, Current Interrupters, Electric Fans, Electric Chimes, Window Displays, Photo-cell Control Devices, Electric Vibrators, Small Grinders, Buffers and Polishers, Miniature Pumps, Mechanical Models, Sirens, and other applications. Consumes about 15 watts of power and has a speed of 3,000 r.p.m. When geared down, this sturdy unit will constantly operate an 18-inch turntable loaded with 200 lbs. dead weight—THAT'S POWER!

Dimensions, 3" high by 2" wide by 1 1/2" deep; has 4 convenient mounting studs; shaft is 3/8" long by 3/16" diameter, and runs in self-aligning oil-retaining bearings. Designed for 110-20 volts, 50-60 cycles, A.C. only.

ITEM NO. 147  
YOUR PRICE ..... \$1.45

**WESTERN ELECTRIC BREAST MIKE**

This is a fine light-weight alnico carbon microphone. It weighs only 1 lb.

Mike comes with breast-plate mounting and has 2-way swiveling adjustment so that it can be adjusted to any desired position. There are 2 woven straps; one goes around neck, the other around chest. Straps can be snapped on and off quickly by an ingenious arrangement.

This excellent mike can be adapted for home broadcasting or private communication systems. By dismounting breastplate, it can be used as desk mike.

Comes complete with 6 foot cord and hard rubber plug. Finished in spherulized plate, non-rustable. THIS IS A BRAND NEW MIKE. IT HAS NEVER BEEN SOLD AT SUCH A LOW PRICE BEFORE. ORIGINAL LIST PRICE \$15.00. Shipping weight, 2 lbs.

ITEM NO. 152  
YOUR PRICE ..... \$2.55

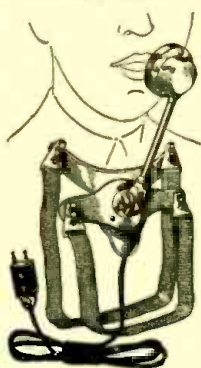

**METAL CUTTING SAW**

Here is an ideal metal-cutting saw made of fine tool steel specially designed to cut metal. Teeth are set at a special double angle for metal-cutting work. Saw is specially hardened for long and extended use; measures 3 1/4" diameter; center hole is 1/2" square; thickness 42/1000 (42 mils.) 3/64".

ITEM NO. 151  
YOUR PRICE ..... 50c

**POWER ADJUSTABLE RHEOSTAT**

Here is an excellent rheostat used especially to regulate speed of small motors, such as our Handy Workshop Outfit. This rheostat can be used in connection with motors up to 1/20 h.p.

This fine rheostat is wire-wound on porcelain insulation. The black enamel steel casing is perforated for ventilation. Adjustable handle regulates speed of motor easily and smoothly. Size 5 1/2 x 3 1/4" overall. Ship. Wt. 2 lbs.

ITEM NO. 153  
YOUR PRICE ..... \$1.45



**AMAZING BLACK LIGHT!!**

Powerful 250-Watt Ultra-Violet Source

The best and most practical source of ultra-violet light for general experimental and entertainment use. Makes all fluorescent substances brilliantly luminous. No transformers of any kind needed. Fits any standard lamp socket. Made with special filter glass permitting only ultra-violet rays to come through. Brings out beautiful opalescent hues in various types of materials. Swell for amateur parties, plays, etc., to obtain unique lighting effects. Bulb only. Ship. Wt. 1 lb.

ITEM NO. 87  
YOUR PRICE ..... \$2.00



**WATT-HOUR METER**

Completely overhauled and ready for immediate service. Designed for regular 110-volt, 60 cycle 2-wire A.C. circuit. Servicemen use it in their shops to check current consumption of sets, soldering irons, etc. Keeps costs down. If dismantled, the parts alone would bring the price. The elaborate gear train could be used as a counter on machines of various kinds. Simple to install. 2 wires from the line and 2 wires to the load. Sturdily constructed in heavy metal case. Size: 8 1/4" high, 6 1/4" wide, 5" deep. Westinghouse or General Electric. Ship. Wt. 14 lbs.

ITEM NO. 33  
YOUR PRICE ..... \$4.95



**HUDSON SPECIALTIES CO., 40 West Broadway, N. Y. C.**

IT'S EASY TO ORDER—CLIP COUPON—MAIL NOW ORDER FROM THIS PAGE.

HUDSON SPECIALTIES CO., 40 West Broadway, Dept. RC-2-43, New York, N. Y.  
I have circled below the numbers of the items I'm ordering. My full remittance of \$..... (include shipping charges) is enclosed. NO C.O.D. ORDERS UNLESS ACCOMPANIED WITH A DEPOSIT.  
OR my deposit of \$..... is enclosed (20% required), ship order C.O.D. for balance. No C.O.D. order for less than \$2.00. (New U. S. stamps, check or money order accepted.)  
Circle Item No. wanted: 11, 33, 35, 87, 147, 151, 152, 153, 154

Name ..... Address .....  
Please Print Clearly

City ..... State .....

Send remittance by check, stamps or money order; register letter if you send cash or stamps.

# • NIKOLA TESLA •

## NIKOLA TESLA

(Continued from page 265)

We say today that in this field he was a prophet ahead of his time; that the instrumentalities for realizing the vision were not yet created, and so the vision faded. True, but what will they say of us who were later to invent and create the instrumentalities with which the vision could be carried out? We could not see it, even though it lay before us on the printed page.

The world, I think, will wait a long time for Nikola Tesla's equal in achievement and imagination.

### FROM THE INVENTOR OF THE ALEXANDERSON ALTERNATOR

DR. E. F. W. ALEXANDERSON, PH.D.; D.Sc.

I KNEW Tesla just enough to get an impression of an amiable personality and a dreamer with his head in the clouds. His invention of the induction motor was the greatest single contribution to the use of electric power but characteristically he left it to others to follow up this idea while he continued to speculate on the transmission of power by electric waves. Marconi took the wave theory and made something practical out of it while Tesla was reaching for the unattainable.

From time to time there appears in the world a great dreamer whose function seems to be to shock more realistic minds into action. Nikola Tesla was one of those.

### FROM THE PROFESSOR OF ENGLISH LITERATURE, EMERITUS, YALE UNIVERSITY

WM. LYON PHELPS, PH.D.; L.H.D.; LL.D.; S.T.D.; D.C.L.

NIKOLA TESLA, whose father was a Greek clergyman and public speaker and his mother an inventor, which talent she inherited from her father, was, of course, educated in Europe, taking honours in mathematics and applied sciences. His first electrical invention was a telephone repeater. He did the United States of America the honour of becoming a resident and naturalized citizen in 1884; for I believe those who choose the United States for

citizenship are really to be praised more than those who are born here. In Dr. Tesla's life one invention followed another. He was a multitudinous blessing to the community, to the country, and to mankind, and his death was a personal loss to all who knew him and a subtraction from the civilized world.

### FROM THE FORMER HEAD OF THE SIGNAL CORPS, CHIEF SIGNAL OFFICER U. S. ARMY, RETIRED

MAJOR GENERAL J. O. MAUBORGNE

SO another of the great pioneers of wireless telegraphy has passed away! Tesla, "the wizard" as he was known in my youth, who captured the imagination of my generation with his flights of fancy into the unknown realms of space and electricity. A "dreamer," as he was called by some, with astounding vision far beyond his contemporaries, very few of whom realized until many years after the work of Marconi, that the great Tesla was the first to work out not only the principles of electric tuning or resonance, but actually to design a system of wireless transmission of intelligence in the year 1893.

Who can read the pages of that authoritative and historical work by T. C. Martin published—please note carefully—in the year 1894, and entitled "Inventions, Researches and Writings of Nikola Tesla" without being impressed with the fact that Tesla, before that date, had already developed coupled high frequency resonant circuits; a system of wireless transmission, wherein, as shown by the diagram in Martin's book, was provided an earthed transmitter system with an elevated aerial radiator, later called an antenna—an arrangement attributed to the great Marconi; a high frequency alternator capable of transmitting intelligence in the spectrum of the longest waves still used in radiotelegraphy; also, a resonator which, if used in the circuit diagrammed, would have permitted antenna tuning, and which, if used today as an antenna system in the high frequency ranges without additional antenna or a ground connection, would most certainly be acknowledged as a radio transmitting sys-

tem by the Federal Communications Commission and ordered licensed?

Let us acknowledge, also, that Tesla was the proponent of the use of stranded fine-conductor cable for high frequency circuits, "invented" in Germany at a much later date.

Careful perusal of Martin's work is highly recommended for radio engineers and historians who know not Tesla as a great pioneer in the field of wireless.

I join most devoutly in the present tribute to his memory.

### FROM THE DIRECTOR OF RESEARCH OF WESTINGHOUSE ELECTRIC & MFG. CO.

DR. HARVEY C. RENTSCHLER, M.A.; Ph.D.; D.Sc.

NIKOLA TESLA will always be remembered for his original development of oscillation transformers now appropriately called Tesla coils. The great importance of his high frequency investigations in advancing wireless communication is well recognized by all scientists. Equally important but less generally known to the public are his early contributions in advancing the use of electric power.

He conceived the practical induction motor, the first effective method for utilizing alternating current for converting electrical energy into mechanical energy. His many inventions of new forms of dynamos, transformers and other electrical devices were largely instrumental in the adoption of alternating current for the transmission of electric power.

Tesla's enthusiasm has always been an inspiration to all who were fortunate enough to have known him.

## SERVICING NOTES

(Continued from page 309)

### ZENITH CHASSIS, MODEL 5714

When this set chirps on medium to loud signals it is usually caused by a leaky .002

## ATTENTION SERVICEMEN!

Do you have any Servicing Notes available which you would like to bring to the attention of the readers of *Radio-Craft*? If so, send them along and if they are published earn a one year's subscription to *Radio-Craft* for each one submitted.

mfd. condenser connected across the speaker leads. Install another condenser of .002 mfd., 600 volt unit.

MR. ARNOLD LIEN,  
McVie, N. D.

### ZENITH MODEL 85432 (1940)

Intermittent oscillation and howl is often caused by a loose I.F. tube shield. This shield may seem well grounded, there being a small piece of adhesive tape holding it in place. The remedy is to bend the bottom of the shield so as to make a better ground.

JOSEPH S. NAPORA,  
Uniontown, Penna.

### ZENITH MODEL 52

When this set is afflicted with a loud R.F. gurgle hum, check the radio frequency choke in the first R.F. grid return circuit. It will be found open. The break, however, usually occurs near the outside end and can be repaired by unwinding a few turns and resoldering.

ROBERT E. ALTOMARE,  
Washington, D. C.

# SPECIAL

### ABC OF TELEVISION



Contains latest material on Television developments. It covers theory of scanning, simple television receiver, how the eye sees, neon lamps, electric coil; neon lamps; need for broad channel width in transmission signals; cathode ray tube and television receivers; Farnsworth transmission, and other important features.

### SHORT WAVE GUIDE

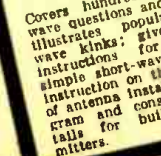

Covers hundreds of short-wave questions and answers; illustrates popular short-wave links; gives explicit instructions for building simple short-wave receiver; instruction on the best type of antenna installation; diagram and construction details for building transmitters.

The books listed below have never been sold by us before. The value of each book is 50c. They are exactly the same as RADIO & TELEVISION'S 50c blue books which have been on the market for years.

For a short time only we are selling these at a special reduced price of only 75c for the 3 books.

All of the books contain numerous photographic illustrations and diagrams and have stiff flexible cover.

### S. W. RADIO QUIZ BOOK

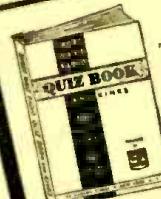

This book covers questions and answers on transmitters, short-wave receivers, ultra short-wave receivers; practical kinks, wrinkles and technical data; novel coil winding; convert-hook-ups for experimenters; how to "hook-up" converters, noise silencers, beat suppressors, antennas, pre-oscillators, 5-meter receivers, selectors.

**RADIO & TELEVISION**  
25 W. Broadway,  
New York, N. Y.

Gentlemen:  
Enclosed you will find remittance for 75c (cash, now U. S. stamps or money order accepted) for which please send me at once your 3 books  
**ABC OF TELEVISION** **SHORT WAVE GUIDE**  
**SHORT WAVE RADIO QUIZ BOOK**  
PLEASE PRINT CLEARLY

Name .....

Address .....

City ..... State ..... RC-2-43

# EXPERIMENTS WITH A FORD SPARK COIL

By HAROLD HELD

**A** USED Ford coil can be obtained for a few cents at many garages and junk shops, or purchased new at auto supply stores for 75 cents to a dollar. A Ford spark coil is an induction coil

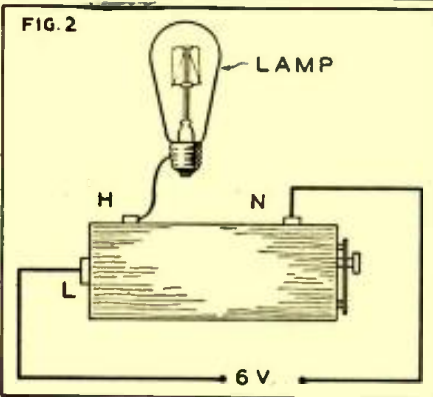
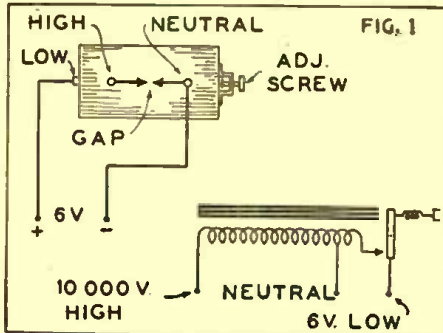

which steps up 6 volts to about 10,000 volts. The input can be either A.C. or D.C.

The coil has three terminals (Fig. 1),— low-voltage input, high-voltage output, and neutral. The neutral terminal will not shock the operator, although it is the common lead to both the low and high voltages. In any event, always proceed with caution in your experiments.

The first thing to do is to solder on terminals, if they are missing. Connect the input, with a switch in series, to a 6-volt source (storage battery, or four large 1½-volt cells), or to 5 to 7 volts of A.C. from a toy transformer, or to a 5 to 6.3 volt filament supply.

Place short leads in the high voltage and neutral terminals, separating the free ends by a ½-inch space. Throw the switch on, and a buzzing should start at the vibrator, and sparks should jump across the gap. Adjust the screw on the vibrator for the greatest intensity.

The coil can be used in many interesting experiments. The light of the spark is rich in ultra-violet rays. These rays will cause various fluorescent materials (fluoride minerals, oils, etc.) to glow.

Connecting the base of a clear electric light bulb or radio tube to the high voltage (Fig. 2) causes the gas within to glow. Touching the top of the tube causes the bulb to become brighter (Use a gloved hand only).

Radioactivity takes place during this experiment (as shown on page 694 of March 1941 issue of *Radio & Television*)

The coil can also be used as a generator for an Oudin Coil (Page 110, June 1940

issue of *Radio & Television*)

Some of the radio uses of this coil include making out of it a portable power supply (Fig. 3), or an output transformer (Fig. 4).

These are only a few of the many uses of the coil. The reader should be able to find many other practical and experimental uses as far as his ingenuity will permit.

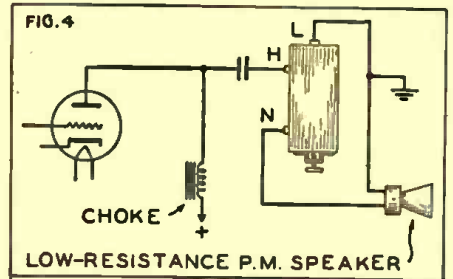
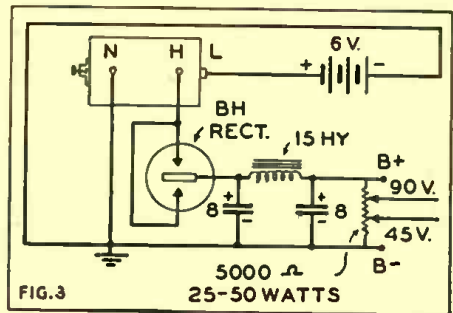

# JUNK BOX OSCILLATOR

By ROBERT DICK

**F**OLLOWING is a diagram and data for constructing a cheap, handy, junk box oscillator, which I have found very useful.

The chassis was made from a 6x14 inch piece of ½-inch masonite, with ½x1½-inch end pieces to support it.

The coil is wound on a 2½-inch diameter form and is center-tapped. Each side is wound with 30 turns of No. 20 D.S.C. wire.

The center tap is brought out to a coil support bracket and the bracket is mounted directly on the light socket.

A 40-watt lamp is used as a filament dropping resistor.

A 37 tube is used as the oscillator but any 6-volt triode may be used.

I use a 3 megohm resistor across a .00025 mfd. condenser as a grid leak, but any value from 1 to 5 megas may be used.

A .000365 mfd. variable condenser is connected across the outside terminals of the coil.

The stator side of the variable condenser and one side of the coil is connected through the grid leak and condenser to the grid of the tube used.

The condenser rotor and the other side

of the coil are connected to the plate through the primary of an audio transformer of any size.

The coil center tap is connected to one side of the lamp socket, also one side of the 110-volt line to the same side.

The other side of the lamp socket goes to one side of the heater and cathode of the 37. The other side goes to the other heater terminal. A switch is used to turn the circuit on and off.

The output is taken from the secondary

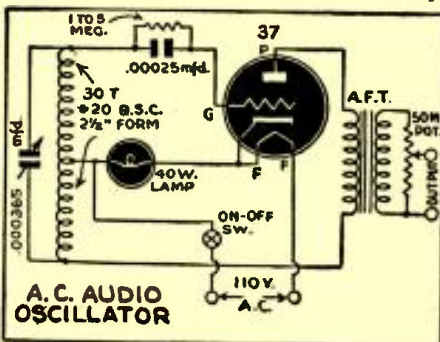

of the audio transformer, through a 50,000 ohm potentiometer in a voltage-divider circuit, to two output jacks.

The potentiometer and the output jacks are mounted on brackets fastened to the baseboard.

The output of the oscillator is modulated by the 60 cycle hum of the light line and is easily recognized.

To calibrate the oscillator, turn on the oscillator and set the tuning condenser on maximum. Tune in a signal on the radio. Read the frequency from the dial and record the setting on the dial of the oscillator.

Do this for each of ten divisions on the oscillator, and then retune the receiver and the oscillator.

### Parts List

#### CONDENSERS

- One .00025 mica
- One .00365 mf. variable

#### RESISTORS

- One to 4 meg, grid leak
- One 50,000 ohm potentiometer

#### MISCELLANEOUS

- One oscillator coil made of 60 turns of No. 20 D.S.C. wire tapped at the 30th turn, wound on a 2½ inch form

(Continued on page 312)

**RADIO AMATEUR COURSE**

**RADIO & TELEVISION**

By **G.W. Shuart**  
**W2AMN**

PRICE 50¢

**148 PAGES**  
6 x 9 INCHES

**OVER 150 RADIO DIAGRAMS**  
and **TECHNICAL PHOTOGRAPHS**

**RADIO AND TELEVISION**  
25 West Broadway New York, N. Y.

**Your Money Back —**  
**If the RADIO AMATEUR COURSE does not represent the greatest book value ever offered to the radio "fans" for . . . . . 50c**

**T**O convince you that there isn't a better book buy today, the publishers of the **RADIO AMATEUR COURSE** make the sensational offer of a money-back guarantee on such a low-priced book. Stop in at any of the many dealers handling this book and examine it. See for yourself if the **RADIO AMATEUR COURSE** isn't just the book you've always wanted.

Printed on the finest coated paper—well illustrated attractive 4-color cover—complete with radio information you must have. It contains a step-by-step program for obtaining a short-wave radio education.

Written by **George W. Shuart, W2AMN**  
foremost short-wave authority

**RADIO AND TELEVISION**  
25 West Broadway, New York, N. Y.

Gentlemen: I enclose herewith my remittance of Fifty Cents (50c) for which please send me **POST-PAID**, my copy of the **RADIO AMATEUR COURSE**. (Remit by check or money order; register letter if you send cash or unused U. S. Postage stamps.)  
**PLEASE PRINT CLEARLY**

Name .....

Address .....

City ..... State ..... RC-2-43

be adjusted to feed the 1,000 kc. signal to the receiver, and the receiver oscillator tracking should be checked at this point. If it is off at this frequency it may be necessary to re-align at 1400 and 600 kc. to make the 1,000 kc. point check closely.

Otherwise it may be assumed that the oscillator frequency tracks above the signal frequency by an amount equal to the I.F. of the receiver, (or within a few kc. of it), over the entire dial. Only in rare cases need the plates of the oscillator tuning condenser be bent to produce this condition.

**ALIGNING THE R.F. STAGES**

Usually directions for alignment specify that the R.F. circuits, consisting of the R.F. amplifier (pre-selector) and the mixer tuning condensers be aligned last—after the oscillator tracking has been checked. However, for speed and directness of work it is best to align them with each other at the same time that the oscillator circuit is being adjusted.

The trimmers on the R.F. condensers may be adjusted for the high-frequency end of the dial at the same time that the oscillator high-frequency tracking trimmer (padder condenser) is being adjusted.

When the signal generator is set to 1400 kc. the trimmers on those sections of the gang tuning condensers which tune these R.F. circuits should be adjusted for maximum output.

The tuning dial should be rocked back and forth slightly about the 1400 kc. point while the adjustments are being made. If the plates of these condenser sections have been bent they should be readjusted over the entire range of the broadcast band. This completes all the high-frequency adjustments to be made on the receiver.

**ALL WAVE, SHORT WAVE AND DUAL BAND RECEIVERS**

The general procedure is about the same as that already described, except that *adjustment must be made for each one of the R.F. bands covered by the receiver.*

There are a few definite frequencies at which the various tuned circuits of all-wave receivers are aligned, viz.: 600, 1400, 1500 and 4800 kc., and the intermediate frequency of employed in the receiver.

The 600 and the 1400 kc. points are for the standard band. The 4800 kc. point is for the first short-wave band. The 15,000 kc. point is for the second short-wave band. There may, or may not be, a line-up point for the final band. The exact line-up frequencies for a particular receiver must be obtained from the manufacturer's data as few receivers cover precisely the same frequency band for each position of the wave-band switch.

Of course the signal generator should be able to cover all bands with sufficient output. It may be desirable in some cases, also, to measure the image response on the higher frequencies.

*(This article was prepared from data contained in the Radio Troubleshooter's Hand book, by Alfred A. Ghirardi)*

**JUNK BOX OSCILLATOR**

*(Continued from page 311)*

- One 110 V., 30 W. light socket
- One 5 hole socket
- One S.P.S.T. on-off switch
- One Audio transformer (any size)
- Two output jacks
- One 6 x 14 x 3/4 inch masonite baseboard on 1/2 x 6 x 1 1/2 inch supports
- One 40 W., 110 V. lamp
- One 37 or similar triode tube.

**"THE INDUCTANCE AUTHORITY"**

By **EDWARD M. SHIEPE, B.S., M.E.E.**  
(A NEW BOOK)

**T**HE ONLY BOOK OF ITS KIND IN THE WORLD, "The Inductance Authority" entirely dispenses with any and all computation for the construction of solenoid coils for tuning with variable or fixed condensers of any capacity, covering from ultra frequencies to the borderline of audio frequencies. All one has to do is to read the charts. Accuracy to 1 per cent may be attained. It is the first time that any system dispensing with calculations and correction factors has been presented.

There are thirty-eight charts, of which thirty-six cover the numbers of turns and inductive results for the various wire sizes used in commercial practice (Nos. 14 to 32), as well as the different types of covering (single silk, cotton-double silk, double cotton and enamel) and diameters of 3/4, 7/8, 1, 1 1/4, 1 1/2, 1 3/4, 1 7/8, 2, 2 1/4, 2 1/2, 2 3/4 and 3 inches.

Each turns chart for a given wire has a separate curve for each of the thirteen form diameters.

The book contains all the necessary information to give the final word on coil construction to service men engaged in replacement work, home experimenters, short-wave enthusiasts, amateurs, engineers, teachers, students, etc.

There are ten pages of textual discussion by Mr. Shiepe, graduate of the Massachusetts Institute of Technology and of the Polytechnic Institute of Brooklyn, in which the considerations for accuracy in attaining inductive values are set forth.

The book has a flexible fiber black cover, the page size is 9 x 12 inches and the legibility of all curves (black lines on white field) is excellent.

Price at your dealer or direct—\$2.50

**GOLD SHIELD PRODUCTS**

350 Greenwich St., (Dept R.C.2), New York City

**ALIGNING SUPERHETS**

*(Continued from page 282)*

time, till the signal comes in at maximum when the dial is set at 1400.

Go over the oscillator and R.F. trimmers once more, to obtain the highest output indicator deflection.

If a low-frequency tracking padder is provided on the receiver oscillator, adjust it, with both the signal generator and the receiver set to 600 kc. Adjust until greatest output indication is obtained. Make this adjustment while the receiver dial is rocked slightly about its 600 kc. position. (The R.F. circuit tuning condensers are not provided with low-frequency padders but their split rotor plates can be bent carefully so as to make output indication maximum).

Re-check the high-frequency oscillator tracking adjustment at this point, for accurate results.

In the case of midget receivers a low-frequency oscillator-tracking padder is not provided. In such cases the tuning dial must be turned about the shaft (after loosening the set-screws) so that the broadcast signals at the low-frequency end of the tuning range can be received at the correct receiver dial settings.

The high-frequency oscillator tracking trimmer is then adjusted so that when a 1400 kc. signal is received it produces maximum output when the receiver tuning dial is very close to the 1400 kc. point.

Although no adjustment for correct tracking between R.F. and oscillator circuits is made between 1400 and 600 kc., some recent circuit automatically track exactly at 1,000 kc., (because of design of padding circuits), if the tracking is correct at 600 and 1400 kc.

In such cases the signal generator should

**KEY FROM PHONE JACK**

The springs in the average phone jack make a very good substitute key, and one can be made very nicely, following the suggestions shown in the illustration. The

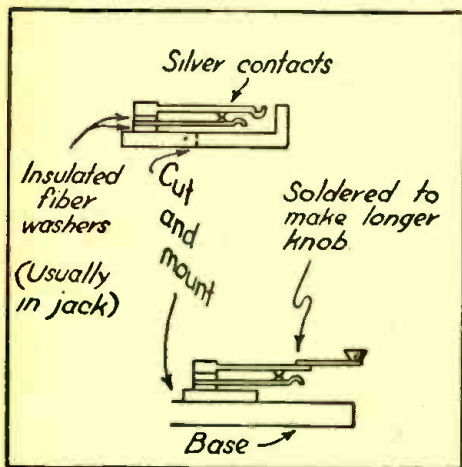

silver points on the contact springs of the jack serve to open and close the circuit, and all you have to do is to add another strip of brass (with a button fitted on the outer end) to manipulate the improvised key.—*Joe Binko.*

**LEG OPERATING BENCH FOR PORTABLE-MOBILE WORK**

The operator in the field often has real need of some type of operating bench for mike, key and log-hook. The "leg-bench" shown in the illustration has been designed to afford just such opportunities. It serves the purpose well, yet can be easily carried along in a small space and adjusted immediately for use when necessary.

Provide a smoothed board about 16 to 18 inches long and 6 or more inches wide. Mount the key near the right end where it will come over the right leg. Toward the left arrange a pair of springs as detailed, into which the handle of the mike can be clipped.

In the center arrange two little spring clips to hold down the pages of the log or

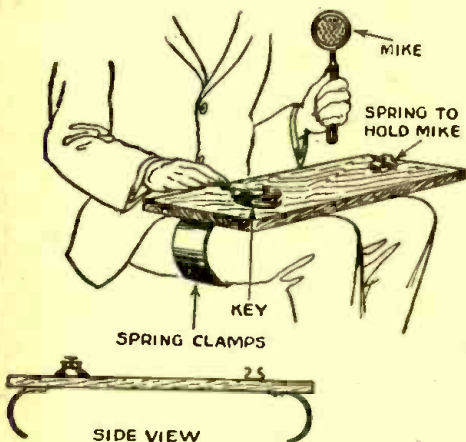

message paper against winds, etc. Under each end of the board fasten two semi-circular pieces of spring metal that will clamp under the legs as shown.

With this bench in position the operator can operate the key nicely, copy the message and use the mike when called for; all on one bench and within easy reach.

L. B. ROBBINS,  
Harwich, Conn.

**CHEAP MIKE STAND**

A money-saving idea for the amateur or serviceman is to start with a stand such as is used by department stores to hang advertising cards from, and convert it into an attractive microphone stand.

These stands are chrome plated and have an appearance suitable for the best club or hotel P. A. system. Many department stores will sell them for a little over a dollar. They may also be purchased at an advertising supply house.

To convert the stand, unscrew the cross bar on top, which has clips fastened to it for



holding price cards. Most mikes can then be screwed on the rod, but with other types a reducing connector will have to be used to make up for the difference in size of the rod and the mike.

DAVE SCHICK,  
Seattle, Washington.

**VIBRATOR SUPPLY**

Following is a kink that I have found very handy as well as money-saving. It involves the use of the 6-volt and 5-volt windings of an ordinary power transformer as the primaries of a vibrator transformer in a 6-volt power supply.

Although some may shudder at the

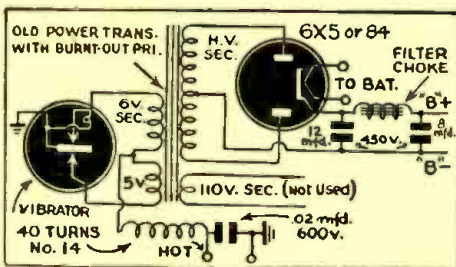

thought of using an unbalanced primary like this, a good hash suppression system such as the one in the diagram, together with a good filter will iron out the hum, etc., introduced by the fluctuating voltages.

As it is a simple matter to pick up an old, supposedly no-good vibrator, and make it work, it is possible, with the aid of this kink, to build a first rate vibrator supply for practically nothing.

PAUL GREEN,  
Chapel Hill, N. C.

**MIKE STAND FROM A BAMBOO FISH POLE**

Here is a nice mike stand that can be made by any handy man from a short length of bamboo fish pole and a barrel (Continued on page 314)

**GEOPHYSICAL PROSPECTING PRINTS TREASURE FINDERS**

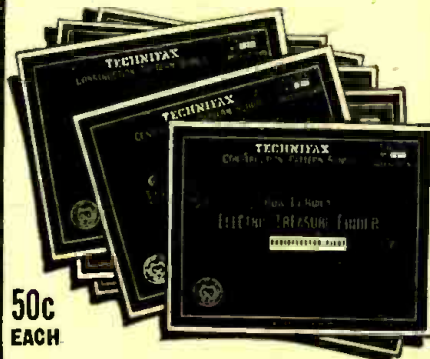

50c EACH

**BLUEPRINTS and INSTRUCTIONS**

For Building the Following Treasure Finders and Prospecting Outfits

Folder No. 1. The "Radiosector Pilot"—consists of a 2-tube transmitter and 3-tube receiver. Principle: radiated Wave from transmitter loop is reflected back to receiver loop. Emits visual and aural signals.

Folder No. 2. The "Harmonic Frequency Locator"—Transmitter radiates low frequency wave to receiver, tuned to one of Harmonics of transmitter. Using regenerative circuit. Emits aural signals.

Folder No. 3. The "Beat-Note Indicator"—Two oscillators so adjusted as to produce beat-note. Emits visual and aural signals.

Folder No. 4. The "Radio-Balance Surveyor"—a modulated transmitter and very sensitive loop receiver. Principle: Balanced loop. Emits visual and aural signals. By triangulation depth of objects in ground can be established.

Folder No. 5. The "Variable Inductance Monitor"—a single tube oscillator generating fixed modulated signals and receiver employing two stages R.F. amplification. Works on the inductance principle. Emits aural signals.

Folder No. 6. The "Hughes Inductance-Balance Explorer"—a single tube Hartley oscillator transmitter and sensitive 3-tube receiver. Principle: Wheatstone bridge. Emits aural signals.

Folder No. 7. The "Radiodyne Prospector"—a completely shielded instrument. Principle: Balanced loop. Transmitter, receiver and batteries enclosed in steel box. Very large field of radiation and depth of penetration. Emits aural signals.

With any one of the modern geophysical methods described in the Blue-Print patterns, radio outfits and instruments can be constructed to locate metal and ore deposits (prospecting); finding lost or buried treasures; metal war relics; sea and land mines and "duds"; mineral deposits; subterranean water veins; oil deposits (under certain circumstances); buried gas and water pipes; tools or other metallic objects sunken in water, etc., etc.

Each set of blueprints and instructions enclosed in heavy envelope (9 1/2" x 12 1/2"). Blueprints 22" x 34"; eight-page illustrated 8 1/2" x 11" folder of instructions and construction data. **50c**

The complete set of seven folders ..... **\$3.00**  
Shipping weight 2 lbs. (add 25c for shipping anywhere in U.S.A.)

**TECHNIFAX**

RC-243

1917 S. STATE ST. CHICAGO, ILL.

**TECHNIFAX** 1917 So. State, Chicago, Ill.

Enclosed herewith \$..... for which mail to address below:

Treasure FINDER No. 1, 2, 3, 4, 5, 6, 7.  
Complete set of seven folders.

NAME .....

ADDRESS .....

CITY ..... STATE .....

RC-243

**LEARN! . . .**

**CODE**  
By copying code with an

*Echophone*

**COMMUNICATIONS  
RECEIVER**



MODEL EC-2

Here's the new and improved version of this popular set. Now with an external speaker (just like EC-3). Automatic noise limiter, preselection on all bands, calibrated bandspread, AC-DC safety headphone jack, 8 tubes, \$50 Kc to 30.5 Mc. Bigger value than ever at only \$42.50, complete with speaker in matching cabinet.

Mail in your order today!

**HARRISON**

RADIO CORPORATION

11 WEST BROADWAY

NEW YORK CITY

**THEORY**

From These Radio Books, For The BEGINNER to the ENGINEER

|  |        |
|--|--------|
| FUNDAMENTALS OF RADIO<br><small>Essex, Simey, etc.</small>                 | \$5.00 |
| RADIO OPERATING QUESTIONS & ANSWERS<br><small>Nilson &amp; Hornung</small> | 2.50   |
| PRACTICAL RADIO COMMUNICATION<br><small>Nilson &amp; Hornung</small>       | 5.00   |
| RADIO CODE MANUAL<br><small>Nilson</small>                                 | 2.00   |
| RADIO ENGINEERING HANDBOOK<br><small>Keith Henny</small>                   | 5.00   |
| RADIO ENGINEERING<br><small>F. E. Yermah</small>                           | 5.50   |
| RADIO PHYSICS COURSE<br><small>Ghirardi</small>                            | 5.00   |
| MODERN RADIO SERVICING<br><small>Ghirardi</small>                          | 5.00   |
| A.C. CALCULATION CHARTS<br><small>Lorenzon</small>                         | 7.50   |
| VACUUM TUBE VOLTMETERS<br><small>Rider</small>                             | 2.00   |
| THE CATHODE-RAY TUBE AT WORK<br><small>Rider</small>                       | 3.00   |
| UNDERSTANDING RADIO<br><small>Watson, Welch, Eby</small>                   | 2.80   |
| INDUCTANCE AUTHORITY<br><small>Edward M. Shiepe</small>                    | 2.50   |

**RADIO KINKS**  
(Continued on page 313)

hoop. It is light, will stand firm and costs but little. It will accommodate any type of mike with a vertical bottom shank.

Carefully make two saw cuts up about a third of its length (at the butt end)

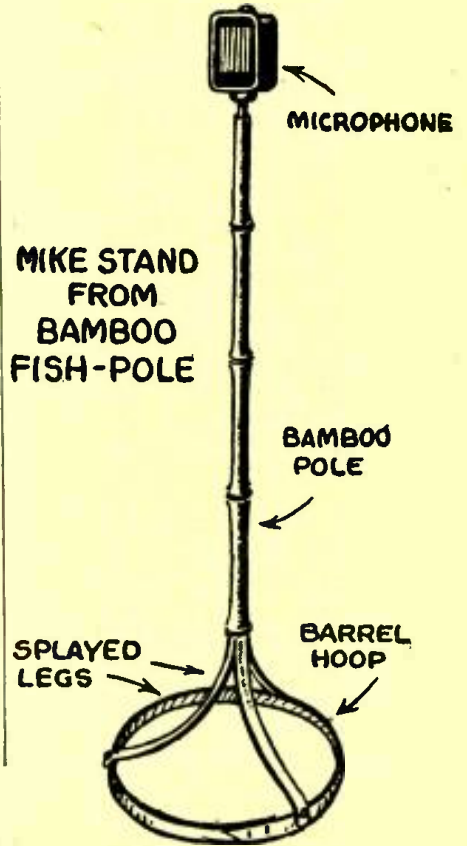

**LAWRENCE SLIDE RULES**

With A, B, C, D, CI and K Scales

**FEATURES:** Nickel Silver Framed Indicator with integral friction springs. Scales calibrated directly on well seasoned wood. Will retain accuracy regardless of temperature or humidity changes.

Instructions and illustrations clearly printed on back of rule for ready reference or teaching. Each rule in a durable pocket carrying case for convenience and protection.

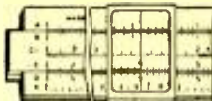

The extremely low price of these slide rules and their absolute accuracy makes them ideal for the student as well as the working man who has always wanted to learn to use a slide rule.

LAWRENCE 10 inch white-enamelled slide rule with flat magnifier. In black case. Price, including 28-page instruction book . . . . . No. 457. . . . . 60c  
Secret Code Slide Rule, with 20-page book No. 458. . . . . 30c  
28-page illustrated book of instructions, postpaid No. 459. . . . . 15c

**GOLD SHIELD PRODUCTS**

350 Greenwich St. (Dept. RC2) New York City

**Inventions Wanted**  
Patented or Unpatented

We have been successfully selling inventions, patented and unpatented, since 1924. Write us, if you have a practical, useful idea for sale.

**CHARTERED INSTITUTE OF AMERICAN INVENTORS**

Dept. 108 Barrister Building, Washington, D.C.

**PATENTS — TRADE MARKS**

Booklet concerning Inventions & Patents Form "Evidence of Conception" with instructions for use and "Schedule of Government and Attorneys Fees"—Free  
**LANCASTER, ALLWINE & ROMMEL**  
Registered Patent Attorneys  
486 Bowen Bldg. Washington, D. C.

**SEPARATE LOOP FOR ALIGNING WORK**

Many of the newer sets using built-in antennas require the use of a loop to line up the set instead of using direct connection to the oscillator. We have installed a loop of a few turns of wire which is fastened under the work bench. The leads of this loop are brought out to binding posts so that the oscillator can be connected to it. When lining up a set the set is placed in the field of this coil and adjustments made.

—Gilbert Sharick, Princeton, Ill.  
—From C-D Capacitor.

**TESTING FOR SHORTED BYPASS CAPACITORS**

In order to save time and work unsoldering capacitors, a shorted capacitor can be easily determined by using an ohmmeter range that is less than the resistance of the shunt. A 0-10 ohm range will show infinite resistance for good capacitors and zero resistance for shorted capacitors because the shunt resistors have a resistance of more than 10 ohms d.c.—R. M. Hughes, Claymont, Del.

—From C-D Capacitor.

**SERVICE INSPECTION MIRROR**

Service suggestions recommend the use of a dental mirror as visual aid for this work, but dental mirrors are made with the small mirror fixed to the handle at one angle.

The writer, however, obtained a dental mirror at a local drug store which has its small mirror hinged to the handle which permits inspection at any desired angle. Any standard dental mirror can easily be remodeled this way by removing the mirror from the handle and attaching a home made hinge arrangement.—James R. Limbeck, Glendale, Calif.—"The C-D Capacitor."

making one cut at right angles to the other. Soak this portion in boiling water a few moments and then splay the four tines outward as indicated. The base consists of a nice smooth wooden barrel hoop of suitable size. Fasten the end of each tine to the hoop with a small bolt, again soaking the ends of the tines in hot water so they can be bent down in line with the vertical sides of the hoop.

The mike shank can then be forced down into the top of the pole where it can be shimmed to fit or the hole enlarged as may be necessary to hold the mike firm.

L. B. ROBBINS,  
Harwich, Mass.

**SCRATCH FILTER**

Submitted herewith is a circuit diagram for a scratch filter and volume control for

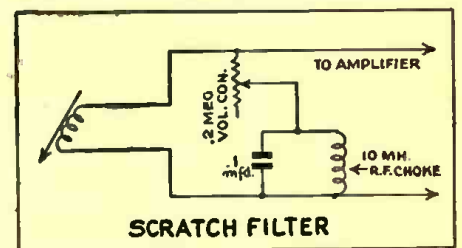

use with any high impedance radio phonograph pick-up. It eliminates scratch noise usually present at approximately 5,000 cycles.

NOLIN QUILLET,  
Cochrane, Canada



**A VERSATILE SQUARE WAVE AND PULSE GENERATOR—Cont.**

(Continued from page 272)

the leading edge and the falling edge), are steep. To determine their exact shape, a frequency which is a multiple of the fundamental frequency is used for sweeping. For a fundamental of 400 cycles for example, use a frequency of say 800 or 1200 cycles. This will spread the pulse on the oscilloscope and then the leading edge or the falling edge can readily be seen. Such observations should be routine, for in some investigations it is important to know the value of the leading edge.

**USES OF PULSES**

The pulse thus generated can be used for modulating a transmitter, and relay circuits in receivers operated. The operation of these relays can be controlled by the pulse, very accurately. Exact applications cannot be given, since they are beyond the scope of the article; nor can inquiries and questions on the exact use of pulses be furnished or given in answers to letters. The experimenter will have to do his own research in this respect.

Questions regarding the generator itself, however, will be gladly answered and any form of help in the construction details will be readily tendered.

**Parts List**

**RESISTORS**

- R1 .25 Megohm Variable Control, Centralab
- R2 800 Ohm, BT 1/2, I.R.C.
- R3 5000 Ohm, BT 1/2, I.R.C.
- R4 100,000 Ohm Variable control, Centralab
- R5 100,000 Ohm, BT 1, I.R.C.
- R6 2 Megohm, variable control, Centralab
- R7 20,000 Ohm, BT 1, I.R.C.
- R8 10-20 Megohm, BT 1/2 (not critical between values indicated), I.R.C.
- R9 10,000 Ohm, BT 1/2, I.R.C.
- R10 8,000 Ohm, BT 2, I.R.C.
- R11 2,000 Ohm, 20 Watt, Variable control, Ohmite
- R12 1,000 Ohm, 25 Watt, fixed, wire-wound, Ohmite
- R13 1,000 Ohm, 25 Watt, fixed, wire-wound, Ohmite
- R14 100,000 Ohm, BT 1/2 Watt
- R15 50,000 Ohm, BT 1/2 Watt
- R16 10-20 Megohm, BT 1/2 Watt

**CONDENSERS**

- C1 1 Mfd. 600 Volt, Paper, Cornell-Dubilier
- C2 1 Mfd. 600 Volt, Paper, Cornell-Dubilier
- C3 .05 Mfd. 600 Volt, Paper, Cornell-Dubilier
- C4 .01 Mfd. 600 Volt, Paper, Cornell-Dubilier
- C5 .005 Mfd. 600 Volt, Paper, Cornell-Dubilier
- C6 .0005 Mfd. 600 Volt, Mica, Cornell-Dubilier
- C7 .05 Mfd. 600 Volt, Paper, Cornell-Dubilier
- C8 .25 Mfd. 600 Volt, Paper, Cornell-Dubilier
- C9 1 Mfd. 600 Volt, Paper, Cornell-Dubilier
- C10 1 Mfd. 600 Volt, Paper, Cornell-Dubilier
- C11 1 Mfd. 600 Volt, Paper, Cornell-Dubilier
- C12 .006 Mfd. 600 Volt, Paper, Cornell-Dubilier
- C13 .30 Mfd., electrolytic, 450-volt, Cornell-Dubilier
- C14 20 Mfd., electrolytic, 450-volt, Cornell-Dubilier
- C15 10 Mfd., electrolytic, 450-volt, Cornell-Dubilier
- C16 Value depends on requirements. See text for explanation.

F #1075 Holder and 1-ampere fuse, Littelfuse

B1 Binding post, dual type, Millen

B2 Binding post, dual type, Millen

T1 Power transformer, 110-120 volt, 60-cycle primary. Secondary 350-0-350 volt RMS, 5-volt, 2-amp.; 6.3-volt, 3-amp.

C Cabinet 10" x 10" x 8"

C Chassis to fit cabinet

1 Line cord and plug

1 6SC7 or similar tube

1 7C7 or similar tube

1 7C5 or similar tube

1 5Y3 or similar tube

SW1 On-off switch

SW2 Single-pole, 6-position switch, Autralab

5 Knobs

2 Tube shields, loctal type

4 Dial plates, Crowe or Gordon

*Lowest Priced Publications for Experimenters*

**10 FOR 50c**

Here is a large number of radio, short-wave, and mechanical "how-to-make-it" designs. Each is a special publication originated by masters in their respective fields. For the low price of 50 CENTS, you buy TEN complete pamphlets with photographic reproductions, complete mechanical layout, and full description to make it possible for anyone to build the project in question.

PLEASE ORDER EACH PROJECT BY ITS PUBLICATION NUMBER, and use the special coupon below. We accept money-orders, cash, checks or new U. S. stamps. (No foreign stamps.) If you send cash or stamps, register your letter. Money refunded if you are not satisfied. ANY TWENTY-FOUR PUBLICATIONS FOR ONE DOLLAR.

**SHORT-WAVE RECEIVER PUBLICATIONS**

- HOW TO MAKE THE "OSCILLODYNE" 1-TUBE WONDER SET. No. 101
- HOW TO MAKE THE "19" TWINPLEX (ONE TUBE PERFORMS AS TWO) RECEIVER. No. 102
- HOW TO MAKE THE WIZARD 1-TUBE 50-WATT TRANSMITTER. No. 103
- HOW TO MAKE THE IMPROVED 3-TUBE DOERLE SET FOR BATTERY OPERATION. No. 104
- HOW TO MAKE THE "GO-GET-EM 2" RECEIVER FOR THE BEGINNER. No. 105

- HOW TO MAKE THE 1-TUBE ALL-ELECTRIC OSCILLODYNE. No. 106
- HOW TO MAKE THE 2 TO 5 METER TWO-TUBE LOUDSPEAKER SET. No. 107
- HOW TO MAKE THE 3-TUBE BATTERY SHORT-WAVE RECEIVER. No. 108
- THE BRIEF-CASE SHORT-WAVE RECEIVER AND HOW TO BUILD IT. No. 109
- HOW TO BUILD THE POCKET SHORT-WAVE RECEIVER. No. 110
- HOW TO BUILD THE CIGAR-BOX 1-TUBE "CATCH ALL" RECEIVER. No. 111

- HOW TO BUILD THE "DUAL-WAVE" SHORT-WAVE BATTERY RECEIVER. No. 112
- HOW TO BUILD THE 1-TUBE "53" TWINPLEX" RECEIVER. No. 113
- HOW TO BUILD THE PORTABLE MINIDYNE SHORT-WAVE BATTERY SET. No. 114
- HOW TO BUILD THE HAM-BAND "PEE-WEE" 2-TUBER. No. 115
- HOW TO BUILD THE DUO-AMPLIDYNE. No. 116
- HOW TO BUILD THE "MONO-COIL 2." No. 117

**RADIO BROADCAST RECEIVER AND SPECIAL RADIO PUBLICATIONS**

- HOW TO MAKE THE A.C.-D.C. "CASH BOX" RECEIVER No. 118
- HOW TO MAKE BEGINNER'S 2-TUBE ALL-WAVE SET. No. 119
- HOW TO BUILD THE "RADIO-LAMP" 4-TUBE TABLE RECEIVER. No. 120
- HOW TO BUILD A SUPER-SENSITIVE ALL-WAVE CRYSTAL SET. No. 121

- HOW TO BUILD THE 2-TUBE "PENTODE PORTABLE" BROADCAST SET. No. 122
- HOW TO BUILD THE RADIO "TREASURE" FINDER. No. 123
- HOW TO BUILD THE GERNSBACK ONE-TUBE PENTODE LOUDSPEAKER SET. No. 124
- HOW TO BUILD THE WORLD'S SMALLEST ONE TUBE BATTERY RADIO. No. 125

- HOW TO BUILD A 6-TUBE BATTERY ALL-WAVE "FARM PORTABLE" SET. No. 128
- HOW TO MAKE AN A.C.-D.C. ONE-TUBE "DEAF AID." No. 127
- HOW TO BUILD A PIANOTRON. No. 128
- HOW TO BUILD THE ONE-DOLLAR RADIO. No. 129
- HOW TO MAKE A VARIABLE-TONE CODE PRACTICE SET. No. 130

**MECHANICAL PROJECTS PUBLICATIONS**

- HOW TO MAKE A SOUTH SEA OUTRIGGER CANOE. No. 131
- HOW TO BUILD A PEE-WEE AUTOMOBILE. No. 132
- HOW TO BUILD A DUAL-CONTROL GLIDER. No. 133
- HOW TO BUILD A HOUSEBOAT ON PONTONS. No. 134
- HOW TO MAKE A BAND SAW FROM OLD AUTO PARTS. No. 135
- HOW TO BUILD A REAL LATHE FOR \$5.00. No. 136
- HOW TO BUILD A SAIL CAT-BOAT. No. 137

- HOW TO BUILD A SIMPLE PORTABLE REFRIGERATOR. No. 138
- HOW TO BUILD A XYLOPHONE. No. 139
- HOW TO BUILD THE ROWMOBILE. No. 140
- HOW TO BUILD LARGE TESLA AND OUDIN COILS GIVING 18-INCH SPARKS. No. 141
- HOW TO MAKE AN ARC WELDER. No. 142
- HOW TO USE AN A.C. ARC WELDER. No. 143

- HOW TO MAKE YOUR OWN MICROSCOPE. No. 144
- HOW TO MAKE A WIMSHURST ELECTROSTATIC MACHINE. No. 145
- HOW TO MAKE A POWER DRILL PRESS FROM SCRAP PARTS. No. 146
- HOW TO BUILD A GOOD LATHE FOR \$1.00. No. 147
- HOW TO MAKE AND EXPERIMENT WITH AN ELECTROPHOROUS. No. 148
- HOW TO MAKE AN ELECTRIC ARC WELDER FROM AN AUTOMOBILE GENERATOR. No. 149

**RADIO PUBLICATIONS, 25 West Broadway, NEW YORK, N. Y. RC 2**

|   |     |     |     |     |     |     |
|---|-----|-----|-----|-----|-----|-----|
| I enclose \$.....for the publications listed by number, at right, at the rate of 50c FOR ANY TEN PUBLICATIONS. NO ORDER FOR LESS THAN 50c ACCEPTED. \$1.00 for 24 publications. These publications are to be sent to me Postpaid. I have placed a circle around each number which I want. | 101 | 102 | 103 | 104 | 105 | 106 |
| PLEASE PRINT CLEARLY  | 107 | 108 | 109 | 110 | 111 | 112 |
| Name .....  | 113 | 114 | 115 | 116 | 117 | 118 |
| Address .....   | 119 | 120 | 121 | 122 | 123 | 124 |
| City .....  | 125 | 126 | 127 | 128 | 129 | 130 |
| State .....   | 131 | 132 | 133 | 134 | 135 | 136 |
| .....   | 137 | 138 | 139 | 140 | 141 | 142 |
| .....   | 143 | 144 | 145 | 146 | 147 | 148 |
| .....   |     |     |     |     | 149 |     |

**10 BEST RADIO BOOKS 10 CENTS EACH**

- RADIO FANS EVERYWHERE—these fine ten cent text books give you an excellent foundation for the study of RADIO. They are clearly written, profusely illustrated and contain over 15,000 words in each book. You'll be
- No. 1—HOW TO BUILD FOUR DOERLE SHORT WAVE SETS
- No. 2—HOW TO MAKE THE MOST POPULAR ALL-WAVE 1- AND 2-TUBE RECEIVERS
- No. 3—ALTERNATING CURRENT FOR BEGINNERS
- No. 4—ALL ABOUT AERIALS

- amazed at the wealth of information contained in these handy books. Excellent for reference—ideal for every technical library. YOUR MONEY BACK if you are not satisfied. PROMPT SHIPMENTS
- No. 5—BEGINNERS' RADIO DICTIONARY
- No. 6—HOW TO HAVE FUN WITH RADIO
- No. 7—HOW TO READ RADIO DIAGRAMS
- No. 8—RADIO FOR BEGINNERS
- No. 9—SIMPLE ELECTRICAL EXPERIMENTS
- No. 10—TELEVISION

**BOOKS ARE ALL UNIFORM**

Every book in the GERNSBACK EDUCATIONAL LIBRARY has 32 pages—with illustrations varying from 30 to 68 in number. Each title volume contains over 15,000 words. Positively radio's greatest book buys! If you do not think these books worth the price asked, return them in 24 hours and your money will be instantly refunded.

**RADIO PUBLICATIONS • 25 WEST BROADWAY • NEW YORK, N. Y.**

RADIO PUBLICATIONS, Dept. RC-243  
25 WEST BROADWAY, NEW YORK, N. Y.

Gentlemen: Please send immediately, POSTPAID, the book numbers circled below, I am enclosing ..... cents —each book being 10c.

1 2 3 4 5 6 7 8 9 10  
NEW NEW

Send FREE listing of 48 new 10c publications.

PLEASE PRINT CLEARLY

Name ..... Address .....

City ..... State .....

Remit by check or money order—register letter if you send cash or unused U. S. postage stamps.

**MAIL COUPON TODAY!**

**MEN AND WOMEN  
AIRCRAFT RADIO COM-  
MUNICATIONS COURSE**

Specialist training for those planning to enter WAVES, WAACS, Army, Navy, Merchant Marine or private industry. Radio telephone, Radio telegraph, Radio Code, complete preparation for FCC license examinations. Learn in Miami!

Write or wire  
**Embry-Riddle School of Aviation**  
3240 N.W. 27TH AVENUE  
MIAMI, FLORIDA

.....MIRROR.....  
**RECORD DISCS—NEEDLES  
AND ALL EQUIPMENT  
FOR INSTANTANEOUS RECORDING**

We specialize in the manufacture and sale of Blank Recording discs for all purposes. Our famous Gold Label DISCS are used extensively by Broadcasting and professional recording studios. Our Semi-Professional "Pronto" Recording DISCS are just what the student and home recording enthusiast needs. BOTH type discs cost about half of other professional types because they use "a tough FIBRE BASE," instead of unobtainable aluminum or fragile glass.

Write for our price sheet  
**MIRROR RECORD CORP.**  
58 WEST 25th ST., N. Y. C.

**LEARN RADIO  
TELEVISION**

600 LICENSED graduates placed in past 7 years in shipping, broadcasting, aviation, police, etc.; we also teach radio servicing and repairing; new beginners' class now forming; 60-page catalog free; oldest, largest and best equipped.

**MASS. RADIO SCHOOL**  
18 BOYLSTON ST., BOSTON, MASS., Est. 1899

LES  
RECORDING  
DISCS

Correspondence Courses in  
**RADIO and ELECTRICAL ENGINEERING**

**ELECTRICAL ENGINEERING** Get good grasp of wide electrical field. Prepare yourself at Low Cost for secure future. Modern, simplified, you can understand quickly.

**RADIO ENGINEERING** Extra fine course in radio, public address, music, etc. Get good job. Photo-electric work. Technician. Exper. kits furnished. Diploma on completion. Tuition \$25. either course. Deferred payment plan.

**FREE** Get copies of school catalogs, student magazines, complete details. SEND NOW!

LINCOLN ENGINEERING SCHOOL Box 931-C48. LINCOLN, NEBR.

**PRE-INDUCTION  
RADIO COURSES**  
FOR CIVILIANS AND THOSE ENTERING  
MILITARY SERVICE

NEW CLASSES NOW STARTING

• RADIO OPERATING • CODE  
• RADIO SERVICING

**New York Y.M.C.A. Schools**  
4 W. 64th Street New York City

Quality above all  
**SOLAR**  
CAPACITORS

**SOLAR CAPACITOR SALES CORP.**  
Bayonne, N. J.

**POPULAR ELECTRONICS**

(Continued from page 268)

Testing for surface faults in shafts, etc., by use of phonograph needle (Amp.)

**TRAFFIC**

Railroad signals (PE, Amp., Osc.)  
Street traffic lights (PE)  
Elevator leveling (PE, Osc.)  
Elevator-door safety control (PE)  
Routing mail-bags and letters (PE)  
Counting street traffic (PE, Amp.)  
Checking up bridge-toll collections (PE, Amp.)  
Checking up theater patronage (PE, Amp.)  
Detecting dangerous gas in tunnels (PE)  
Lighting air-beacons and air-fields (PE)  
Controlling wind indicators from pilot-vanes (PE, Amp.)  
Detecting automobile speeding (PE)  
Parking lights on automobiles lighted at dusk (PE)  
Head-lamps dimmed at approach of another car (PE)  
Head-room alarms for tunnel and bridge approaches (PE)  
Adjoining street signs and displays controlled by traffic lights (PE)  
Swing-bridge pin-lock safety indicator (PE)  
Identifying and recording freight-car numbers (PE)  
Checking auto crank-case oil at service stations (PE)  
Adjusting illumination in vehicular tunnels (PE)  
Calling gas-station attendant when car stops (PE)  
Sextant for locating sun's position obscured by clouds (PE)  
Railway track inspection (Amp., Osc.)  
Aiding docking of vessels (Amp.)  
Analysis of road traffic (PE)  
Announcing loud speakers in bus and train depots (Amp.)  
Calling-systems in stores (Amp.)  
Directing traffic from police cars (Amp.)  
Locating mobile bodies in water, fog, etc. (Amp.)

**GRADING (PE)**

Cigars  
Tile  
Beans, vegetables  
Inspecting tin-plate  
Detecting missing labels  
Calipering small parts  
Adjusting auto headlights  
Detecting flaws in products  
Sorting checks and bills  
Matching false teeth  
Oil and paint  
Sorting resistors (Amp., PE)  
Rejection of non-sharp razor blades

**SCIENTIFIC INSTRUMENTS**

Bridge balance indicator (Amp., PE)  
Camera shutter tests (PE)  
Cosmic-ray counter (Amp.)  
Curve plotter (PE)  
Dilatometer (Osc.)  
Photometry of lamps (PE)  
Magnetic flux meters (PE)  
Follow-up mechanism (PE)  
Wave-form analysis (Cathode ray)  
Impact meter (Grid-glow)  
Micrometers (Osc., Amp., Grid-glow)  
Continuous calipering (Osc.)  
Protection to meters (Amp.)  
Pressure indicator (Amp.)  
Vacuum-tube wattmeters (Amp.)  
Counting electrons (Amp.)  
Medical diagnosis (Heart Amp.)  
Hysteresiograph (Cathode ray)  
Regulating watches and clocks (Amp.)  
Impulse counter (Amp.)  
Frequency control in astronomical observatory (Amp., Osc.)  
Pyrometers, remote (Amp.)  
Blood analysis (PE)  
Criminal detection (Amp.)  
Titration of chemicals, (PE)  
Measuring viscosity (PE)  
Measuring film density (PE)  
Temperature control (PE, Amp.)  
Testing oils (PE)  
Measuring total light flux (PE)  
Indicating wind velocity (PE)  
Color analysis (PE)  
Color matchers (PE)  
Light-intensity meters (PE)  
Exposure meters (PE)  
Turbidity meters (PE)  
Combustion indicator (PE)  
Master-clock control of secondary clocks (PE, Grid-glow)  
Remote indicating meters (Amp., PE)  
Indicating shaft rotation (PE)  
Meridian passage of stars (PE)  
Recording variable stars (PE)

Guiding telescope on star (PE)  
Detecting faint spectral lines (PE)  
Measuring instant of eclipse (PE)  
Measuring width of eclipse path (PE)  
Measuring high-rotational speeds blight-producing tones (PE)  
Sighting guns for automatic firing (PE)  
Spectrum analysis (PE)  
Stroboscope (Grid-glow)

**MEDICAL APPLICATIONS**

"Radio knife" (Osc.)  
Musical anesthetic (Amp.)  
Microphone and speaker in operating rooms (Amp.)  
Artificial fever machines (Osc.)  
Super-stethoscopes for listening to internal organs (Amp.)  
Electric cardiograph (Amp., Cathode ray)  
Measuring and treating deafness (Amp.)  
Blood analysis (PE)  
Diagnosis of broken bones, etc. (X-ray)

**LIGHT MEASUREMENTS AND CONTROL**

Schoolroom lighting (PE)  
Shop and factory lighting (PE)  
Electric signs (PE)  
Automatic flashe: (Grid-glow)  
Automatic headlight dimmer (PE)  
Flood lighting and decorative effects (PE, Rect.)  
Store lighting (PE)  
Office lighting (PE)  
Street-lighting circuits (PE)  
Airports, aviator beacon: (PE)  
Lighthouses, range light:, markers (PE)  
Parking lights on autos, automatically lighted at dusk: (PE)  
Store and window lights, turned on at approach of pass-by or patrolman (PE)  
Riding lights on moored vessels, automatically lighted (PE)  
Photographic printing and enlarging (PE)  
Headlight inspection (PE)

**VISUAL REPRODUCTION**

"Facsimile" transmission of photographs, maps, newspapers, etc. (PE)  
Television transmission (PE)  
Half-tone and line-cut production (PE)  
Three-color plate engraving: (PE)  
Enabling the blind to read ordinary print (PE)  
Automatic curtain: framing moving screen (PE)  
Automatic photographing of sneakthieves, burglars, etc. (PE)

**SOUND PRODUCTION**

Phonograph recording (PE)  
Sound-picture recording: (PE)  
Light-beam transmissic.: (PE)  
Light siren (PE)  
Photo-electric organ (PE)  
Talking wills (Amp., PE)  
"Talking book" for the blind (PE, Amp.)  
Talking "rogue: gallery" (Amp., PE)  
Automatic merchandiser says "thank you" when purchase is made: (PE)

**ELECTRIC POWER SYSTEMS**

Synchronizing power circuits (Thyratrons, Amp.)  
Controlling alternator frequency (Amp.)  
Safeguarding high-tension fuses (PE)  
Bus flash-over protection (PE)  
Reporting circuit-breaker operation (PE)  
Detecting flash-overs on rotary converters (PE)  
Controlling street-lighting circuits (PE)  
Controlling isolated plant operation from pre-drawn chart (PE)  
Telemetering (Amp., Osc.)  
Circuit breakers (Thyratron)  
Automatic voltage control (Amp.)  
Lightning arresters (Amp.)  
Vacuum-tube commutator (Thyratron)  
Frequency indicators (Amp.)  
Rectifiers for street-railway power (Rect.)  
Static discharger in antennae (PE)

**PRINTING AND PUBLISHING**

Speed control on fast presses (Rect.)  
Automatic machine setting of type, from type-written copy (PE)  
Halftones made by photoelectric scanning (PE)  
Control of register on web presses (PE)  
Control of accurate trimming (PE)  
Accurate cut-offs for labels, bags, etc. (PE)  
Counting of sheets and forms in binderies (PE)  
Adjusting density of printing (PE)  
Control of paper thickness and moisture during manufacture (PE)  
Matching the colors of inks and papers (PE)

(Continued on page 317)

**WARTIME RESISTORS**

REALIZING the importance of maintaining and servicing home radio sets, at least one resistor manufacturer (IRC) is making available for service men large stocks of the same dependable resistors the armed forces are using (but in ranges and tolerances not called for on war orders) and are offering the following suggestions to enable service men to obtain the greatest possible use of resistors in these times.

**1/2-, 1-, AND 2-WATT RESISTORS**

The resistors in home and automobile sets are almost invariably of the so-called "Preferred Number" or "RMA" standard resistance values, and are color-coded accordingly.

Jobbers have, in the past, carried in stock the 1/2-, 1-, and 2-Watt resistors only in "nominal" or round figure ranges such as 1,000, 5,000, 10,000 and 25,000 ohms, etc.

Now, however, many jobbers are stocking resistors in RMA ranges. These resistors are being furnished by the factory from stocks originally accumulated for the set makers before the manufacture of home sets was discontinued. They are the same quality previously used in the finest radio sets.

**REPLACEMENTS**

A defective resistor in a set can always be replaced satisfactorily by a new resistor within 20% of the color-coded resistance value of the original unit.

In rare cases, where close tolerance units are used as original equipment they are usually identified by a gold band for 5%, and a silver band for 10% tolerance. If a close-tolerance unit is required for replacement, two resistors, one higher and one lower than the required range, may be used in series or in parallel when matched for their combination resistance value.

If a 2-watt resistor is required and none is available from the jobber, two 1-watt units in series or in parallel will do the trick. Similarly, two 1/2-watt units can be used instead of one 1-watt. Any low-wattage unit can, of course, be replaced satisfactorily by any higher-wattage unit of the same range.

Correct ohmic values for combinations can easily be figured. Remember that when resistors are in series, their ohmic values add. When resistors are in parallel, the combined resistance is less than that of the lowest ohmic value in the group.

For equal-value resistors in parallel, the combined resistance is the value of one resistor divided by the number of resistors in parallel. The formulas are:

$$\text{In Series: } R = R_1 + R_2 + R_3, \text{ etc.}$$

$$R_1 \times R_2$$

$$\text{In Parallel: } R = \frac{R_1 + R_2}{R_1 \times R_2}$$

**POWER RESISTORS, WIRE WOUND**

All wire-wound resistors above the 2-watt size are becoming scarce because they are made of critical materials which must be conserved for war requirements. Fortunately, however, they are seldom required for service except in A.C.-D.C. sets.

If a wire-wound resistor of the required wattage rating is not available, a combination of any type of lower-wattage unit, either in series or parallel, may be substituted.

HALLICRAFTERS ★

HALLICRAFTERS ★



**LET'S ALL PITCH IN!**

WE CAN all help win this war by selling our government the communications receivers and equipment they need quickly and in sufficient quantities.

That is the reason I pay *highest cash prices* for used communications equipment.

When this war is over you will be in the market for new equipment and by taking advantage of my offer to purchase your present equipment at highest cash prices you will be in a position to buy new and better equipment than you now own.

Write, telephone or telegraph me description of your used communications receivers, transmitters and parts of standard make; you will be paid cash immediately without bother or red tape. I am particularly interested in *Hallcrafters*.

*I also have a store at 2335 Westwood Blvd., West Los Angeles, Calif.*

**Bob Henry, W9ARA**  
**HENRY RADIO SHOP**  
**BUTLER, MISSOURI**

**COMPLETE STOCKS**

I still have large stocks of receivers, 2 1/2 meter equipment, meters, tubes, transformers, resistors, condensers, panels, chassis, and radio parts of all sorts. I sell and rent code teaching equipment. Your orders and inquiries invited.

"WORLD'S LARGEST DISTRIBUTOR OF COMMUNICATIONS RECEIVERS"



**POPULAR ELECTRONICS**

(Continued from page 316)

- Controlling uniformity of color during printing runs (PE)
- Providing permanent unfading color records (PE)
- Measuring glare and opacity of paper (PE)
- Safety-first devices around presses (PE)
- Detecting and correcting press vibrations (PE)
- Automatic door-openers for binderies, shipping rooms, etc. (PE)
- Mailing-list analysts and sorters (PE)
- Automatic light-intensity control in printing and engraving plants (PE)
- Control of paraffine-vapor spray for preventing offset (PE)
- Grading of photographic negatives in gravure process (PE)
- Bleaching-process control (PE)
- Reclaiming of "white-water," control of digester, etc. (PE)
- Making engravings from photos by wire (PE)
- SAFETY DEVICES (PE)**
- Protection of punch-presses and other dangerous machines
- Protection of elevator doors, preventing car from starting unless all passengers are clear of threshold
- Transmission of weather maps to ships at sea
- Detection of icebergs, ships, etc., through fog
- Safety doors in mines
- Remote control of dangerous processes
- Protection of jails, penitentiaries, etc.
- Protection of electrical machinery
- Traffic-signal operation
- Auto speeding detectors
- Street-lighting control
- Burglary, kidnaping alarms
- Talking "rogues gallery" (sound pictures)
- Detection of gaseous gases in tunnels
- Hold-up protection, banks, etc. (closing of safety steel shutters)
- Fire alarms, smoke alarms
- Safety protection of oilburners
- Airway beacons
- Lighthouses and marker lamps
- Sewage treatment control
- Gunfire control
- HOME POSSIBILITIES**
- Controlling uniform illumination (PE)
- Monitoring oilburner pilot flame, to operate safety valve (PE)
- Garage and kitchen door openers (PE)

- Alarms against burglars and trespassers (PE, Osc.)
- Flood-lighting control (PE)
- Night-lights around house automatically turned on and off (PE)
- Automatic opening of refrigerator door (PE)
- Photographic exposure meter (PE)
- Electrical musical instruments (PE, Osc., Amp.)
- Window raising and closing mechanism (PE)
- Aids for invalids, the crippled, etc. (PE, Amp.)
- Kidnapping alarms for nurseries (PE, Amp.)
- COMMUNICATION**
- Radio broadcasting (Amp., Osc., Rect.)
- Point-to-point (Amp., Osc., Rect.)
- Ship-to-shore (Amp., Osc., Rect.)
- Ground-to-aircraft (Amp., Osc., Rect.)
- Police radio (Amp., Osc., Rect.)
- Trans-oceanic telephone and telegraph (Rect.)
- Communication with trans (Amp., Osc., Rect.)
- Supersonic; underwater (Amp., Osc., Rect.)
- Course and range finding (Amp., Osc., Rect.)
- Aids to navigation (Amp., Osc., Rect.)
- SPORTS**
- Timing races (PE)
- Foul-line for bowling alleys (PE)
- Timing of golf-swings (PE)
- Photo-electric shooting gallery (light-beam gun; photo cell as target) (PE)
- FOOD AND CHEMICAL PROCESSES**
- Control of level in tanks and bins (PE)
- Drinking-fountain control (PE)
- Turbidity control in water systems (PE)
- Cold-room door operation (PE)
- Automatic control of heat-treating (PE)
- Opening doors for animals (dairy, stables, etc. (PE)
- Tooth-paste filling machine (PE)
- Bottle fillers (PE)
- Metal-tube inspection (PE)
- Control of coffee roasters (PE)
- Candling eggs (PE)
- Moth control in orchards (PE)
- Synchronizing of two conveyors (PE)
- Sorting raisins at 1,000 per minute (PE)
- Sorting lemons, beans, etc. (PE)
- Eliminating green peaches from cannery stock (PE)
- Sorting cigars (PE)
- Control of acidity, alkalinity (PE)
- Testing oil (PE)
- Sludge-level indicator for sewage disposal plant (PE)
- Sterilizing foods (Osc.)
- Killing insects on plants (Osc.)

HALLICRAFTERS ★ HALLICRAFTERS

## ENGINEERS WANTED TRANSFORMER DESIGN ENGINEERS

Unusual opportunity with national manufacturer for several thoroughly experienced Transformer Design Engineers capable of Audio & Power up to 15 K.V.A.

### A WAR JOB—NOW: A FUTURE—LATER!

We are at present manufacturing vital war equipment for our fighting forces and our peace time activities and expansion program should provide steady employment and promotional opportunities to capable men.

Those now employed in war industry at full skill need not apply

Write to Personnel Manager

## FEDERAL TELEPHONE & RADIO CORP.

Manufacturing unit of the International Telephone and Telegraph Corp.

1000 Passaic Ave., E. Newark, N.J.

## A Guide to CATHODE RAY PATTERNS



Just Published!

**CATHODE RAY  
PATTERNS**  
Summarized  
IN ONE BOOK  
by MERWIN BLY  
39 pages  
Over 100 Charts

\$1.50

A real contribution to radio literature. The "Guide" presents under ONE cover a "sketch and caption" summary of cathode ray patterns in ready-to-use form that engineers and technicians appreciate. All patterns produced for the "Guide" were developed with conventional amplifiers and oscillators and viewed on a small oscilloscope using a standard circuit. A section on simple graphic analysis is included.

**5 DAYS' FREE APPROVAL**

John Wiley & Sons, Inc.  
440 Fourth Avenue, New York, N. Y.

Please send me a copy of Bly's A GUIDE TO CATHODE RAY PATTERNS on five days' approval. At the end of that time, if I decide to keep the book, I will remit \$1.50 plus postage; otherwise I will return the book postpaid.

Name .....

Address .....

Employed by .....

RC-2-43

## THE SUPER T.R.F.-NINE

(Continued from page 285)

quency of the incoming signal does not change within so small a movement. But, the frequency of the oscillator *does* change. However, the amount of change produced by the travel of the hand from the point O, to the point H, is so slight that there is still no practical *difference* between the *frequencies* of the two currents.

The two frequencies therefore still remain in phase and the program comes through at full gallop on the zero-beat.

Proceeding—when the hand has barely left the point H, moving in a clockwise direction, the continual divergence between the frequencies of the two currents reaches a separating point at "H" where a *practical difference in frequency* becomes operative.

As soon as this condition occurs, the RF signal current and the oscillator current, which now have different respective frequencies, heterodyne to form a beat frequency, better known as an intermediate frequency—the familiar I.F.

Now it is well known that such a beat frequency requires a second detector to convert the signal into audio form so that it can operate a speaker. But *this circuit has no second detector*. Therefore the beat frequency passes through the voice coil of the speaker in the form of alternating current, and the output is . . . SILENCE.

When the point of heterodyne (point H) is reached, the volume of the speaker will suddenly fall, due to the elimination of that amount of the signal which has been heterodyned with the oscillator current—and so filtered out. But there is still a residue of the signal left over which has escaped the heterodyning action. Even as in the regular process of amplification, the action of the grid is unable to convert all of the plate supply into alternating current; so here, there is still a residual amount of the RF signal which escapes the heterodyning action, and passes on to the speaker where it is faintly heard.

However, the signal has been so weakened by what has just taken place, that the original response curve, AOB, becomes drawn in and narrowed down to the shape indicated by the dotted line A'O'B'.

It is thus seen how the tuning becomes sharpened by the heterodyning action just set forth.

Here is an important point to consider at this stage of the explanation: If it can be so devised that the heterodyning process can be made more thorough, i. e. so that the RF signal can be nearly all destroyed, then the tuning could be made *very sharp*. Furthermore, and note well, *no matter how sharp the tuning might be made, this fact would in no manner cause cutting of the side-bands*.

Even if the curve A'O'B' were made as narrow as a needle, the side-bands still would not be cut.

This phenomenon is due to the fact that the curve A'O'B' is not formed, and does not become operative, until the station is nearly tuned out. When the station is fully tuned in, the curve A'O'B' does not exist; for the index hand is at the position "resonance" then the response curve AQB alone is operative; and since it represents a condition that provides ample broad tuning, therefore the side-bands cannot be cut—regardless of how sharp the tuning may be made.

Now the efficiency of the heterodyning action depends very largely upon the efficiency of the oscillator. Up to this date, the experimenter has been confined to the

use of the 6K7 tube, as is, and has been limited to the amount of local current that tube can supply.

What is needed is a tube that will supply a great amount of current that will be adjustable over a wide range of different current strengths.

### Parts List

#### MISCELLANEOUS:

Coils A and B—Miller 242RF.  
Oscillator coil C—Miller 242RF. (Altered)  
One two-gang broadcast tuning condenser, .000365  
One Class B—Push-pull input transformer  
One twelve inch P.M. speaker  
Tubes as shown on the diagram

#### RESISTORS:

3—100,000, 1 watt  
2—300, 1 watt  
1—2 megs, 1 watt  
1—1,000, 1 watt  
1—250,000, 1 watt  
1—500,000, 1 watt  
1—10,000, 1 watt  
1—50,000, 1 watt  
One 50,000 ohm potentiometer, 1 watt

#### CONDENSERS:

8—.1 mfd., tubular  
1—.05 mfd., tubular  
1—25 mfd. (electrolytic), tubular  
1—50 mmf., tubular

## LENZ' LAW IN MODERN SPEECH

(Continued from page 284)

one of the reasons why A.C. holds the lead over D.C. This little device with no moving parts just sits there and turns its own rheostats on and off to compensate for increased or decreased loads, without the switches, resistors and manual controls or relays needed in D.C. circuits.

### URNS AND IMPEDANCE RATIOS

We have noted that the voltage ratio—primary to secondary—varies as the turns ratio. If we have 2 turns in the secondary to 1 in the primary the voltage ratio is also 2 to 1.

There is another important relation between the primary and secondary—the impedance ratio of the two windings. The output transformer on your radio is not there for voltage reasons, but because the output tube has an impedance of (very roughly) 5000 ohms and the voice coil of the speaker may have an impedance of 4 ohms. The transformer is there to "match" these widely-varying impedances.

To get back to our lamp. The secondary has a current of ½ ampere at 115 volts, therefore an impedance (A.C. resistance) of 230 ohms. Since the primary is drawing the same current at the same voltage, it also has an impedance of 230 ohms—reflected back from the secondary.

It might be better to speak of conductances here rather than impedances—as it is obviously conductance that is reflected back. But the effect is always called a "reflected impedance", probably because it is more convenient to deal with the impedance than with the conductance, in mathematical calculations.

Suppose we have a secondary with 230 turns instead of 115. Then we can hook up two 60-watt bulbs in series, each drawing ½ ampere at 115 volts. The secondary impedance is now 460 ohms. But our primary is still on 115 volts and we find it drawing 1 ampere, as we should expect, as it is lighting two 60-watt bulbs. The impedance reflected back is 115 ohms, or ¼ the impedance of the secondary.

Increasing the secondary to 345 turns and hooking in three 60-watt bulbs would give us a secondary of 690 ohms impedance. The

(Continued on page 320)

# Book Reviews

## AIR RAID ALARMS

(Continued from page 271)

sections (See Figs. 1a, 1b, 1c.) as follows:

1. The detector.
2. Selective circuit.
3. Relay circuit.

The detector tube is a 955, or a 954, or some similar type, used in a super-regenerative circuit. The sensitivity is adjustable so as to conform as much as possible with variations encountered in localities where the signal ratio may be above or below the requirements for proper operation.

The output of the detector feeds into a three-section filter circuit. Each filter section is very sharply tuned to one of the transmitted pulse frequencies, as given in the example, 7,000, 11,000 and 13,000 cycles. (See Fig. 1b.)

The combined output from the filter circuit feeds into a thyatron type of tube. The output of the thyatron tube connects to a stepping relay, and several other relays that control the power line relay for turning the power line on and off.

Three stepping relays are used, with 10 contacts on each, but actually only 3 contacts on each are used.

The contacts that are to be used are determined by the code that is to be installed. The code in turn is determined by the man in charge of the alarm system and its broadcast. After the code has been set and the connections have been made, the device will naturally function only when the proper sequence of signals is received.

Since the setting of the code is done manually it may leave room for sabotage or information leakage of the code that is being used. However, this hazard can be reduced by the use of an automatic coder system, which permits the selection of code signals entirely by mechanical means. The arrangement of signals can be sealed within an automatic coder and all that has to be done is to start the coder by means of a push-button, and a new selection of code signal arrangement will automatically be set at the receiver.

Of course, if the automatic coder is to be used, an additional filter circuit is required in the receiver, and one more pulse frequency will be needed at the transmitter. This additional feature raises the cost of the device, but the cost may be justified in certain installations.

### SUMMARY

In summing up, we readily see that with this device all disadvantages have been overcome. The receiver unit is sealed and locked and installed in such a manner that only the proper person can have access to the device. As an additional feature, the design is such that anyone tampering with the unit will cause the power line circuit to be interrupted and no end of messing around with it will restore operation.

Interference of any nature, such as static, lightning, heterodyne beats or other forms of disturbances will not cause the receiver to function.

Only the proper code will give action in the receiver. The chances of receiving a coded signal as demanded are indeed very remote, and can be neglected.

### PULSES ENHANCE UTILITY

Due to the use of pulses for the operation of the unit another feature is noteworthy, that is, certain design features in the control unit permit functions heretofore not feasible. But since the actual operation is still a little secret, the aforementioned features can only be mentioned, and no data given. The form and time element of the pulse can

(Continued on page 320)

**SHORT-WAVE RADIO**, by J. H. Reyner. Published by Sir Isaac Pitman & Sons, Ltd. Stiff cloth covers, size 5 x 7½ inches, 186 pages. Price \$3.25.

This compact little work discusses the art in simple, direct up-to-date terms and presents the very latest material.

It is devoid of long, technical or mathematical discussions, and has plenty of illustrations and diagrams, to illustrate the ideas and concepts that are to be noted.

An interesting feature is the glossary at the beginning of the book (instead of at the end, where it is so often overlooked), which enables the reader to get straight the exact meaning of the terms used.

The author explains what short waves are to begin with, and what range (or spectrum) they now cover.

How the waves are propagated is clearly explained, as well as the different types of aeriels and arrays commonly employed. Easily understandable drawings help this dissertation immensely.

Beverage, zigzag, inverted-V, and polarized receiving antennae are covered, with examples of their practical use.

The short wave transmitter takes up a good portion of the work and acquaints the reader with all the modern set-ups.

Modulation, which has undergone so much experiment and development these past ten years, comes in for compact discussion.

Short-wave receivers, U.H.F., FM, and microwaves are covered last, but in the same interesting manner as the preceding material.

Altogether this is a handy little work. For those who do not have the time to read everything on short waves, this book will bring them up-to-date rapidly.

**PRINCIPLES OF ELECTRONICS**, by Royce G. Kloeffler. Published by John Wiley & Sons, Inc. Stiff cloth covers, size 6 x 9 inches, 175 pages. Price \$2.50.

For the average experimenter, radio set builder, serviceman, ham, radio development and test worker, here is a book which they can all use and enjoy.

Heretofore in order to read up on electronics one had to consult books, which, while excellent and complete in every way, were a little bit over the head of the man who was not an electrical engineer.

This book ends all that, for its content consists of extracts from current literature, supplemented by notes and lectures which were needed to instruct electrical engineering students at the sophomore level.

The needs of the armed forces for men skilled in radio, has required that these men have a firm background in radio theory and communications principles, and a working knowledge of electronics, with the accent on the modern concept of electrons as the sources and carriers of currents. The old analogies, hypotheses, and guesses, are "out" for good.

Therefore if a man takes up this book with this fresh viewpoint he will be amazed at the worlds of knowledge that it opens up to him.

Starting with the atom, the work progresses through the electron, current flow, emission in a vacuum and in gases; con-

trol-grid action; amplification; industrial electronic devices; the electron microscope; the cathode-ray tube; photoelectric cells; oxide rectifiers; and applications of special apparatus and devices.

There are no mathematics involved, and there are plenty of drawings. Drawings that convey the information clearly and forcefully.

No radio man should be without this book.

**PRINCIPLES OF AERONAUTICAL RADIO ENGINEERING**, by P. C. Sandretto. Published by McGraw-Hill Book Company, Inc. Stiff cloth covers, 6 x 9 inches, 414 pages. Price \$3.50.

Thousands of young men these days are entering the armed forces, many of them with their eyes on the air branches. Many of them, technicians of one sort or another, are avidly interested in "getting a line" on what is required in the way of background knowledge of their specialty.

This work on radio engineering as applied to the special problems in aeronautics, is, so far as is known, the first of its kind. While it is based on practice in commercial lines, its data can be extended to the military application. Naturally all material of a secret nature will not be found in it.

It is not a beginner's book. The man who approaches this must have a good solid background in standard radio engineering, such as is given in the pre-service training schools.

The field covered embraces Avigation, Communications and Accessories. Under Avigation (which means getting along in the dark, rain, fog or snow, as contrasted to navigation in clear weather) can be found data on radio range, direction finding, markers, instrument landings, absolute altimeters, and direction-finding from ground stations.

Under Communications the transmitting and receiving equipment is covered in excellent detail, while under Accessories will be found all data pertaining to the electrical system, design considerations, transducers, etc.

In our opinion, this work fills a long-felt want and should have wide application.

**MATHEMATICAL RECREATIONS**, by Maurice Kraitchik. Published by W. W. Norton & Co., Inc. Stiff cloth covers, 5½ x 8½ inches, 328 pages. Price \$3.75.

As the name implies, this is not a technical book. It's for those who like to do mental tricks.

To a great many the word "mathematics" means "figuring"; to others it seems to have a paralyzing or terrifying effect.

But actually people seem to enjoy exercising their reasoning powers in mathematical riddles, puzzles and games. Possibly because they will not be "held to account" for the answer, such as they are in real life or in school.

So this book brings together an endless variety of such pastimes, from the most famous as well as the most obscure sources. The ancient and curious problems of the old French schools, and the Arabian and Hindu origins have been tapped.

There are problems involving the guess-

(Continued on following page)

# BOOK REVIEWS

## NOW—A REALLY HIGH-POWERED— Radio Engineering Library

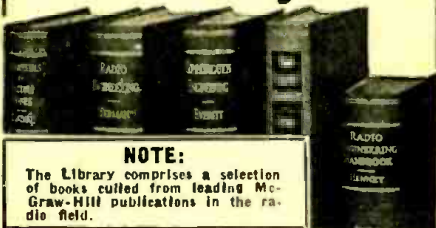

### NOTE:

The Library comprises a selection of books culled from leading McGraw-Hill publications in the radio field.

- especially selected by radio specialists of McGraw-Hill publications
- to give most complete, dependable coverage of facts needed by all whose fields are grounded on radio fundamentals
- available at a special price and terms

THESE books cover circuit phenomena, tube theory, networks, measurements, and other subjects—give specialized treatments of all fields of practical design and application. They are books of recognized position in the literature—books you will refer to and be referred to often. If you are a practical designer, researcher or engineer in any field based on radio, you want these books for the help they give in hundreds of problems throughout the whole field of radio engineering.

**5 VOLUMES, 3319 PAGES, 2289 ILLUSTRATIONS**

1. Eastman's FUNDAMENTALS OF VACUUM TUBES
2. Terman's RADIO ENGINEERING
3. Everitt's COMMUNICATION ENGINEERING
4. Hund's HIGH FREQUENCY MEASUREMENTS
5. Henney's RADIO ENGINEERING HANDBOOK

10 days' examination. Easy terms. Special price under this offer less than books bought separately. Add these standard works to your library now; pay small monthly installments, while you use the books.

**10 DAYS' FREE EXAMINATION—SEND COUPON**

McGraw-Hill Book Co., 330 W. 42nd Street, N. Y. C.

Send me Radio Engineering Library, 5 vols., for 10 days' examination on approval. In 10 days I will send \$3.00 plus few cents postage, and \$3.00 monthly till \$24.00 is paid, or return books postpaid. (We pay postage on orders accompanied by remittance of first installment.)

Name .....

Address .....

City and State .....

Position .....

Company ..... RC 2-43

## Headset Headquarters



Our Headphones are used by the United States, Canadian, New Zealand and South African Governments as well as other Governments not directly in the war. Folder C-2 illustrates rugged, unusually sensitive, dependable Cannon-Ball Headsets.

Scientifically Built  
Heavy bar magnets greatly increase efficiency.

Write .....  
**C. F. CANNON COMPANY**  
SPRINGWATER, N. Y.

absolutely **FREE!**



• Yes, the Aerovox Research Worker can be mailed to you month after month, absolutely free! Chuckful of latest radio and electronic data, charts, formulae, diagrams, suggestions. Simply indispensable in your work.  
• Ask local jobber about a free subscription. • Or write Aerovox Corporation, Dept. RC, New Bedford, Mass.

## Book Reviews

(Continued from page 319)

ing of unknown numbers; and examples of crypt-arithmetic (the use of letters in place of figures).

Many of the problems can be solved by a boy or a girl, interested in arithmetic only. Others in the middle range will satisfy the average adult; and for those trained mathematicians who like a little mathematical "diversion" there are some that will really try their talents.

## AIR RAID ALARMS

(Continued from page 319)

be taken into consideration for the operation of the relay circuits in the receiver. A timing circuit can be provided that responds only to a given time limit. Any deviation from this time limit will not permit certain functions to take place.

As the art progresses we will make more and more use of electronic developments for everyday existence, and it is the writer's belief that some day a lot of other uses will manifest themselves where a device of the nature as described in this article will show its advantages.

## LENZ' LAW IN MODERN SPEECH

(Continued from page 318)

primary impedance would be 80 ohms roughly, or one-ninth the secondary impedance.

The rule is that the impedance ratio varies as the square of the voltage ratio, as you can prove by trying (or estimating) voltage ratios of 4:1 and 5:1 and noting the currents and impedances.

## CHOKES, SPARK COILS, AND R.F. COILS

There are other applications of the magnetic field. A single coil on an iron core may be used to "choke" out remaining A.C. in the D.C. from the rectifier tube in your receiver. As has been shown, such a coil will have no effect on D.C. once the flow is started; but if the current tries to increase, the increasing magnetic field will tend to shove it back. If the current decreases, the field in weakening will actually supply a little current to the coil to help out the current already there. Thus the pulsations are smoothed down—parts of the peaks actually used as energy to fill up the hollows, with the result that one or two good-sized chokes will take the hum out of a very rough rectified A.C. current.

A single spark coil is another application. This is also simply a coil on an iron core. Current is supplied to it and suddenly cut off. The magnetic field disappears instantaneously. It is as if you pulled the core out of the coil with infinite speed. A very high voltage is of course set up, creating a nice fat spark if everything is going right.

Radio coils are a slightly different proposition. The iron core in the 60-cycle coil insures that the whole magnetic field set up by the current remains around the coil. That is why a voltage of 115 sets up a counter-voltage of 114 plus in some cases. The air core of the radio coil offers very poor assistance to magnetism, with the result that a radio secondary may only get a few percent of the field surrounding the primary.

The high frequencies used in radio further complicate matters, so that turns-ratio by itself means little in radio coils.

It is, however, possible to calculate voltage ratios and impedance ratios in these coils. To do this we must know something about the condenser and resonance. This may form the subject of a following article.



HIGH EFFICIENCY results in Sound National Defense that is why NATIONAL DEFENSE SOUND SYSTEMS are equipped with University Reflex HIGH POWER LOUDSPEAKERS UNIVERSITY LABS. 195 CHRYSTIE ST. N. Y. C.

## Index to advertisers

|   |                    |
|---|--------------------|
| Aerovox Corporation                       | 320                |
| Allied Radio Corp.                        | 260                |
| Amperite Corporation                      | 260                |
| Audel & Co., Theo.                        | Back Cover         |
| Audiograph                                | 306                |
| Candler System Company                    | 304                |
| Cannon Co., C. F.                         | 320                |
| Chartered Institute of America            | 314                |
| Commercial Radio Institute                | 304                |
| Coyne Electrical School                   | 259                |
| Embry-Riddle School of Aviation           | 316                |
| Federal Telephone and Federal Radio Corp. | 318                |
| General Cement                            | 290                |
| Gold Shield Products                      | 312, 314           |
| Hallicrafters, Inc.                       | Inside Front Cover |
| Harrison Radio                            | 314                |
| Henry Radio                               | 317                |
| Hudson Specialties Company                | 309                |
| International Projectionist               | 304                |
| Lancaster, Allwine & Rommell              | 314                |
| Lincoln Engineering School                | 316                |
| Mass. Radio School                        | 316                |
| McGraw-Hill Book Co.                      | 320                |
| Meissner Manufacturing Co.                | 292                |
| Mirror Record Corp.                       | 316                |
| National Radio Institute                  | 257                |
| National Union Corp.                      | 301                |
| Nelson Company                            | 306                |
| N. Y.-Y. M. C. A. Schools                 | 316                |
| Ohmite                                    | 261                |
| Opportunity Adlets                        | 306                |
| Popular Homecraft                         | 306                |

## RADIO SCHOOL DIRECTORY

- American Radio Institute
- Capitol Radio Engineering Institute
- Electronic Radio-Television Institute
- Melville Aeronautical Radio School, Inc.
- Metropolitan Technical School
- N. Y. Y. M. C. A. Schools
- N. Y. Technical Institute
- Nilson Radio School
- RCA Institute
- Radio-Television Institute
- Radio & Technical Publishing Company
- Triplett Electrical Instrument Co.

|                             |               |
|-----------------------------|---------------|
| Radcraft Publications, Inc. | 262, 303, 305 |
| Radio Publications          | 315           |
| Radio & Television          | 310, 312      |
| Readrite Meter Works        | 290           |
| Solar Manufacturing Co.     | 316           |
| Sprayberry Academy of Radio | 287           |
| Supreme Instruments Corp.   | 306           |
| Technifax                   | 287, 293, 313 |
| Teleplex Co.                | 304           |
| University Laboratories     | 320           |
| Wiley & Sons, Inc., John    | 318           |

(While every precaution is taken to insure accuracy, we cannot guarantee against the possibility of an occasional change or omission in the preparation of this index.)

# FOR VICTORY TODAY AND SOUND BUSINESS TOMORROW

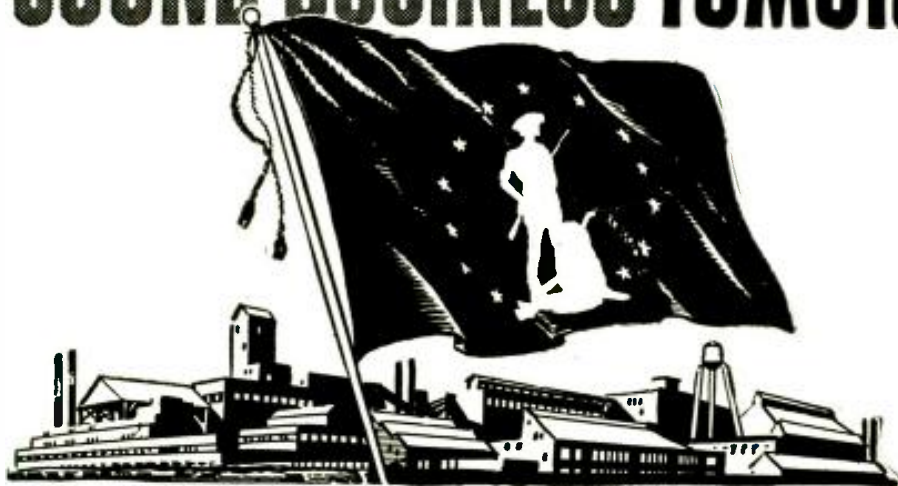

## *Get This Flag Flying Now!*

This War Savings Flag which flies today over companies, large and small, all across the land means *business*. It means, first, that 10% of the company's gross pay roll is being invested in War Bonds by the workers voluntarily.

It also means that the employees of all these companies are doing their part for Victory . . . by helping to buy the guns, tanks, and planes that America and her allies *must* have to win.

It means that billions of dollars are being diverted from "bidding" for the constantly shrinking stock of goods available, thus putting a brake on inflation. And it means that billions of dollars will be held in readiness for post-war readjustment.

Think what 10% of the national income, saved in War Bonds now, month after month, can buy when the war ends!

For Victory today . . . and prosperity *tomorrow*, keep the War Bond Pay-roll Savings Plan rolling in *your* firm. Get that flag flying now! Your State War Savings Staff Administrator will gladly explain how you may do so.

If your firm has not already installed the Pay-roll Savings Plan, *now is the time to do so*. For full details, plus samples of result-getting literature and promotional helps, write or wire: War Savings Staff, Section F, Treasury Department, 709 Twelfth Street NW., Washington, D. C.



Save With  
**War Savings Bonds**

This Space Is a Contribution to America's All-Out War Program by

**RADIO—CRAFT**

# PRACTICAL RADIO INFORMATION

**Including Frequency Modulation—Television, etc.**

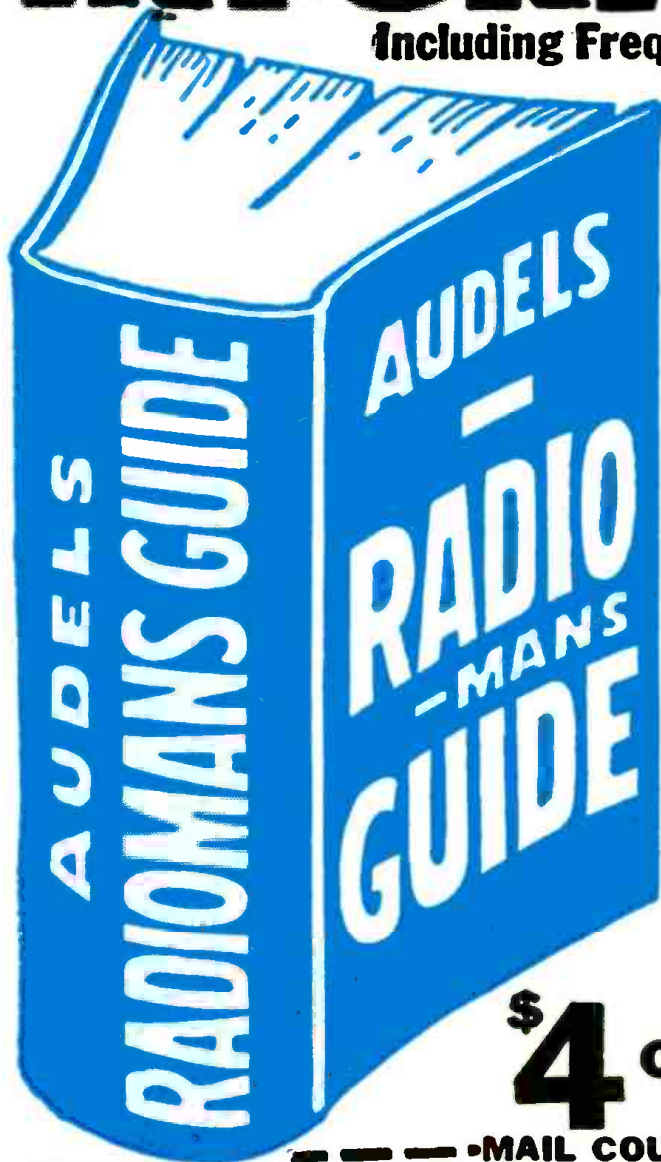

Inside Information for all Servicemen—Aircraft Pilots, Students.

**772 PAGES, 400 DIAGRAMS**

is complete—gives Authentic Principles & Practices in Construction, Operation, Service & Repairs. Covers clearly and concisely Radio fundamentals—Ohm's Law—Physics of sound as related to radio science—Measuring instruments—Power supply—Resistors—Inductors—Condensers—Transformers and examples—Broadcasting stations—Radio Telephony—Receivers—Diagrams—Construction—Control systems—Loud speakers—Antennas—Auto Radio—Phonograph pickups—Public Address Systems—Aircraft & Marine Radio—Radio Compass—Beacons—Automatic Radio Alarms—Short Wave—Coil Calculations—Testing—Cathode ray oscillographs—Static Elimination—Trouble Pointers—Underwriter's standards—Units & tables. REVIEW QUESTIONS—Ready Reference Index.

**\$4 COMPLETE • PAY \$1 A MO.**  
To get this practical information in handy form—Fill in and

— — — — — MAIL COUPON TODAY — — — — —

**AUDEL, Publishers; 49 West 23rd St., New York**  
Mail AUDELS NEW RADIOMAN'S GUIDE for free examination. If O. K. I will send you \$1 in 7 days; then remit \$1 monthly until \$4 is paid. Otherwise I will return it.

Name .....

R.C.F.

Address .....

Occupation .....

Reference .....

Please Note:  
If you do not wish to mar this page by clipping coupon—send letter or penny postcard instead.